

Pin	A	B	C
2	2.50	10.00	8.30
3	5.00	12.50	10.80
4	7.50	15.00	13.30
5	10.00	17.50	15.80
6	12.50	20.00	18.30
7	15.00	22.50	20.80
8	17.50	25.00	23.30
9	20.00	27.50	25.80
10	22.50	30.00	28.30
11	25.00	32.50	30.80
12	27.50	35.00	33.30
13	30.00	37.50	35.80
14	32.50	40.00	38.30
15	35.00	42.50	40.80
16	37.50	45.00	43.30

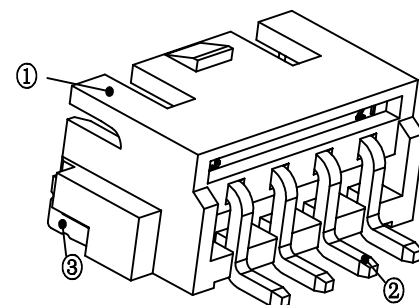

技术参数

间距: 2.5  
 温度范围: -25~+85°C  
 额定电压: 250V AC, DC  
 额定电流: 3.0A AC, DC  
 接触电阻: 20mΩ  
 绝缘电阻: 800MΩ  
 耐压: 500V AC/minute

线性公差 / General Tolerance	
X	±0.2
X.X	±0.1
X.XX	±0.05
角度公差 / Angle Tolerance	
X°	±5.0°
X.X°	±3.0°
X.XX°	±1.0°

视角 / Projection



A1	调整平面度	周建松	2021/11/16
标记	变更内容	签名	年月日
绘图	张银溪 191012		
审核	周建松 191013		
工艺		批准	周建松 191013

材料 / Material

- ①塑座: LCP 本色
- ②接触针: 黄铜 (镀锡)
- ③焊片: 黄铜 (镀锡)

单位 (Units) 版本 比例

mm 2.0 1:1

共 1 张 第 1 张

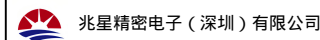

品名 / ProduceName

HA2.54 卧贴 7P

型号 / Model

ZX-HA2.54-7PWT