

2~4A

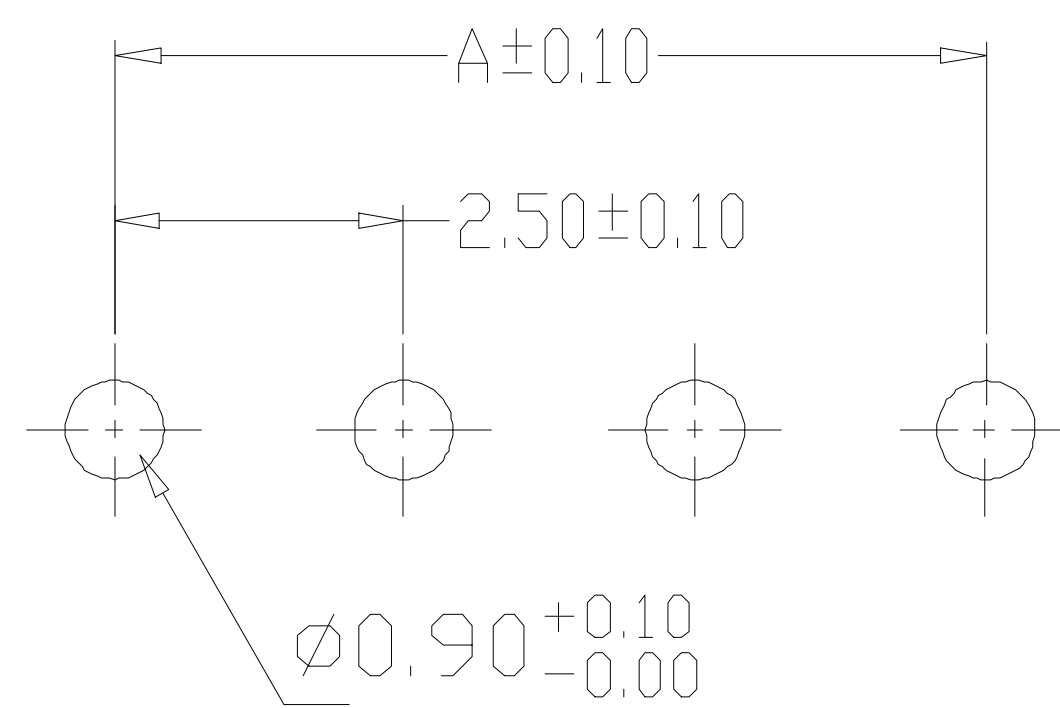

PCB LAYOUT

SPECIFICATIONS

- 1、Current Rating: 3A AC, DC
- 2、Voltage Rating: 250V AC, DC
- 3、Temperatuer Range: -25°C~+85°C
- 4、Contact Resistance: 20mΩ Max
- 5、Insulation Resistance: 1000MΩ Min
- 6、Withstanding Voltang: 1000V AC/minute
- 7、Material: Wafer Nylon66, UL94V-0
PIN Brass Tin-plated

编 号	尺寸 (mm)	
	A	B
A2504-02AW	2.50	7.50
A2504-03AW	5.00	10.00
A2504-04AW	7.50	12.50
A2504-05AW	10.00	15.00
A2504-06AW	12.50	17.50
A2504-07AW	15.00	20.00
A2504-08AW	17.50	22.50
A2504-09AW	20.00	25.00
A2504-10AW	22.50	27.50
A2504-11AW	25.00	30.00
A2504-12AW	27.50	32.50
A2504-20AW	47.50	52.50

制图 DRAWN	变更内容 DESCRIPTION	日期 DATE	GENERAL TOLERANCE		制图 DRAWING	料号 PART NO.	ZX-HA2.54-3PWZ	版本 REV.	A
			X±0.25	X°±2°					
.X±0.20	.X°±1°								
			.XX±0.15	.XX°±0.5°					
			.XXX±0.10	.XXX°±0.5°					