

Kinghelm®

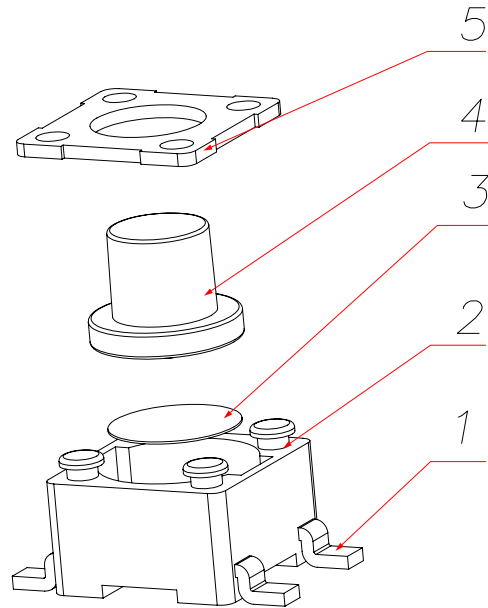
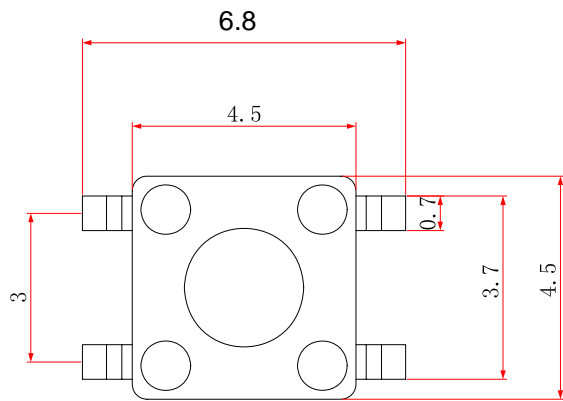
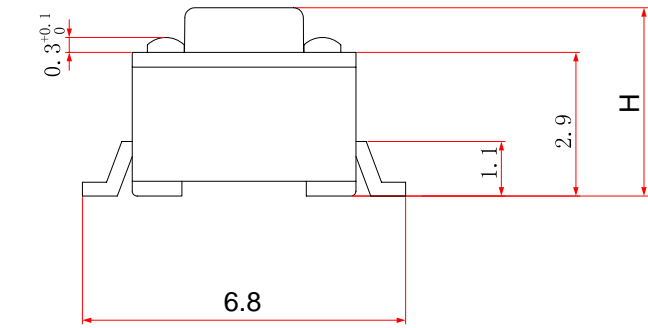

尺寸范围	未注公差值
0~3	±0.1
3~6	±0.15
6~9	±0.2
9~12	±0.25
12~15	±0.3

5	盖板	铁	镀银	——
4	帽头	PPA	黑色	——
3	簧片	覆银	——	——
2	底座	PPA	黑色	——
1	嵌件	黄铜	镀银	——
	名称 DESCRIPTION	材料 MATERIAL	颜色 COLOR	备注 REMARK

CUSTOMER COPY		名稱 TITLE: 4.5贴片-外形图	
型號 TYPE NO.		TSTP45H	
材料 MATERIAL			
圖號 DRAWING NO.	A 狀態碼	ARAM3.608.025WX	
SCALE	5:1	UNIT	mm
		A4	

深圳市金航标电子有限公司		www.kinghelm.com.cn		DESIGN	設計		
KH-4.5X4.5X6.5H-SMT		0755-83044319		CHECK	校閱		
PA	08/01/09			CHECK	审定		
工程變更通知單 ECN(DCN) NO.	版次 REV.	日期 DATE	說明 DESCRIPTION	改變 CHANGE	承認 APPRO.	GENERAL TOLERANCE UNLESS OTHERWISE NOTED	APPRO.