

产品

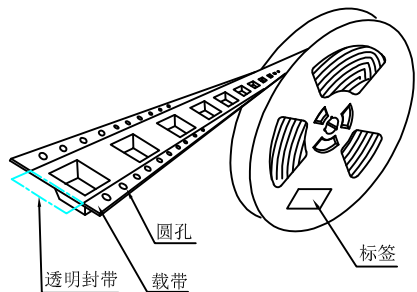

透明封带  
载带

圆孔

标签

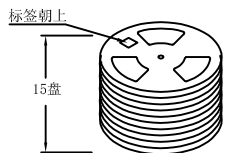

标签朝上

15盘

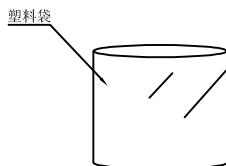

塑料袋

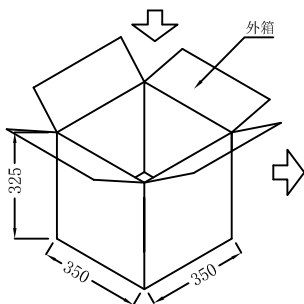

外箱

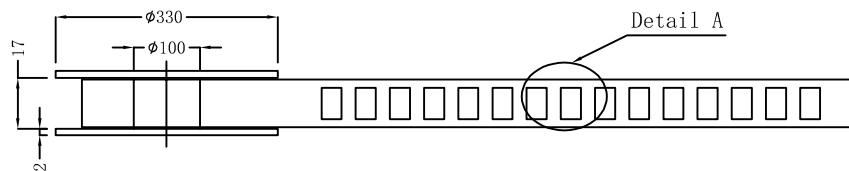
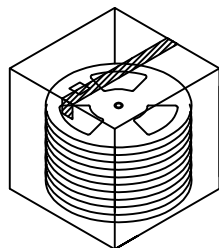

Detail A

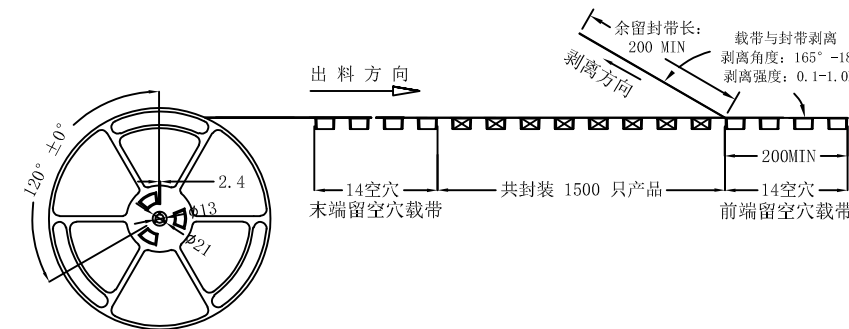

出料方向

剥离方向

余留封带长:  
200 MIN

载带与封带剥离  
剥离角度: 165° -180°  
剥离强度: 0.1-1.0N

14空穴 共封装 1500 只产品 14空穴  
末端留空穴载带 前端留空穴载带

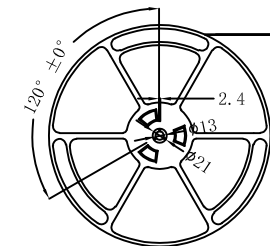

120° ±0°

2.4

φ13

φ21

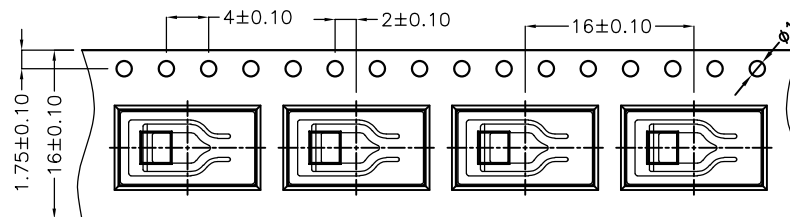

4±0.10 2±0.10 16±0.10

1.75±0.10 16±0.10

2.7±0.10

0.3±0.10

7.1±0.10

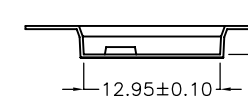

Detail A



工程 部

2022-08-06

H. WANG

技术要求:

1. 圆孔十个孔距离累计允许公差为±0.2mm
2. 带长250mm内容许弯曲度1mm
3. 材料厚度以在载带边缘测量为准
4. 所有尺寸定义依循EIA-481-C系准则定义之
5. 材料: 黑色PS T=0.30±0.05mm
6. 所有卷轮为灰蓝挖空旋转塑胶卷轮
7. 整模成型长度: 24.48M,
8. 非指明公差范围为: ±0.1mm; 超过250mm不计算累计误差
9. 型腔外形凡未标明处倒角R为0.2-0.3; 拔模斜度未标注的为3° 以下

包装信息:

- 1、每卷盘装产品1500 只, 卷盘外侧贴相关标签;
- 2、每 15 卷盘放在一个塑料袋中;
- 3、每外箱装15盘, 产品总数: 22500 只;
- 4、外箱上下用胶纸封成“工”字;

UNLESS OTHERWISE SPECIFIED TOLERANCES		<b>MYOUNG 美阳</b> www.meiyangdz.com					
DECIMALS: X.X : ±*** X.XX : ±*** X.XXX : ±***	ANGLES: X : ±*** X.X : ±***	DSND	YangFeng	DATE	2022-08-06	TITLE:	电池弹片-115负极 SMT 卷装
		CHKD	ZhouRuicai	DATE	2022-08-06		
		APVD	XueShun Yong	DATE	2022-08-06	PART NO.:	MY-FJ-115-R
WEIGHT:		SCALE: 1:1	SIZE: A4	VIEW:			
SHEET 1 OF 1		UNIT: mm	REV.: A/0	OBJECT: MY	DRAW NO.: MY-BD-0031		