

Single N-Channel Enhancement Mode MOSFET

Feature

- 60V/210A
 $R_{DS(ON)} = 1.6 \text{ m}\Omega$ (typ.) @ $V_{GS} = 10\text{V}$
- 100% Avalanche Tested
- Reliable and Rugged
- Halogen-Free Devices Available (RoHS Compliant)

Pin Description

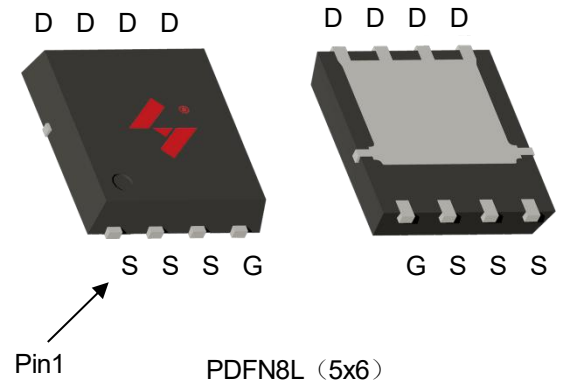

Applications

- High Frequency Point-of-Load Synchronous Buck Converter
- Power Tool Application
- Networking DC-DC Power System

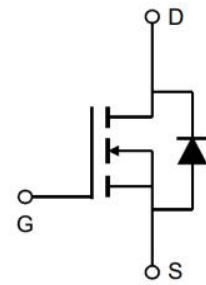

Single N-Channel MOSFET

Ordering and Marking Information

| | |
|---|--|
|  C2 G019N06 XYMXXXXXX | Package Code C2: PDFN8L (5x6) Date Code XYMXXXXXX |
|---|--|

Note: HUAYI lead-free products contain molding compounds/die attach materials and 100% matte tin plate Termination finish; which are fully compliant with RoHS. HUAYI lead-free products meet or exceed the lead-free requirements of IPC/JEDEC J-STD-020 for MSL classification at lead-free peak reflow temperature. HUAYI defines "Green" to mean lead-free (RoHS compliant) and halogen free (Br or Cl does not exceed 900ppm by weight in homogeneous material and total of Br and Cl does not exceed 1500ppm by weight).

HUAYI reserves the right to make changes, corrections, enhancements, modifications, and improvements to this product and/or to this document at any time without notice.

Absolute Maximum Ratings

| Symbol | Parameter | | Rating | Unit |
|--|--|----------|------------|------|
| Common Ratings (Tc=25°C Unless Otherwise Noted) | | | | |
| V _{DSS} | Drain-Source Voltage | | 60 | V |
| V _{GSS} | Gate-Source Voltage | | ±20 | V |
| T _J | Maximum Junction Temperature | | 175 | °C |
| T _{STG} | Storage Temperature Range | | -55 to 175 | °C |
| I _S | Source Current-Continuous(Body Diode) | Tc=25°C | 210 | A |
| Mounted on Large Heat Sink | | | | |
| I _{DM} | Pulsed Drain Current * | Tc=25°C | 720 | A |
| I _D | Continuous Drain Current | Tc=25°C | 210 | A |
| | | Tc=100°C | 148.5 | A |
| P _D | Maximum Power Dissipation | Tc=25°C | 166.6 | W |
| | | Tc=100°C | 83.3 | W |
| R _{θJC} | Thermal Resistance, Junction-to-Case | | 0.9 | °C/W |
| R _{θJA} | Thermal Resistance, Junction-to-Ambient ** | | 47 | °C/W |
| E _{AS} | SinglePulsed-Avalanche Energy *** | L=0.3mH | 702.2 | mJ |

Note: * Repetitive rating; pulse width limited by max.junction temperature.

** Surface mounted on FR-4 board.

*** Limited by T_{Jmax}, starting T_J=25°C, L = 0.3mH, V_{DS} =48V., V_{GS} =10V.

Electrical Characteristics(Tc =25°C Unless Otherwise Noted)

| Symbol | Parameter | Test Conditions | HYG019N06LS1 | | | Unit |
|-------------------------------|----------------------------------|---|--------------|------|-----|------|
| | | | Min | Typ. | Max | |
| Static Characteristics | | | | | | |
| BV _{DSS} | Drain-Source Breakdown Voltage | V _{GS} =0V, I _{DS} =250μA | 60 | - | - | V |
| I _{DSS} | Drain-to-Source Leakage Current | V _{DS} =60V, V _{GS} =0V | - | - | 1 | μA |
| | | T _J =100°C | - | - | 50 | μA |
| V _{GS(th)} | Gate Threshold Voltage | V _{DS} =V _{GS} , I _{DS} =250μA | 1.5 | 2.4 | 3.0 | V |
| I _{GSS} | Gate-Source Leakage Current | V _{GS} =±20V, V _{DS} =0V | - | - | 100 | nA |
| R _{DS(ON)*} | Drain-Source On-State Resistance | V _{GS} =10V, I _{DS} =50A | - | 1.6 | 2.2 | mΩ |
| Diode Characteristics | | | | | | |
| V _{SD*} | Diode Forward Voltage | I _{SD} =50A, V _{GS} =0V | - | 0.83 | 1.2 | V |
| t _{rr} | Reverse Recovery Time | I _{SD} =50A, dI _{SD} /dt=100A/μs | - | 42 | - | ns |
| Q _{rr} | Reverse Recovery Charge | | - | 54.6 | - | nC |

Electrical Characteristics (Cont.) (T_c =25°C Unless Otherwise Noted)

| Symbol | Parameter | Test Conditions | HYG019N06LS1 | | | Unit |
|------------------------------------|------------------------------|---|--------------|------|-----|------|
| | | | Min | Typ. | Max | |
| Dynamic Characteristics | | | | | | |
| R _G | Gate Resistance | V _{GS} =0V, V _{DS} =0V, F=1MHz | - | 0.68 | - | Ω |
| C _{iss} | Input Capacitance | V _{GS} =0V, V _{DS} =25V, Frequency=1.0MHz | - | 5044 | - | pF |
| C _{oss} | Output Capacitance | | - | 1150 | - | |
| C _{rss} | Reverse Transfer Capacitance | | - | 40.4 | - | |
| t _{d(ON)} | Turn-on Delay Time | V _{DD} =30V, R _G =2.5Ω, I _{DS} =50A, V _{GS} =10V | - | 17.9 | - | ns |
| T _r | Turn-on Rise Time | | - | 59.9 | - | |
| t _{d(OFF)} | Turn-off Delay Time | | - | 41.2 | - | |
| T _f | Turn-off Fall Time | | - | 43.6 | - | |
| Gate Charge Characteristics | | | | | | |
| Q _g | Total Gate Charge | V _{DS} =48V, V _{GS} =10V, I _D =50A | - | 79.2 | - | |
| Q _{gs} | Gate-Source Charge | | - | 24.4 | - | |
| Q _{gd} | Gate-Drain Charge | | - | 13.6 | - | |

Note: *Pulse test, pulse width ≤ 300us, duty cycle ≤ 2%

Typical Operating Characteristics

Figure 1: Power Dissipation

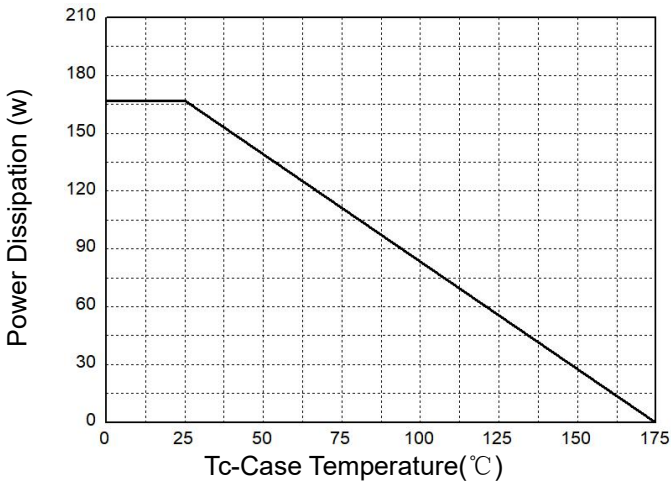

Figure 2: Drain Current

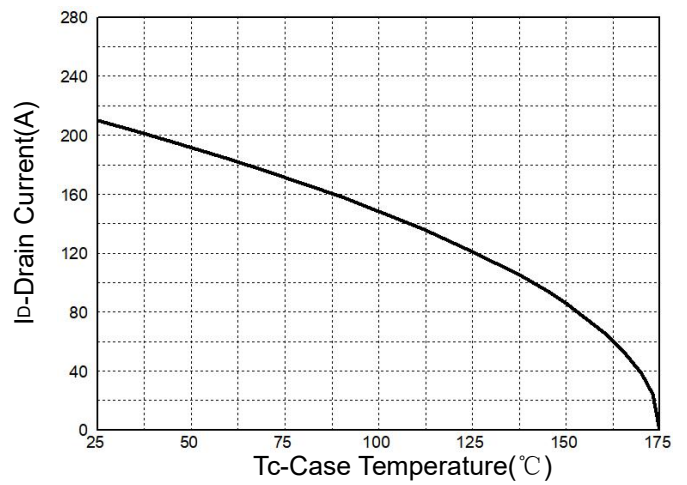

Figure 3: Safe Operation Area

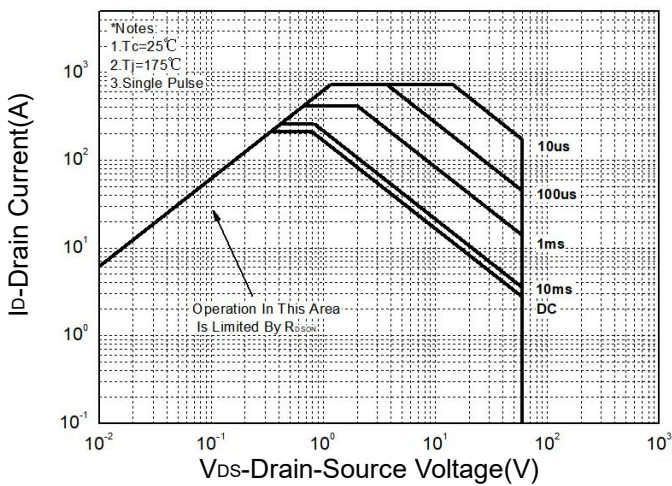

Figure 4: Thermal Transient Impedance

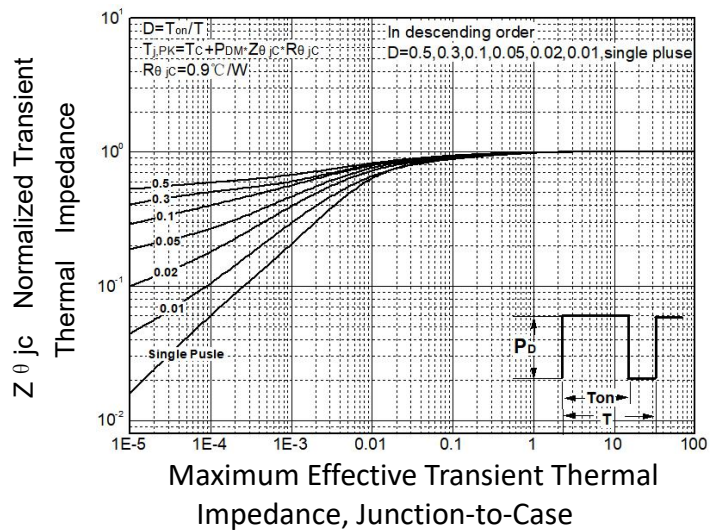

Figure 5: Output Characteristics

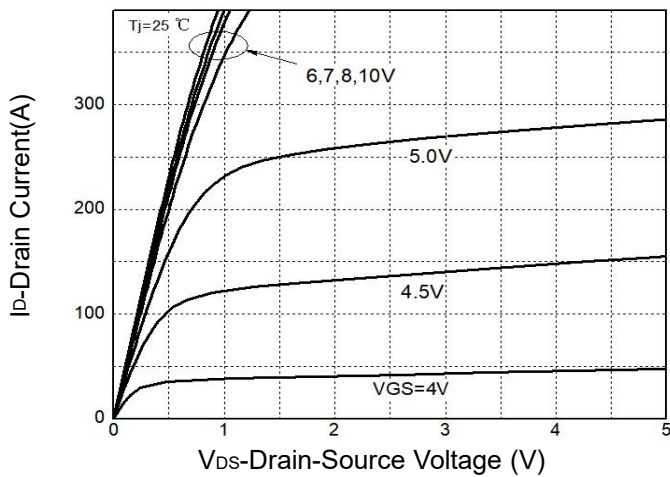
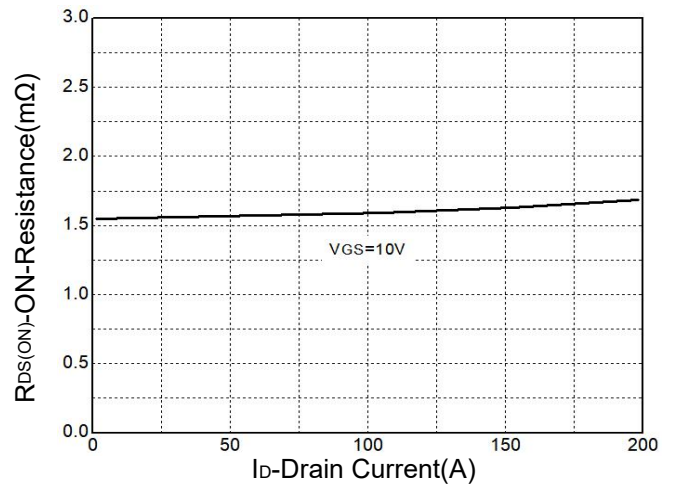

Figure 6: Drain-Source On Resistance



Typical Operating Characteristics(Cont.)

Figure 7: On-Resistance vs. Temperature

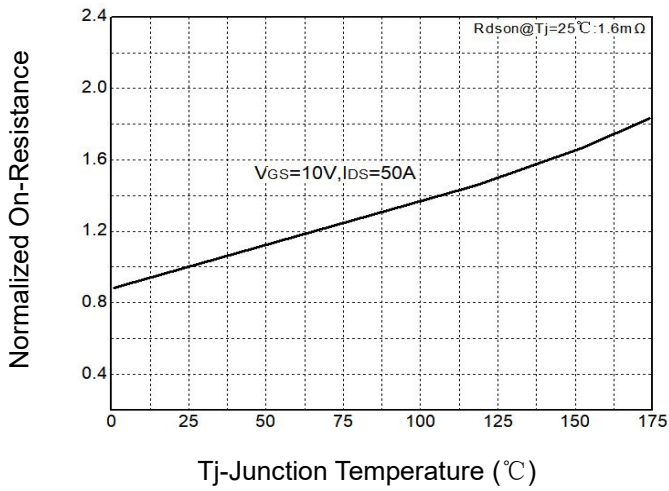

Figure 8: Source-Drain Diode Forward

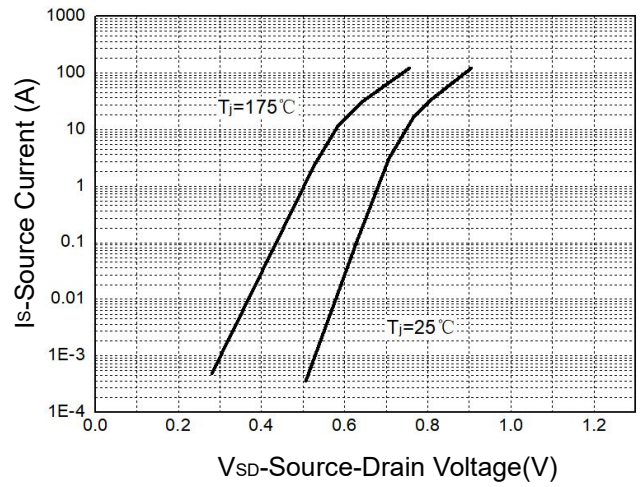

Figure 9: Capacitance Characteristics

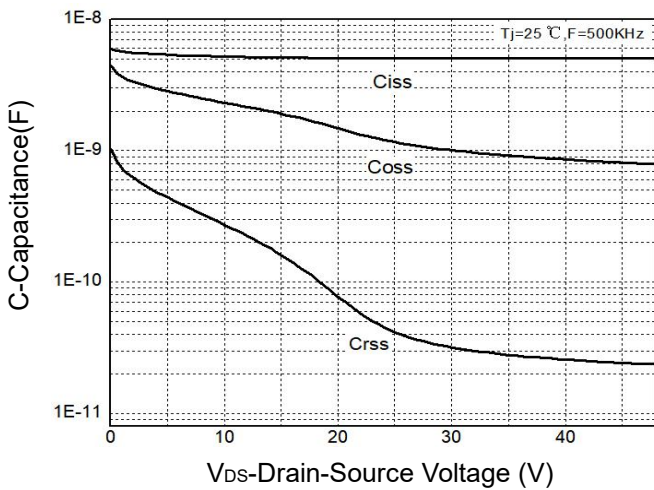
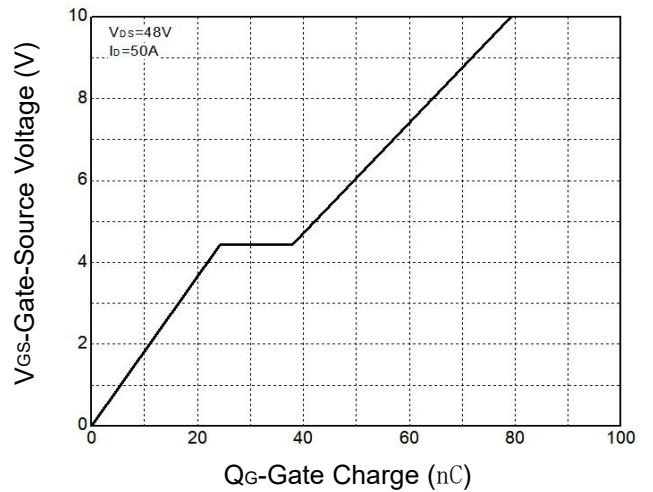
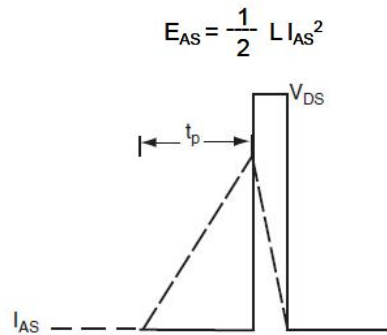
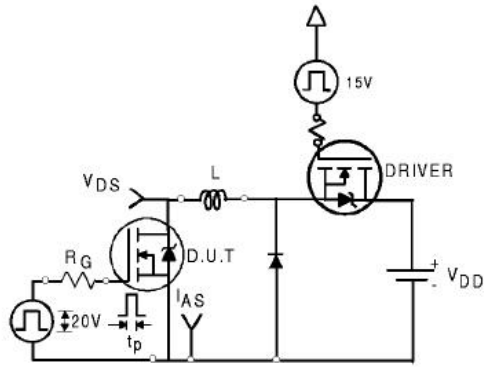

Figure 10: Gate Charge Characteristics



Avalanche Test Circuit and Waveforms



Switching Time Test Circuit and Waveforms

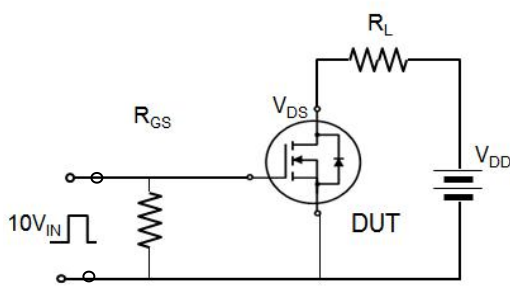

Gate Charge Test Circuit and Waveforms

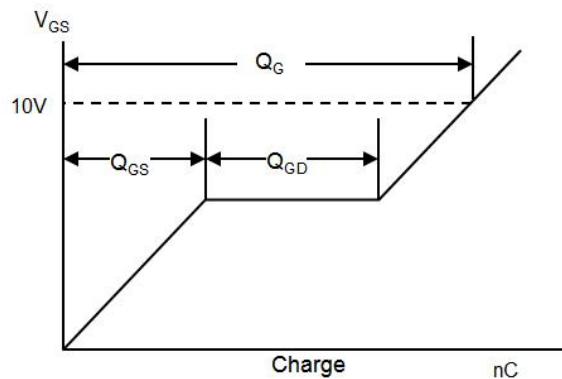
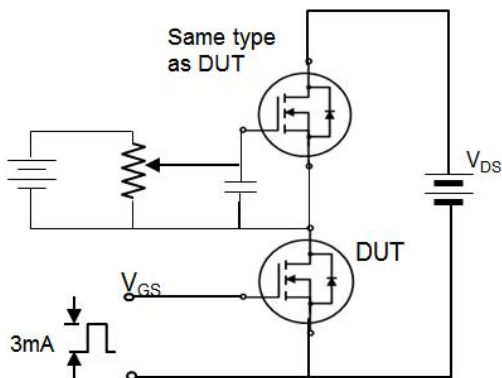

Device Per Unit

| Package Type | Unit | Quantity |
|--------------|------|----------|
| PDFN8L (5x6) | Reel | 5000 |

Package Information

PDFN8L (5x6)

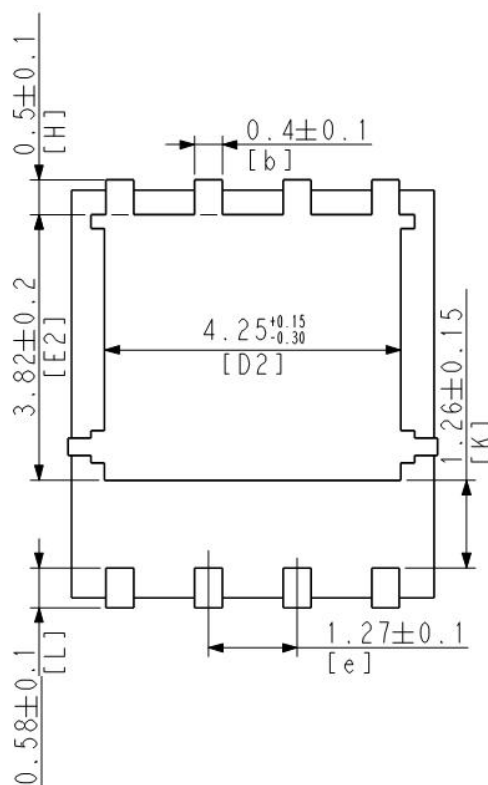
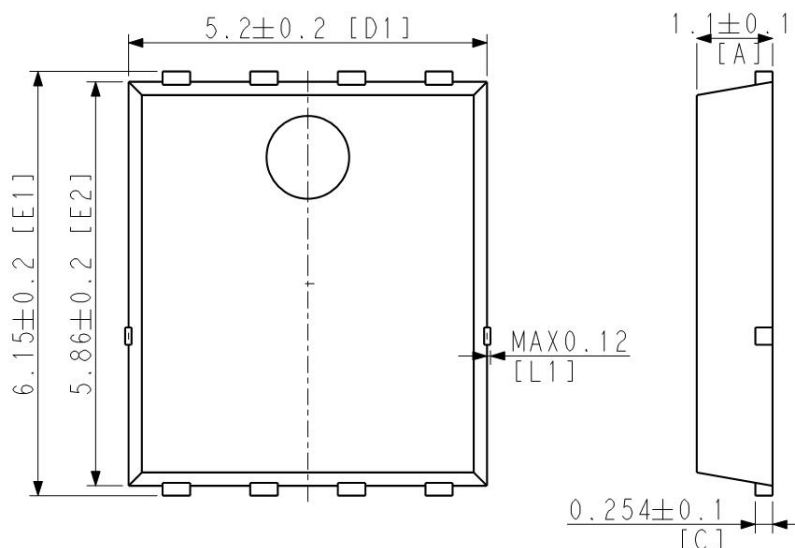

Classification Profile

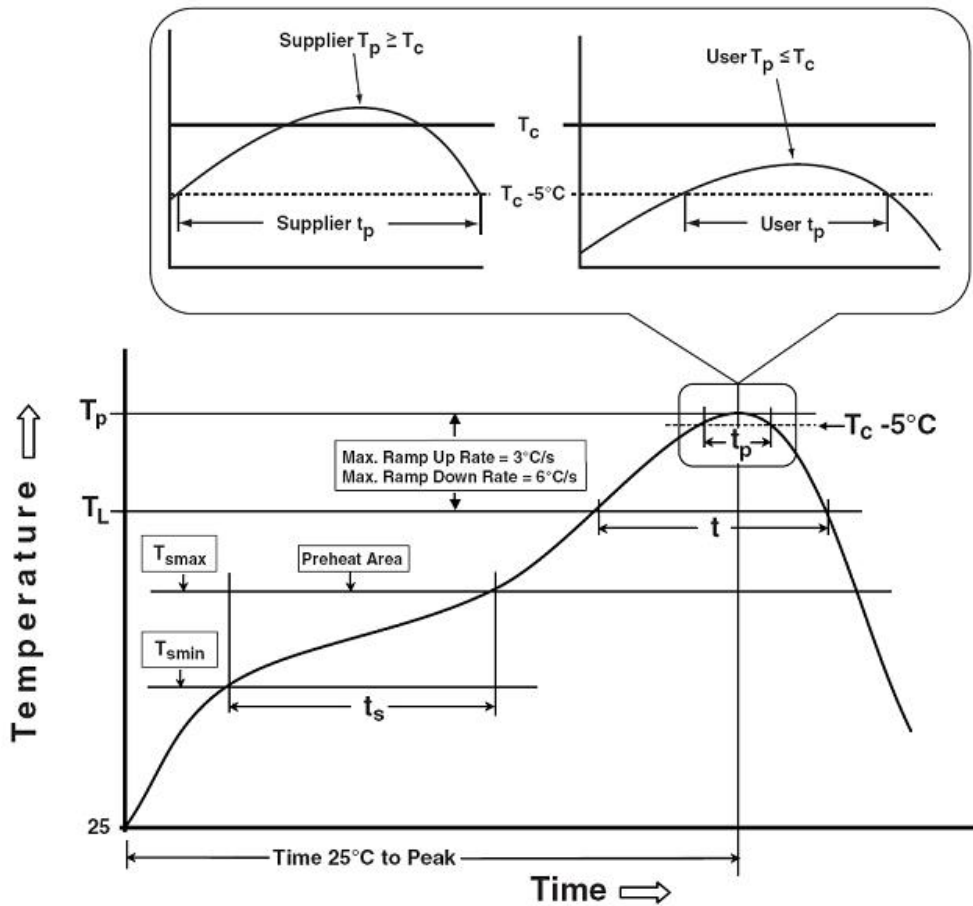

Classification Reflow Profiles

| Profile Feature | Sn-Pb Eutectic Assembly | Pb-Free Assembly |
|---|------------------------------------|------------------------------------|
| Preheat & Soak | | |
| Temperature min (T_{smin}) | 100 °C | 150 °C |
| Temperature max (T_{smax}) | 150 °C | 200 °C |
| Time (T_{smin} to T_{smax}) (t_s) | 60-120 seconds | 60-120 seconds |
| Average ramp-up rate (T_{smax} to T_p) | 3 °C/second max. | 3°C/second max. |
| Liquidous temperature (T_L) | 183 °C | 217 °C |
| Time at liquidous (t_L) | 60-150 seconds | 60-150 seconds |
| Peak package body Temperature (T_p)* | See Classification Temp in table 1 | See Classification Temp in table 2 |
| Time (t_p)** within 5°C of the specified classification temperature (T_c) | 20** seconds | 30** seconds |
| Average ramp-down rate (T_p to T_{smax}) | 6 °C/second max. | 6 °C/second max. |
| Time 25°C to peak temperature | 6 minutes max. | 8 minutes max. |

*Tolerance for peak profile Temperature (T_p) is defined as a supplier minimum and a user maximum.

** Tolerance for time at peak profile temperature (t_p) is defined as a supplier minimum and a user maximum.

Table 1.SnPb Eutectic Process – Classification Temperatures (Tc)

| Package Thickness | Volume mm ³ <350 | Volume mm ³ ≥350 |
|-------------------|--------------------------------|--------------------------------|
| <2.5 mm | 235 °C | 220 °C |
| ≥2.5 mm | 220 °C | 220 °C |

Table 2.Pb-free Process – Classification Temperatures (Tc)

| Package Thickness | Volume mm ³ <350 | Volume mm ³ 350-2000 | Volume mm ³ ≥2000 |
|-------------------|--------------------------------|------------------------------------|---------------------------------|
| <1.6 mm | 260 °C | 260 °C | 260 °C |
| 1.6 mm – 2.5 mm | 260 °C | 250 °C | 245 °C |
| ≥2.5 mm | 250 °C | 245 °C | 245 °C |

Reliability Test Program

| Test item | Method | Description |
|---------------|---------------|--|
| SOLDERABILITY | JESD-22, B102 | 5 Sec, 245°C |
| PRECON | JESD-22, A113 | 30°C/60%/192Hrs |
| HTRB | JESD-22, A108 | 168Hrs//500Hrs/1000Hrs, Bias @ 150°C |
| HTGB | JESD-22, A108 | 168 Hrs/500Hrs/1000Hrs, V _{gs} 100% @ 150°C |
| PCT | JESD-22, A102 | 96 Hrs, 100%RH, 2atm, 121°C |
| TCT | JESD-22, A104 | 500 Cycles, -55°C~150°C |

Customer Service

Worldwide Sales and Service: sales@hymexa.com

Technical Support: Technology@hymexa.com

Huayi Microelectronics Co., Ltd.

No.8928,Shangji Road,Economic and Technological Development Zone,Xi'an,China

TEL: (86-029) 86685706

FAX: (86-029) 86685705

E-mail: sales@hymexa.com

Web net: www.hymexa.com