



佛山市国星光电股份有限公司  
FOSHAN NATIONSTAR OPTOELECTRONICS CO., LTD

# 产品规格书 SPECIFICATION

顾客名称 Customer		产品名称 Product	TOP LED
顾客型号 Customer Type		产品型号 Type	FC-RGBC1515-A1
顾客部品号 Customer No.		版本号 Version NO	C0 版



地址: 广东省佛山市禅城区华宝南路 18 号  
 Add: NO.18 South Huabao Rd, Foshan, Guangdong, China  
 电话 (Tel): (光电子销售: 0757-82100219)  
 传真 (Fax): (光电子销售: 0757-82100220)  
 邮编 (Zip): 528000  
<http://www.nationstar.com>

研发中心 Research & Development Center			客户 (加盖公章) Customer (Stamp)
制定 DRAW	审核 CHECK	批准 APPROVE	确认 CONFIRM
发放日期 (Release Date): 2023-06-16			

# FC-RGBC1515-A1

# TOP Light Emitting Diode

## 技术数据表 Technical Data Sheet

本产品主要作为信号指示及照明的电子元件广泛应用于各类使用表面贴装结构的电子产品中,如家用电器的开关指示灯、液晶显示屏背光源等,也广泛适用于各类室内外的装饰照明。

<p><b>特性:</b></p> <p><b>Features:</b></p>	<ul style="list-style-type: none"> <li>➤ 管芯材料: InGaN、AlGaInP Material:</li> <li>➤ 封装材料: 环氧树脂 Encapsulation: Epoxy Resin</li> <li>➤ 焊接方法: 无铅回流焊 Soldering methods: Pb-Free reflow soldering</li> <li>➤ 光强高, 功耗低, 可靠性好, 寿命长 High Luminous Intensity ,Low Power Dissipation, Good Reliability and Long Lifespan</li> <li>➤ 符合欧盟公布的 ROHS 指令要求 Complied With ROHS Directive</li> </ul>	<p>发光颜色: 红、绿、蓝 Emitting Color: Red/Greed/Blue</p>
---	---	---

### 目录

### Catalogue

外形尺寸.....	3
电性参数.....	4
可靠性试验.....	8
包装.....	9
焊接指导.....	11
使用注意事项.....	13

\* 产品规格如因工艺改进而有所改变, 恕不另行通知。  
\* The specifications of the product may be modified for improvement without notice.

# 外形尺寸

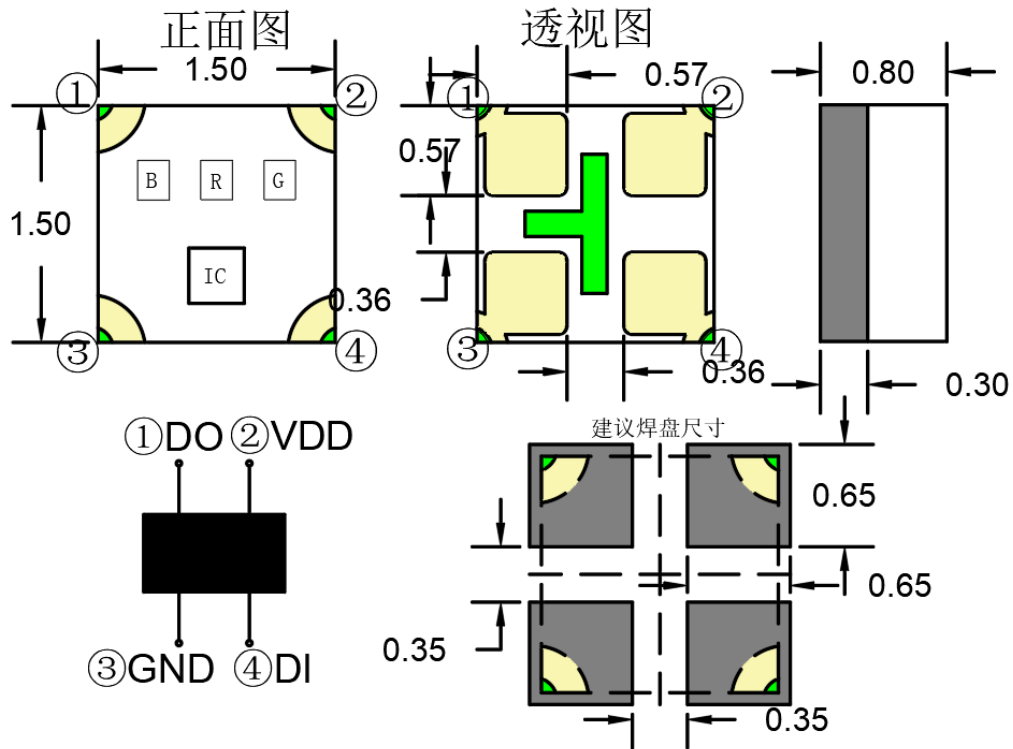

序号	管脚符号	管脚名称	功能描述
①	DO	数据输出	归零码数据级联输出
②	VDD	电源 (正)	灯珠电源正极
③	GND	地 (负)	灯珠地负极端
④	DI	数据输入	归零码数据输入

备注 Notes:

--所有尺寸为毫米标识

All dimensions are in millimeters

--未标识尺寸正负公差为 0.3mm

Tolerances unless dimensions  $\pm 0.3\text{mm}$

## 电性参数

### 1、极限参数 (温度=25℃)

参数	符号	范围	单位
逻辑电源电压	V <sub>DD</sub>	+3.0~+7.5	V
逻辑输入电压	V <sub>IN</sub>	-0.5~V <sub>DD</sub> ~+0.5	V
RGB 输出端口耐压	V <sub>OUT</sub>	9	V
工作温度范围	T <sub>opt</sub>	-25~+85	°C
储存温度范围	T <sub>stg</sub>	-40~+100	°C
静态功耗	I <sub>dd</sub>	0.5	mA
ESD 耐压	V <sub>ESD</sub>	2000	V

### 2、推荐工作条件 (温度=25℃)

参数	符号	最小值	代表值	最大值	单位
电源电压	V <sub>DD</sub>	4	5.0	5.5	V
高电平输入电压	V <sub>Ih</sub>	0.7V <sub>DD</sub>	---	V <sub>DD</sub>	V
低电平输入电压	V <sub>Il</sub>	0	---	0.3V <sub>DD</sub>	mA

### 3、光电参数 (温度=25℃)

参数	符号	光色	最小值	代表值	最大值	单位	测试条件
光强	I <sub>v</sub>	R	50	---	100	mcd	IF =5mA
		G	200	---	400		
		B	30	---	70		
主波长	λ <sub>d</sub>	R	618	---	626	nm	IF =5mA
		G	520	---	530		
		B	462	---	472		
视角	201/2	---	120	---	deg	IF =5mA	



4、电气参数 (温度=25°C)

参数	符号	最小	典型	最大	单位
芯片输入电压	V <sub>DD</sub>	-	5	7.5	V
R/G/B 输出端口耐压	V <sub>ds</sub>	-	-	9	V
R/G/B 输出驱动电流	I <sub>RGB</sub>	-	5	-	mA
高电平输入电压	V <sub>IH</sub>	0.7 V <sub>DD</sub>	-	-	V
低电平输入电压	V <sub>IL</sub>	-	-	0.3 V <sub>DD</sub>	V
PWM 频率	F <sub>PWM</sub>	-	4	-	KHZ
静态功耗	I <sub>dd</sub>	-	0.5	-	mA

5、开关特性 (温度=25°C)

参数	符号	最小	典型	最大	单位	测试条件
数据传输速率	F <sub>DIN</sub>	-	-	1100	kHz	-
传输延迟时间	T <sub>PLZ</sub>	-	-	500	ns	-

6、编码描述

芯片采用单线通讯方式,采用归零码的方式发送信号。芯片在上电复位以后,接收 DIN 端打来的数据,接收够 24 bit 后,DOUT 端口开始转发数据,为下一个芯片提供输入数据。在转发之前,DOUT 口一直拉低。此时芯片将不接收新的数据,芯片 OUTR、OUTG、OUTB 三个 PWM 输出口根据接收到的 24 bit 数据,发出相应的不同占空比的信号,该信号频率在 4 KHZ。如果 DIN 端输入信号为 RESET 信号,芯片将接收到的数据送显示,芯片将在该信号结束后重新接收新的数据,在接收完开始的 24 bit 数据后,通过 DOUT 口转发数据,芯片在没有接收到 RESET 码前,OUTR、OUTG、OUTB 管脚原输出保持不变,当接收到 80μs 以上低电平 RESET 码后,芯片将刚才接收到的 24 bit PWM 数据脉宽输出到 OUTR、OUTG、OUTB 引脚上。

7、输入码型

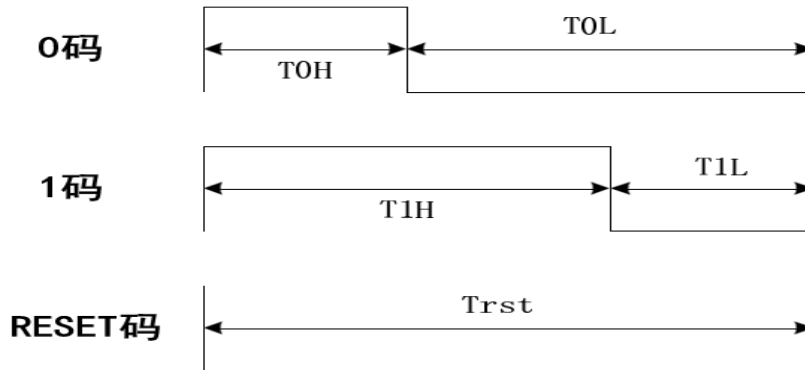

8、码型时间

名称	描述	典型值	容许误差
T0H	0 码, 高电平时间	0.3 $\mu$ s	$\pm 0.05\mu$ s
T1H	1 码, 高电平时间	0.6 $\mu$ s	$\pm 0.05\mu$ s
T0L	0 码, 低电平时间	0.6 $\mu$ s	$\pm 0.05\mu$ s
T1L	1 码, 低电平时间	0.3 $\mu$ s	$\pm 0.05\mu$ s
Trst	Reset 码, 低电平时间	$\geq 80\mu$ s	

连接方法:

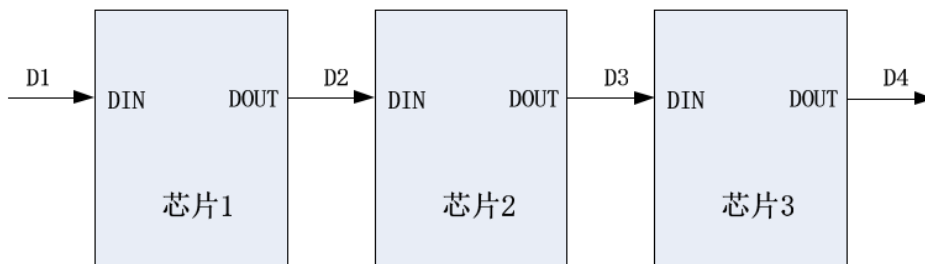

24bit 的数据结构:

G7	G6	G5	G4	G3	G2	G1	G0	R7	R6	R5	R4	R3	R2	R1	R0	B7	B6	B5	B4	B3	B2	B1	B0
----	----	----	----	----	----	----	----	----	----	----	----	----	----	----	----	----	----	----	----	----	----	----	----

注: 高位先发, 按照 GRB 的顺序发送数据

数据传输方法:

注: 其中 D1 为 MCU 端发送的数据, D2、D3、D4 为级联芯片转发的归零码数据。

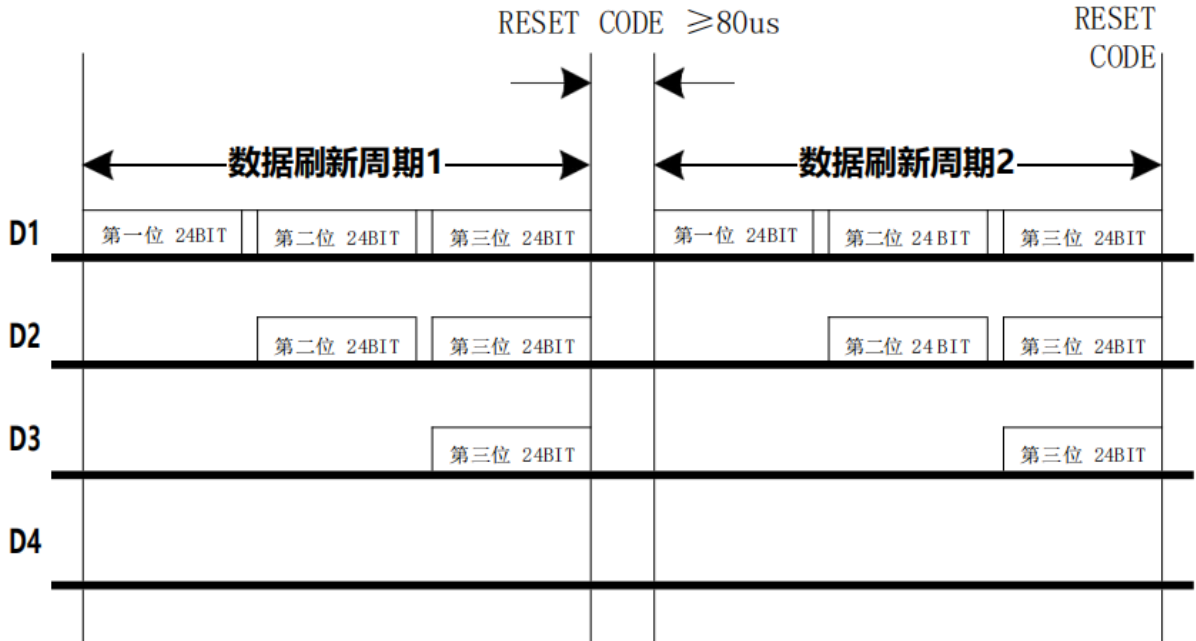

8、典型应用电路:

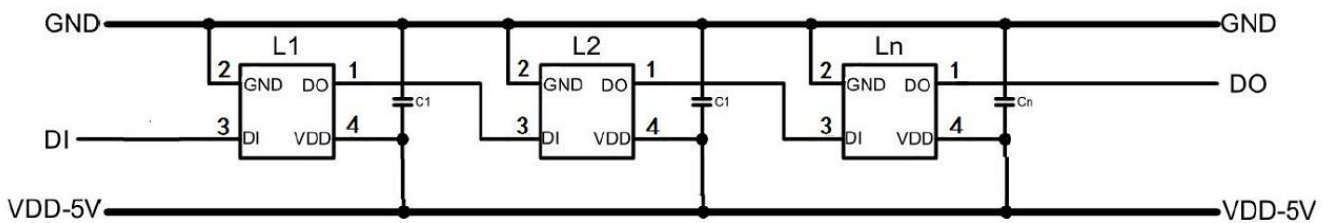

## 可靠性试验

实验项目 Test Items	参考标准 Reference	实验条件 Test Conditions	时间 Time	样品数 Quantity	判据 Criterion
冷热冲击 Thermal Shock	JESD22-A104	-40°C(30min)←→100°C(30min)	100 cycles	22	0/22
高温贮存 High Temperature Storage	JESD22-A103	Ta=100°C	1000h	22	0/22
低温贮存 Low Temperature Storage	JESD22-A119	Ta=-40°C	1000h	22	0/22
常温寿命 Lifespan Test	JESD22-A108	Ta=25°C If =5mA	1000h	22	0/22
高温高湿寿命 High Temperature High Humidity	JESD22-A101	85°C ± 5°C/85%RH IF=5mA	1000h	22	0/22
耐焊接热 Resistance to Soldering Heat	JESD22-B106	Tsol*:245°C max T=10sec	3 times	22	0/22

### 失效判断标准 Criteria For Judging Damage

测试项目	测试条件	判定标准
动态电压 (VF)	IF=5mA	>U. S. L*1.1
动态频率	IF=5mA	变色失常
焊接可靠性	/	锡膏覆盖焊盘比例小于 95%

★ U. S. L : 规格上限

★ L. S. L : 规格下限



**包装**

◇ 载带

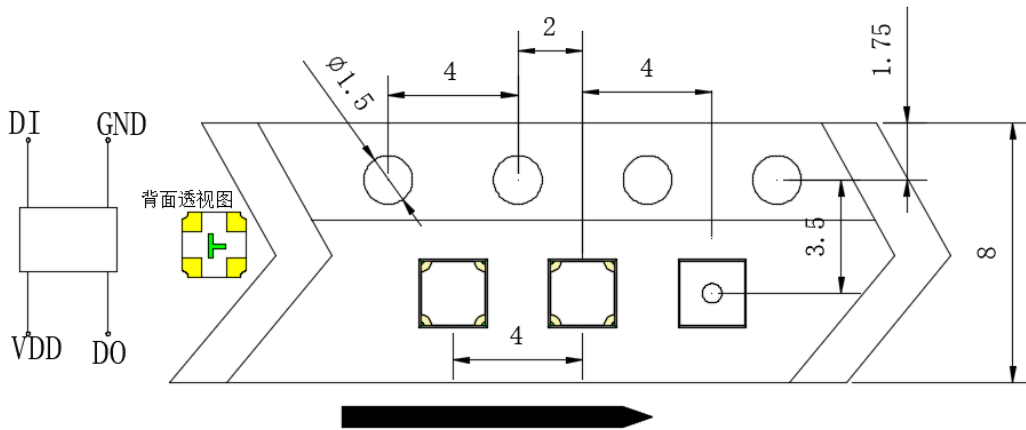

单位: mm, 未注公差:  $\pm 0.2$  mm

All dimensions in mm, tolerances unless mentioned is  $\pm 0.2$  mm

◇ 带盘

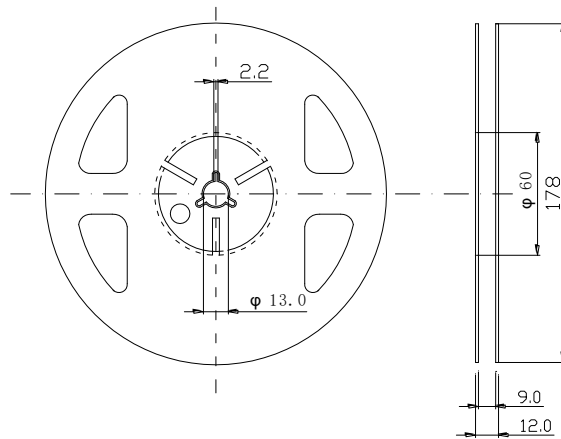

◇ 圆盘及载带卷出方向及空穴规格

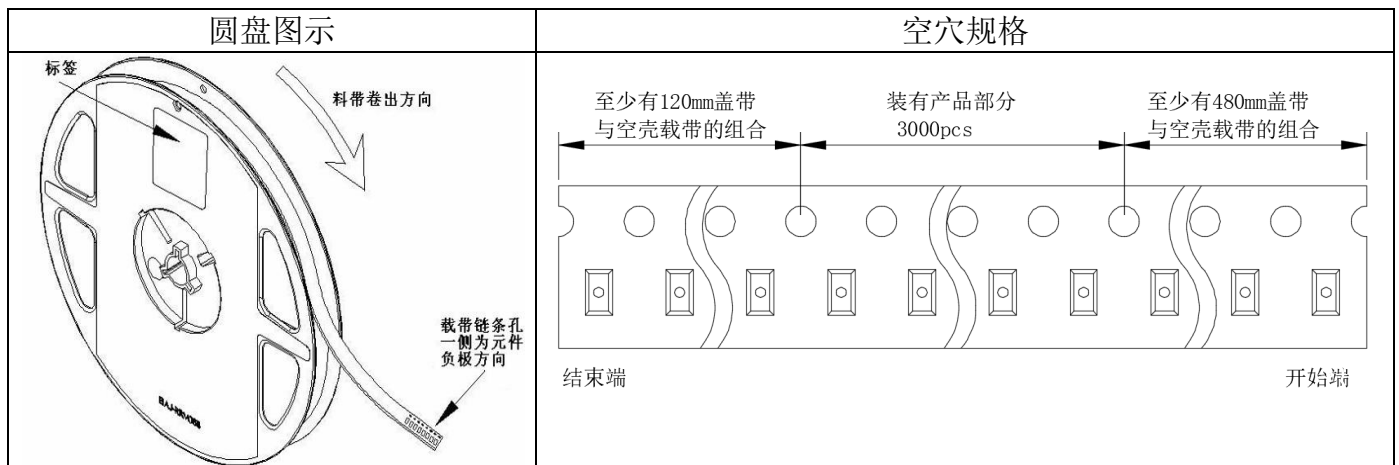

◇ 防潮防静电包装 Moisture Proof and Anti-Electrostatic Foil Bag

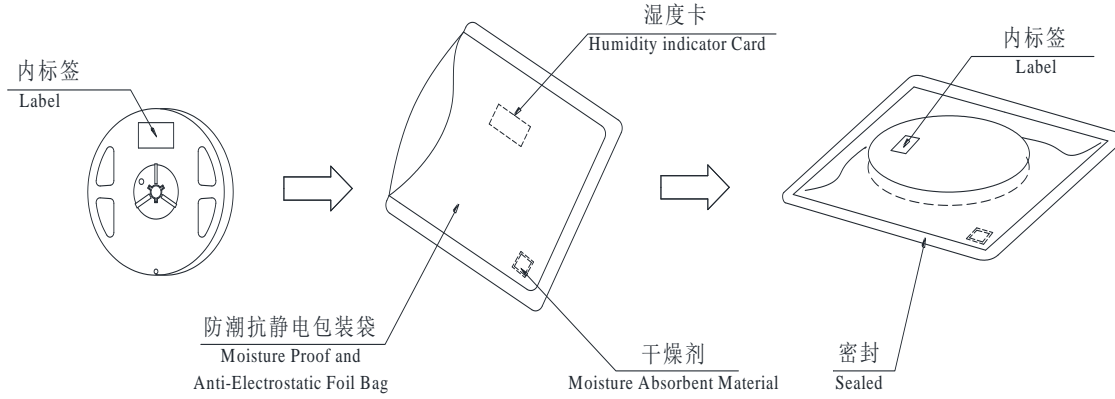

◇ 外包装箱 Cardboard Box

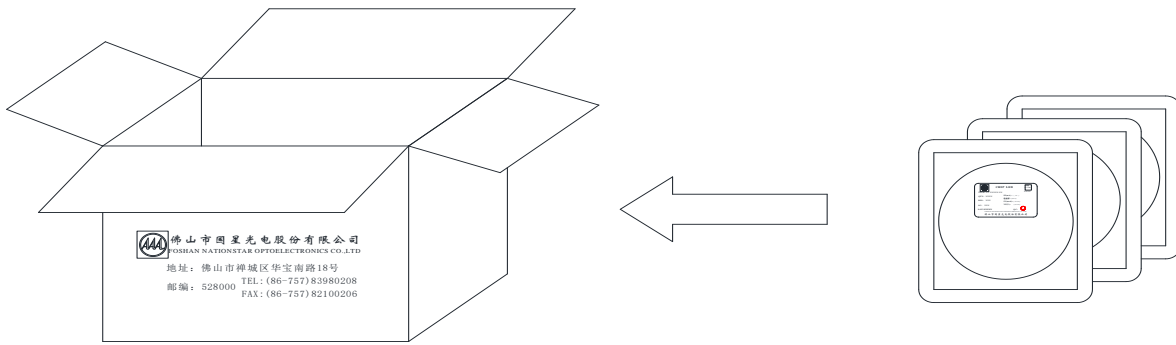

## 焊接指导

### 1. 使用烙铁人手焊接

#### Hand Soldering

建议使用防静电电烙铁, 尖端处温度不超过 350°C, 每次焊锡时少于 3 秒。电烙铁的功率宜低于 60W。每焊完一次之后间隔 2 秒以上, 分别焊好两个电极引脚。焊接时不可对透镜用力施压。LED 如有问题一般都是从焊锡时开始出现。故必须按要求小心作业。

人手焊接过程中的不慎操作易引起 LED 产品的损坏, 应当小心谨慎。

It is recommended to use anti-static electric soldering iron, the temperature at the tip does not exceed 350°C, less than 3 seconds for each soldering. The power of the soldering iron should be less than 60W. Weld two electrode pins more than 2 seconds after each welding. Do not force the lens during welding. Problems with leds usually begin when they are soldered. So you must work carefully as required.

Be careful because the damage of the product is often started at the time of the hand soldering.

### 2. 回流焊接: 推荐使用以下无铅回流焊接温度图进行。

**Reflow Soldering:** Use the conditions shown in the under Figure of Pb-Free Reflow Soldering.

#### ■ 注意事项 matters need attention:

##### 1. 回流焊只允许做一次。

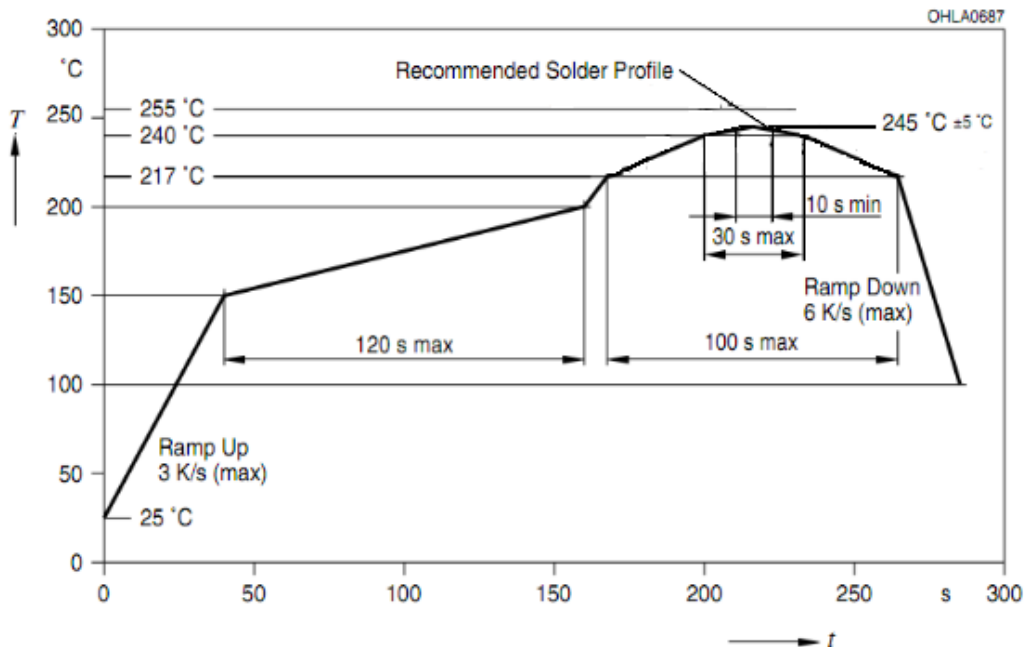

Reflow soldering is only allowed once.

##### 2. 回流焊过程中不要对灯体施加压力。

Do not apply pressure to the lamp body during reflow

##### 3. 流焊完成之后不要压挤散热板、不可压到胶体部分。

After reflow welding is completed, do not press the heat dissipation plate, do not press to the colloidal part.

4. 有比较低熔点的锡膏, TP 可以适当降低。

If there is a lower melting point of solder paste, TP can be appropriately reduced.

## 1. 清洗:

### Cleaning

在焊接后推荐使用酒精进行清洗, 在温度不高于 30°C 的条件下持续 3 分钟, 不高于 50°C 的条件下持续 30 秒。使用其他类似溶剂清洗前, 请先确认使用的溶剂不会对 LED 的封装和环氧胶部分造成损伤。

超声波清洗也是有效的方法, 一般最大功率不应超过 300W, 否则可能对 LED 造成损伤。请根据具体的情况预先测试清洗条件是否会对 LED 造成损伤。

It is recommended that alcohol be used as a solvent for cleaning after soldering. Cleaning is to go under 30°C for 3 minutes or 50°C for 30 seconds. When using other solvents, it should be confirmed beforehand whether the solvents will dissolve the package and the resin or not.

Ultrasonic cleaning is also an effective way for cleaning. But the influence of Ultrasonic cleaning on LED depends on factors such as ultrasonic power. Generally, the ultrasonic power should not be higher than 300W. Before cleaning, a pre-test should be done to confirm whether any damage to LEDs will occur.

**\* 注意:** 此一般指导原则并不适用于所有 PCB 设计和焊接设备的配置。具体工艺受到诸多因素的影响, 请根据特定的 PCB 设计和焊接设备来确定焊接方案。

**\* Note:** This general guideline may not apply to all PCB designs and configurations of all soldering equipment. The technique in practice is influenced by many factor, it should be specialized base on the PCB designs and configurations of the soldering equipment.

## 使用注意事项

### 1. 保存及使用:

#### Preservation and use

在打开包装前, LED 应存放在 30°C/60%RH 或以下的环境中。打开包装后, LED 应置于 20-30°C/30%RH 或以下的环境中使用。

Before opening the package, the LED should be stored at 30°C/60%RH or less. After opening the package, the LED should be placed in an environment of 20-30°C/30%RH or less.

Molding 封装及 SMD LED 开封后要在 24H 之内使用, 为了避免环境的影响, 建议拆封后, 经过 60°C /24H 除湿, 没用完 LED 需及时做抽真空包装处理, 避免再次使用时发生失效。

To avoid the impact of the environment, it is recommended to dehumidify after unpacking at 60°C/24H. All the leds are needed to be vacuumed to avoid failure

若干燥剂褪色或过期使用, 需干燥烘烤: 60±5°C/24 小时。

If the desiccant faded or expired use, dry baking: 60±5°C/24 hours.

LED 的胶表面易沾灰尘, 需要做好相关防尘措施。

LED Glue surface easy to dust, need to do the relevant dust prevention measures.

### 2. 静电:

#### Static Electricity

静电和电涌会导致产品特性发生改变, 例如正向电压降低等, 如果情况严重甚至会损毁产品。所以在使用时必须采取有效的防静电措施。

所有相关的设备和机器都应该正确接地, 同时必须采取其他防止静电和电涌的措施。

使用防静电手环, 防静电垫子, 防静电工作服、工作鞋、手套, 防静电容器, 都是有效的防止静电和电涌的措施。

Static electricity or surge voltage damages the LEDs. Damaged LEDs will show some unusual characteristic such as the forward voltage becomes lower, or the LEDs do not light at the low current. even not light.

All devices, equipment and machinery must be properly grounded. At the same time, it is recommended that wrist bands or anti-electrostatic gloves, anti-electrostatic containers be used when dealing with the LEDs.

### 3. 硫化:

#### Vulcanization

LED 硫化是由于环境中的硫进入支架内部与+1 价的银发生化学反应生成黑色 Ag<sub>2</sub>S 的过程。该过程会导致支架镀银层的反光能力下降, 色温漂移和光衰严重, 很大程度上影响了产品性能。因此, 在使用时应注意采取相应的防硫措施, 如避免使用挥发性强的含硫物质, 避免接触含硫较高的物质。

LED curing is due to sulfur being in bracket and the +1 price of silver in the chemical reaction generated Ag<sub>2</sub>S in the process. It will lead to the capacity of reflecting of silver layer reducing, light color temperature drift and serious decline, seriously affecting the performance of the product. So we should take corresponding measures to avioding

vulcanization, such as to avoid using sulphur volatile substances and keeping away from high sulphur content of the material.

**4. 眼睛保护忠告:**

**Safety Advice For Human Eyes**

LED 发光时, 请勿直视发光光源, 特别是对于一些光强较高的 LED, 强光可能伤害你的眼睛。

Viewing direct to the light emitting center of the LEDs, especially those of great Luminous Intensity will cause great hazard to human eyes. Please be careful.

**5. 设计建议:**

**Design Consideration**

设计电路时, 通过 LED 的电流不能超过规定的最大值, 同时, 还需使用保护电阻, 否则, 微小的电压变化将会引起较大的电流变化, 可能导致产品损毁。

建议使用以下 (A) 电路, 该电路能够很好的调节通过每个 LED 的电流; 不推荐使用 (B) 电路, 该电路在持续的电压驱动下, LED 的正向电压 ( $V_F$ ) 发生变化, 电流会随之而发生变化, 可能使某些 LED 承受高于规定的电流值。

In designing a circuit, the current through each LED must not exceed the absolute maximum rating specified for each LED. In the meanwhile, resistors for protection should be applied, otherwise slight voltage shift will cause big current change, burn out may happen.

It is recommended to use Circuit A which regulates the current flowing through each LED rather than Circuit B. When driving LEDs with a constant voltage in Circuit B, the current through the LEDs may vary due to the variation in Forward Voltage ( $V_F$ ) of the LEDs. In the worst case, some LED may be subjected to stresses in excess of the Absolute Maximum Rating.

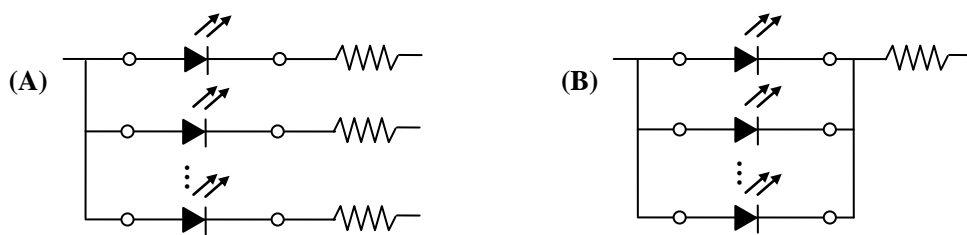

LED 的特性容易因为自身的发热和环境的温度的改变而发生改变。温度的升高会降低 LED 的发光效率、影响发光颜色等, 所以在设计时应充分考虑散热的问题。

Thermal Design is paramount importance because heat generation may result in the Characteristics decline, such as brightness decreased, Color changed and so on. Please consider the heat generation of the LEDs when making the system design.

**6. 其他事项:**

**Others**

直接用手拿取产品不但会污染封装胶表面,也可能由于静电等因素导致产品性能的改变。过度的压力也可能直接影响封装内部的管芯和金线,因此请勿对产品施加过度压力,特别当产品处于高温状态下,例如在回流焊接过程中。

When handling the product, touching the encapsulant with bare hands will not only contaminate its surface, but also affect on its optical characteristic. Excessive force to the encapsulant might result in catastrophic failure of the LEDs due to die breakage or wire deformation. For this reason, please do not put excessive stress on LEDs, especially when the LEDs are heated such as during Reflow Soldering.

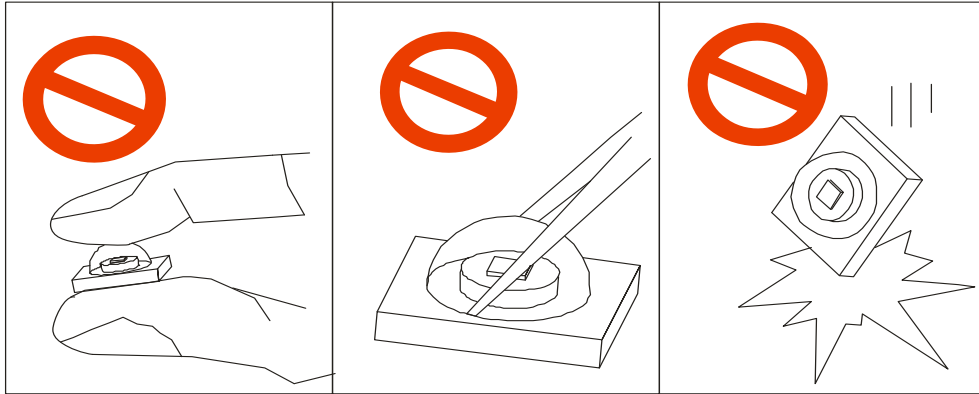

LED 的硅胶封装部分相当脆弱,请勿用坚硬、尖锐的物体刮、擦封装胶部分。在用镊子夹取的时候也应当小心注意。

The silicon resin of encapsulant is fragile, so please avoid scratch or friction over the epoxy resin surface. While handling the product with tweezers, do not hold by the epoxy resin, be careful.