

E
D
C
B
A

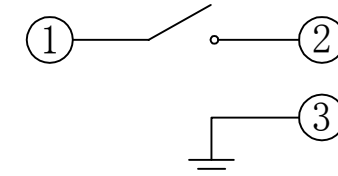

电路图
CIRCUIT DIAGRAM

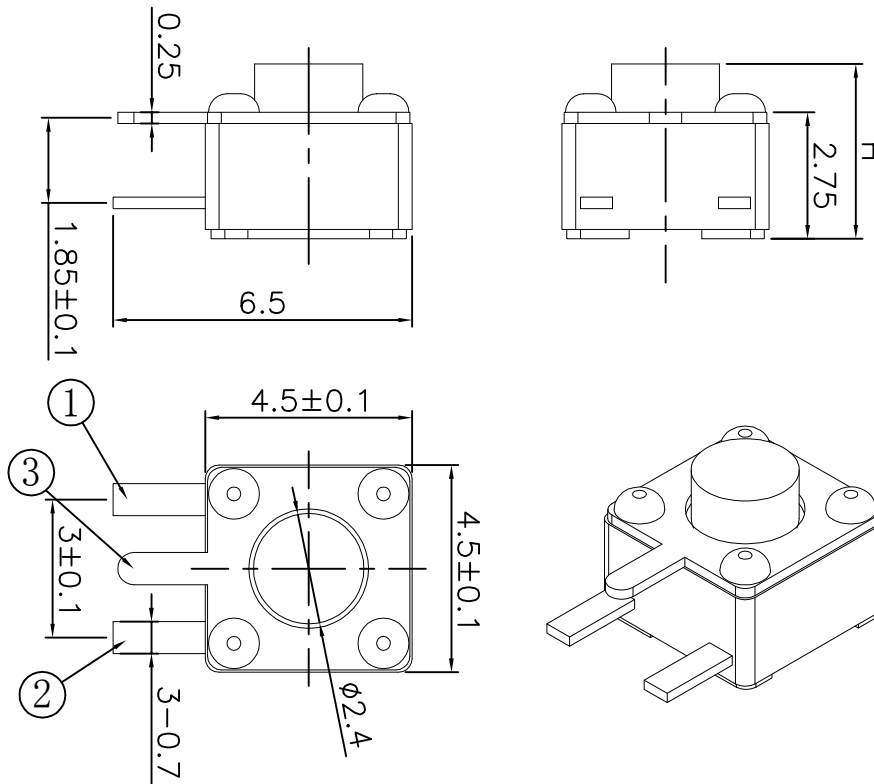
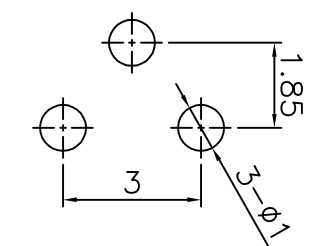

PCB. 焊接图
PCB. WELDING DRAWING

主要技术参数、性能
The Main Thchnology Performance

额定电流、电压 Rate voltage.current	50mA DC12V
接触电阻 Contact resistance	≤100mΩ
按力 Operating force	±50gf
行程 Travel	0.20±0.10mm
绝缘电阻 Insulated resistance	≥100MΩ
介电强度 Dielectric strength	≥250VAC/1min

E	按钮	PPA	1	黑色
D	盖板	铁	1	镀铜锡
C	弹片	不锈钢	1	镀银
B	本体	PPA	1	黑色
A	卡件	黄铜	1	镀银
项目 ITEM	名称 DESCRIPTION	材质 MATERIAL	数量 QTY	表面处理/颜色 FINSH/COLOR

					第一视角 FIRST VIEW		名称/NAME: 4.5*4.5*4.3边三脚	
							型号/MODEL: ZX-QC4545-4.3BSJ	
标记 SING	处数 FREQUENCY	更改文件号 REVISION	签名 APPROVED	日期 DATE	比例 SCALE	1:1	一般公差 GENERAL TOLERANCE	
设计 DESIGN			2021.06.01		单位 UNIT	mm	≥0~2<	±0.10
审核 CHECKED			2021.06.01		重量 WEIGHT		≥2~5<	±0.25
批准 APPROVED			2021.06.01				≥5	±0.30
							角度 ANGLE	±0.5°

名称/NAME:
4.5*4.5*4.3边三脚

型号/MODEL:
ZX-QC4545-4.3BSJ

兆星精密电子 (深圳) 有限公司