



TAI-SAW TECHNOLOGY CO., LTD.

No. 3, Industrial 2nd Rd., Ping-Chen Industrial District,
Taoyuan, 324, Taiwan, R.O.C.

TEL: 886-3-4690038 FAX: 886-3-4697532

E-mail: tstsales@mail.taisaw.com Web: www.taisaw.com

Approval Sheet For Product Specification

Issued Date: 8/1/2007 (REV. NO: 1)

Product Name: SMD 2.5x2.0 26.0MHz Crystal Unit

TST Parts No.: TZ0711B

Customer Parts No. : _____

Company: _____
Division: _____
Approved by: _____
Date: _____

Checked by: _____ Kelly Huang

Approval by: _____ Robert Chang

Date: _____ 8/1/2007



TAI-SAW TECHNOLOGY CO., LTD.

No. 3, Industrial 2nd Rd., Ping-Chen Industrial District,
Taoyuan, 324, Taiwan, R.O.C.

TEL: 886-3-4690038 FAX: 886-3-4697532

E-mail: tstsales@mail.taisaw.com Web: www.taisaw.com

SMD 2.5x2.0 26.0MHz Crystal Unit

MODEL NO.: TZ0711B

REV. NO.: 1

Features:

- Surface Mount Seam Weld Package
- Excellent Reliability Performance
- Ultra Miniature Package

RoHS Compliant
Lead free
Lead-free soldering

Description and Applications:

Surface mount 2.5mmx2.0mm crystal unit for use in communications devices, especially for a need of ultra miniature package for mobility.

Electrical Specifications:

TZ0711B	Specification
Nominal Frequency	26.000000 MHz
Mode of Oscillation	Fundamental
Storage Temperature Range	-40°C to +85°C
Operating Temperature Range	-20°C to +70°C
Frequency Stability over Operating Temperature Range	+/-10 ppm (referred to the value at 25°C)
Frequency Make Tolerance (FL)	+/-10 ppm @ 25°C +/- 3°C
Equivalent Series Resistance (ESR)	100 Ω max
Nominal Drive Level	10 uW
Shunt Capacitance (Co)	3 pF max
Load Capacitance (CL)	12 pF
Marking	Laser Marking

Mechanical Dimensions (mm):

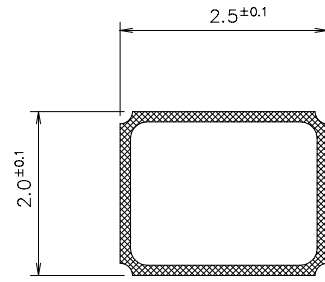

	Pin Connection
#1 pin	IN/OUT
#2 pin	GND
#3 pin	IN/OUT
#4 pin	GND

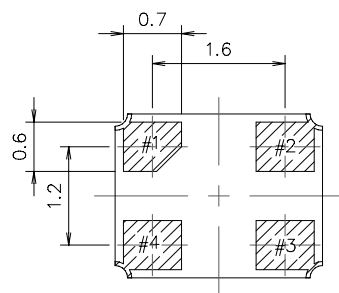
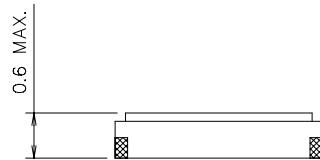

Internal Connections
(Top View)

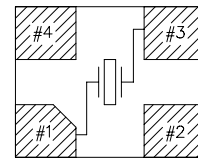

[NOTE] #2, #4 is connected with a cover
(Please connect with a GND ora power supply)

Recommended Land Pattern: (unit: mm)

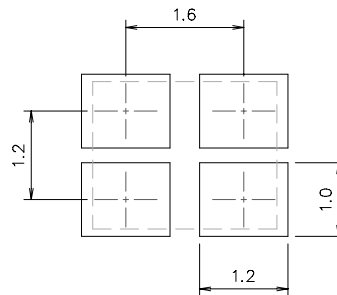

Marking:

Line 1: Frequency (26.0)

Line 2: TST Logo + Date Code + Product Code

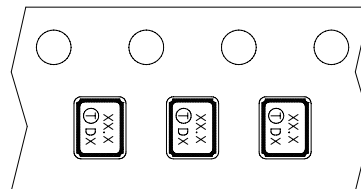
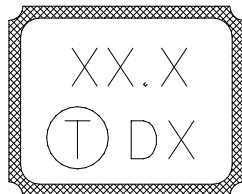

Date Code Table

WK01	WK02	WK03	WK04	WK05	WK06	WK07	WK08	WK09	WK10	WK11	WK12	WK13
A	B	C	D	E	F	G	H	I	J	K	L	M
WK14	WK15	WK16	WK17	WK18	WK19	WK20	WK21	WK22	WK23	WK24	WK25	WK26
N	O	P	Q	R	S	T	U	V	W	X	Y	Z
WK27	WK28	WK29	WK30	WK31	WK32	WK33	WK34	WK35	WK36	WK37	WK38	WK39
a	b	c	d	e	f	g	h	i	j	k	l	m
WK40	WK41	WK42	WK43	WK44	WK45	WK46	WK47	WK48	WK49	WK50	WK51	WK52
n	o	p	q	r	s	t	u	v	w	x	y	z

Product Code Table

Year	2001 2005	2002 2006	2003 2007	2004 2008
Product Code	X	x	<u>X</u>	<u>x</u>

Reel Dimensions (mm):

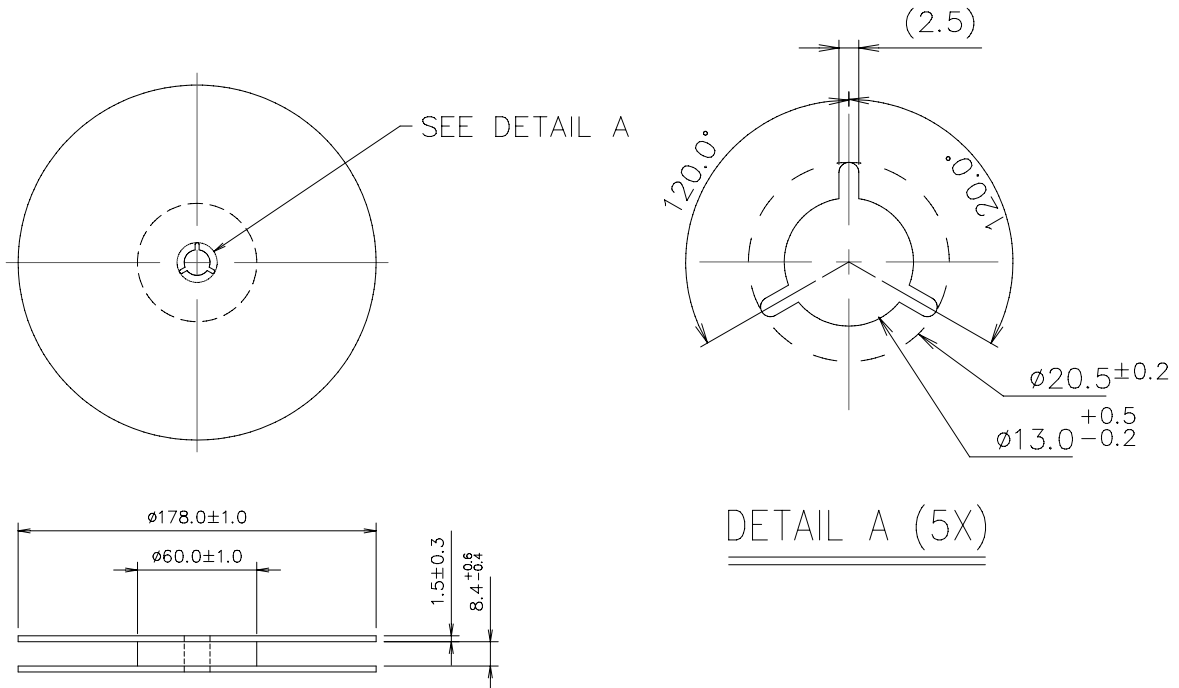

Tape Dimensions (mm):

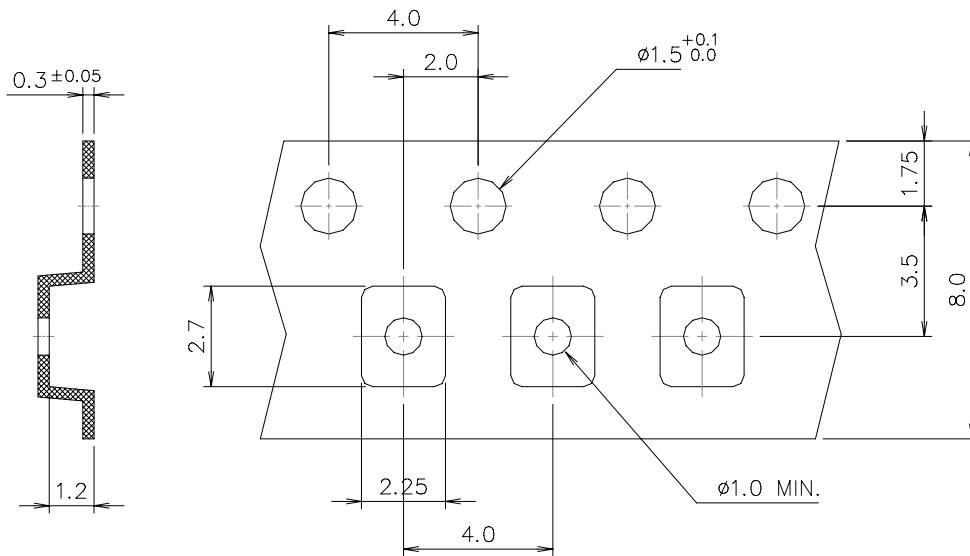

[NOTE]:

1. Unless otherwise specified tolerance on dimension +/-0.1 mm.
2. Material: conductive polystyrene with color black.
3. 10 pitch cumulative tolerance +/-0.2 mm.

Reflow Profile:

