

KN3M65017D

SiC Power MOSFET

V_{DS}	=	1700 V
$R_{DS(on)}$	=	650 m Ω
$I_D@25^\circ C$	=	7.0 A

Features

- High Blocking Voltage with Low On-Resistance
- High Speed Switching with Low Capacitance
- Easy to Parallel and Simple to Drive
- Ultra-low Drain-gate capacitance

Benefits

- Higher System Efficiency
- Reduced Cooling Requirements
- Increased System Reliability
- Increased System Switching Frequency

Applications

- Auxiliary Power Supplies
- Switch Mode Power Supplies
- High-voltage Capacitive

Package

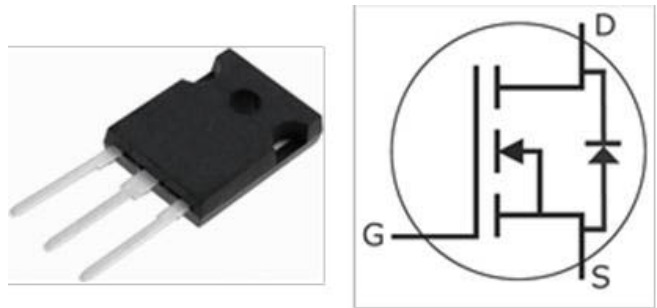

Part Number	Package
KNF3M65017D	TO-247-3

Maximum Ratings ($T_c=25^\circ C$ unless otherwise specified)

Symbol	Parameter	Value	Unit	Test Conditions	Note
V_{DSmax}	Drain-Source Voltage	1700	V	$V_{GS}=0V, I_D=100\mu A$	
V_{GSmax}	Gate-Source Voltage	-10/+25	V	Absolute maximum values	
V_{GSop}	Gate-Source Voltage	-5/+20	V	Recommended operational values	
I_D	Continuous Drain Current	7.0	A	$V_{GS}=20V, T_c=25^\circ C$	
		4.5		$V_{GS}=20V, T_c=100^\circ C$	
$I_{D(pulse)}$	Pulsed Drain Current	9.0	A	Pulse width t_p limited by T_{Jmax}	
P_D	Power Dissipation	62	W	$T_c=25^\circ C, T_J=150^\circ C$	
T_J, T_{STG}	Operating Junction and Storage Temperature	-55 to +150	$^\circ C$		

Electrical Characteristics (T_c=25°C unless otherwise specified)

Symbol	Parameter	Min.	Typ.	Max.	Unit	Test Conditions	Note
V _{(BR)DSS}	Drain-Source Breakdown Voltage	1700	/	/	V	V _{GS} =0V, I _D =100μA	
V _{GS(th)}	Gate Threshold Voltage	2.0	2.6	4.0	V	V _{DS} =V _{GS} , I _D =1.0mA	Fig. 11
		/	1.8	/		V _{DS} =V _{GS} , I _D =1.0mA, T _J =150°C	
I _{DSS}	Zero Gate Voltage Drain Current	/	1	100	μA	V _{DS} =1700V, V _{GS} =0V	
I _{GSS+}	Gate-Source Leakage Current	/	10	250	nA	V _{DS} =0V, V _{GS} =25V	
I _{GSS-}	Gate-Source Leakage Current	/	10	250	nA	V _{DS} =0V, V _{GS} =-10V	
R _{DS(on)}	Drain-Source On-State Resistance	/	650	850	mΩ	V _{GS} =20V, I _D =2.0A	
		/	1300	/		V _{GS} =20V, I _D =2.0A, T _J =150°C	
g _{fs}	Transconductance	/	1.06	/	S	V _{DS} =20V, I _D =2.0A	Fig. 4,5,6
		/	1.14	/		V _{DS} =20V, I _D =2.0A, T _J =150°C	
C _{iss}	Input Capacitance	/	194	/	pF	V _{GS} =0V	Fig. 15,16
C _{oss}	Output Capacitance	/	13	/		V _{DS} =1000V	
C _{rss}	Reverse Transfer Capacitance	/	1.8	/		f=1MHz	
E _{oss}	C _{oss} Stored Energy	/	6.6	/	μJ	V _{AC} =25mV	
E _{ON}	Turn-On Switching Energy	/	5	/	mJ	V _{DS} =1200V, V _{GS} =-5V/20V	
E _{OFF}	Turn-Off Switching Energy	/	9.2	/		I _D =2.0A, R _{G(ext)} =2.5Ω, L=100μH	
t _{d(on)}	Turn-On Delay Time	/	13.8	/	ns	V _{DS} =1200V, V _{GS} =-5V/20V, I _D =2.0A R _{G(ext)} =2.5Ω, R _L =20Ω	
t _r	Rise Time	/	22.8	/			
t _{d(off)}	Turn-Off Delay Time	/	38	/			
t _f	Fall Time	/	14	/			
R _{G(int)}	Internal Gate Resistance	/	18	/	Ω	f=1MHz, V _{AC} =25mV	
Q _{GS}	Gate to Source Charge	/	5.4	/	nC	V _{DS} =1200V	
Q _{GD}	Gate to Drain Charge	/	7.6	/		V _{GS} =-5V/20V	
Q _G	Total Gate Charge	/	23	/		I _D =2.0A	

Reverse Diode Characteristics

Symbol	Parameter	Typ.	Max.	Unit	Test Conditions	Note
V _{SD}	Diode Forward Voltage	4.2	/	V	V _{GS} =-5V, I _{SD} =25A	Fig. 8,9,10
		3.9	/		V _{GS} =-5V, I _{SD} =25A, T _J =150°C	
I _S	Continuous Diode Forward Current	/	7.0	A	T _C =25°C	
t _{rr}	Reverse Recover Time	25	/	ns	V _R =1200V, I _{SD} =2.0A	
Q _{rr}	Reverse Recovery Charge	15	/	nC		
I _{rrm}	Peak Reverse Recovery Current	2.8	/	A		

Thermal Characteristics

Symbol	Parameter	Typ.	Max.	Unit	Test Conditions	Note
R _{θJC}	Thermal Resistance from Junction to Case	1.8	/	°C/W		
R _{θJA}	Thermal Resistance from Junction to Ambient	/	40			

Typical Performance

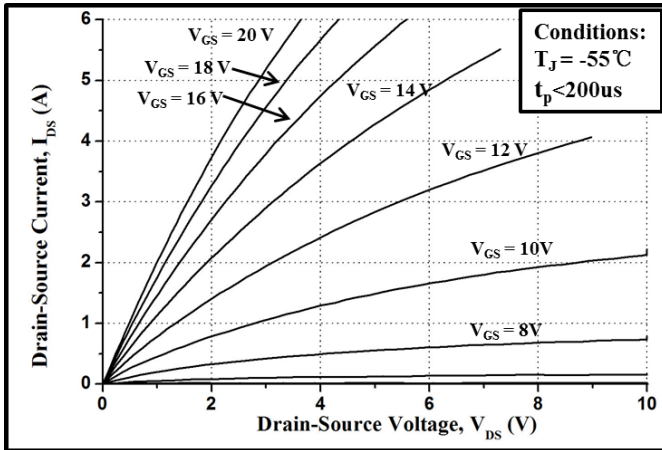

Figure 1. Output Characteristics $T_J = -55\text{ }^\circ\text{C}$

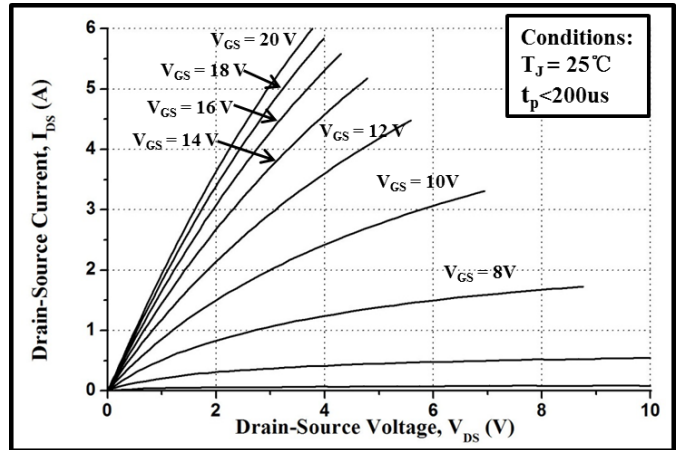

Figure 2. Output Characteristics $T_J = 25\text{ }^\circ\text{C}$

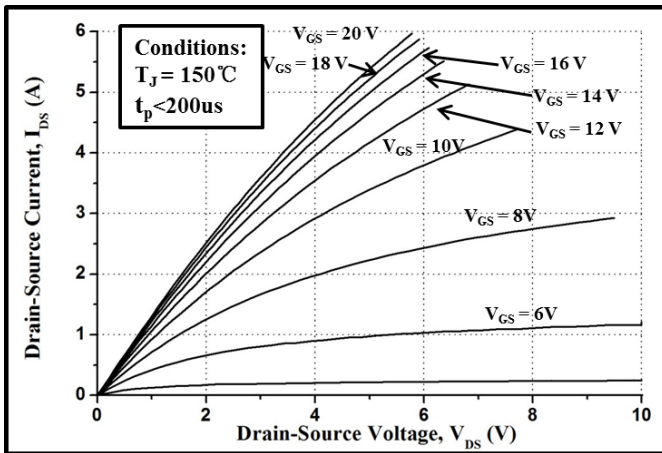

Figure 3. Output Characteristics $T_J = 150\text{ }^\circ\text{C}$

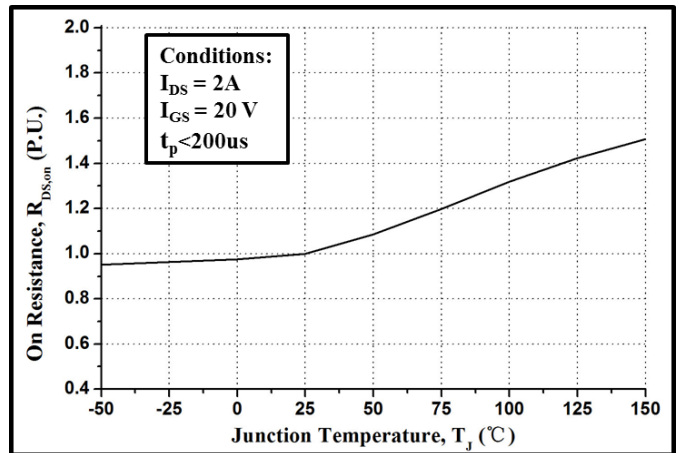

Figure 4. Normalized On-Resistance vs. Temperature

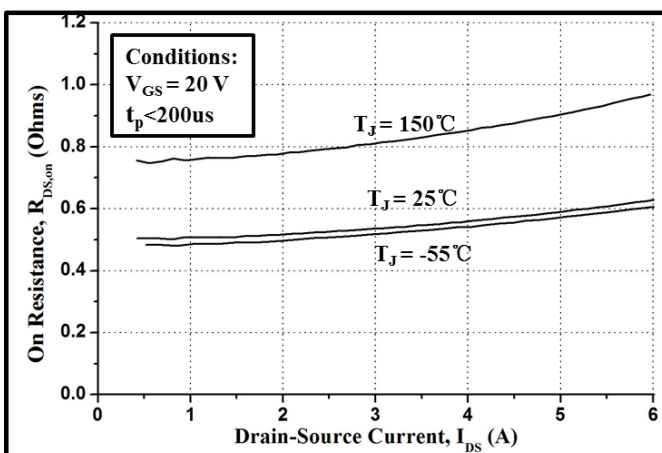

Figure 5. On-Resistance vs. Drain Current
For Various Temperatures

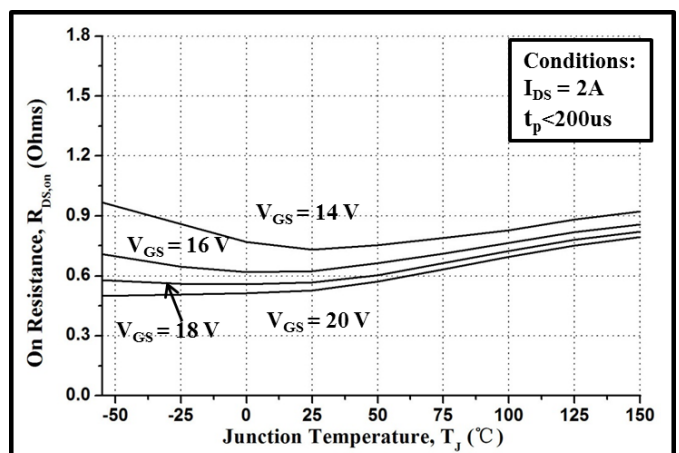

Figure 6. On-Resistance vs. Temperature
For Various Gate Voltage

Typical Performance

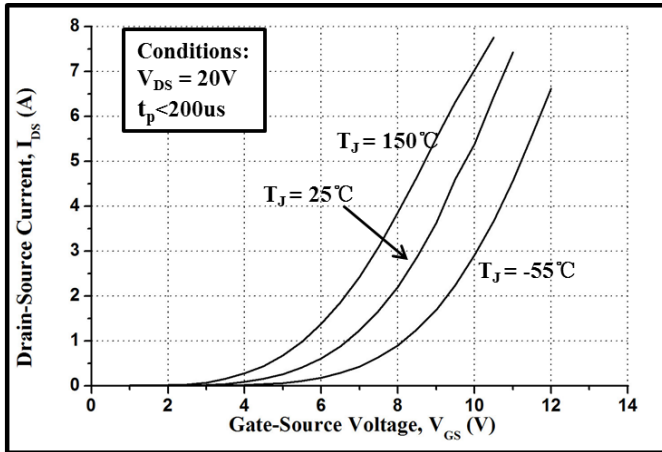

Figure 7. Transfer Characteristic for Various Junction Temperatures

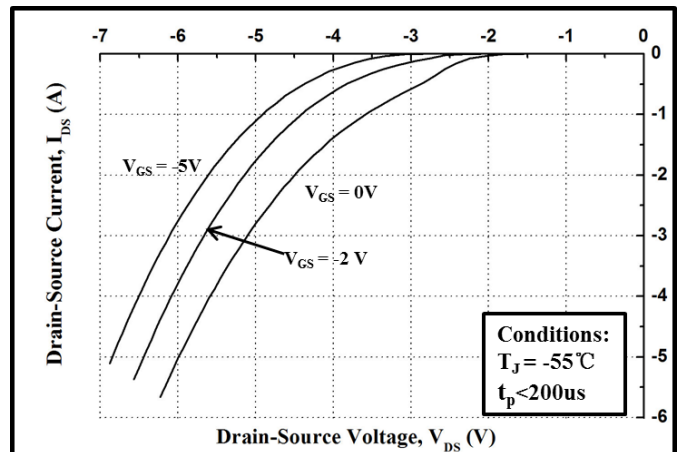

Figure 8. Body Diode Characteristic at -55 °C

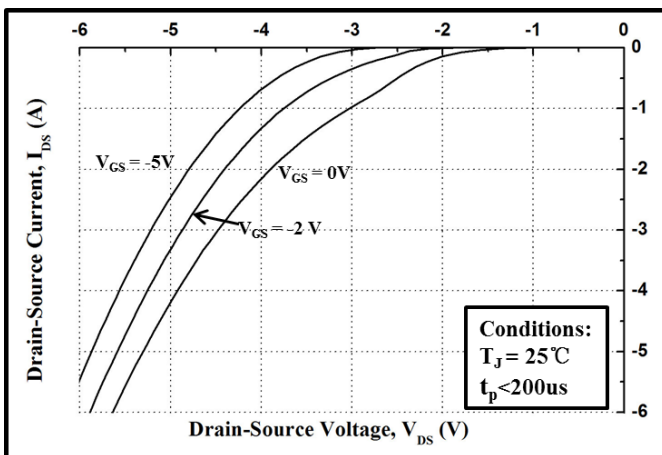

Figure 9. Body Diode Characteristic at 25 °C

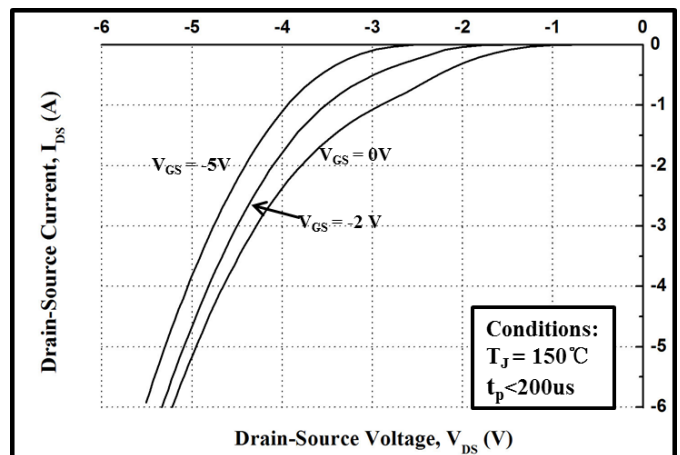

Figure 10. Body Diode Characteristic at 150 °C

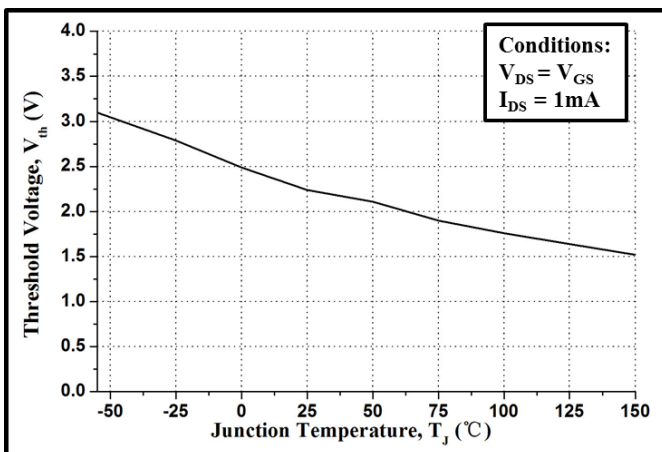

Figure 11. Threshold Voltage vs. Temperature

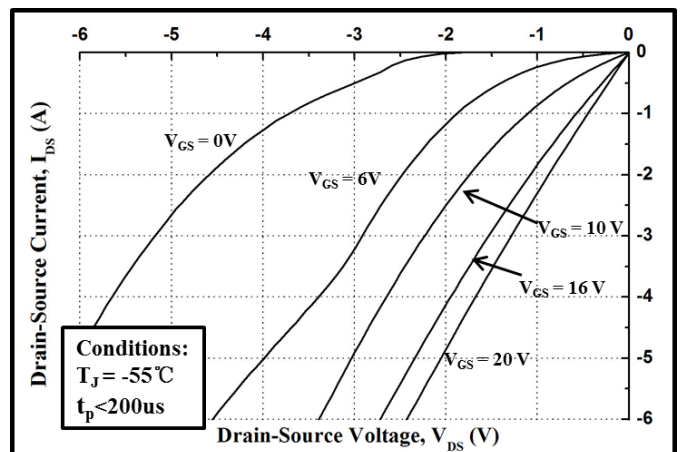

Figure 12. 3rd Quadrant Characteristic at -55 °C

Typical Performance

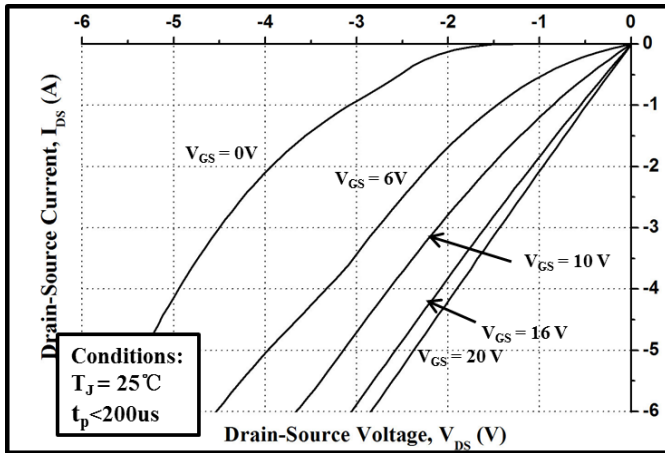

Figure 13. 3rd Quadrant Characteristic at 25 °C

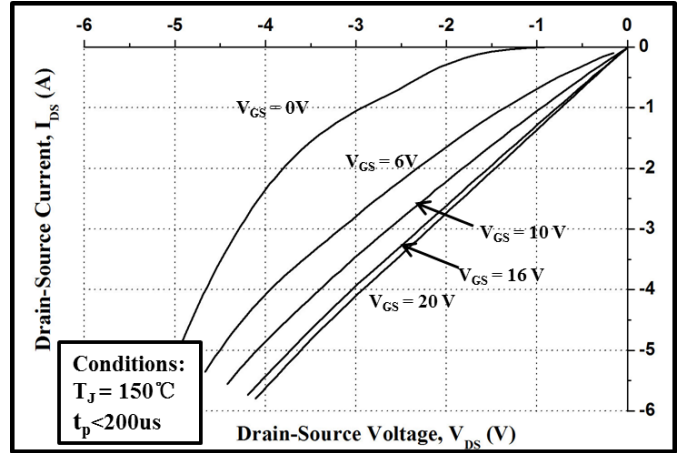

Figure 14. 3rd Quadrant Characteristic at 150 °C

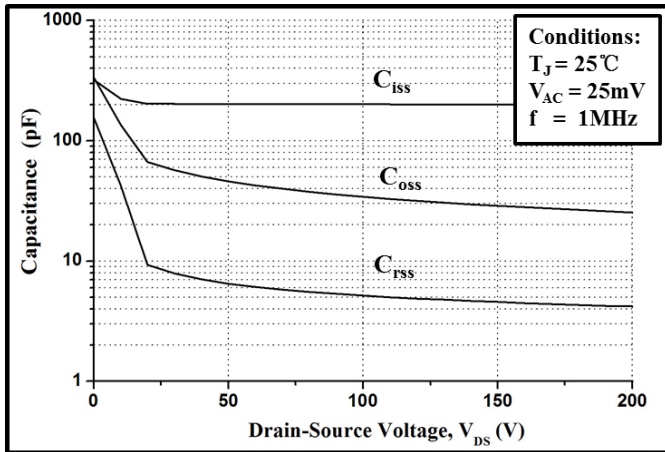

Figure 15. Capacitances vs. Drain-Source Voltage (0 - 200V)

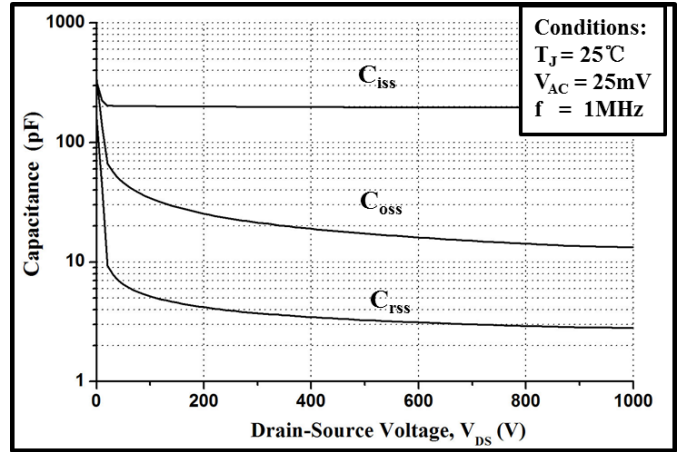

Figure 16. Capacitances vs. Drain-Source Voltage (0 - 1000V)

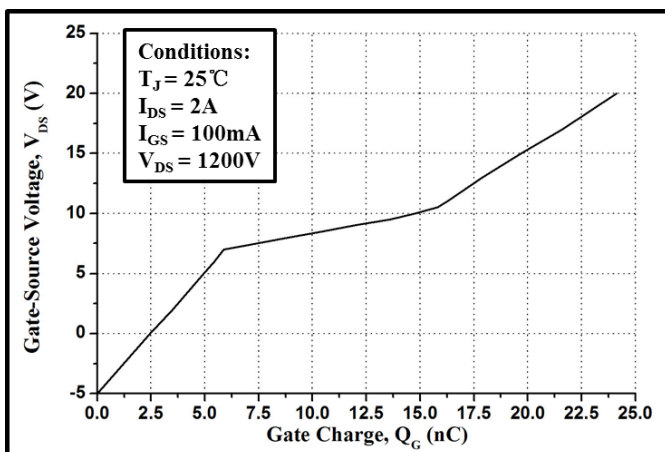

Figure 17. Gate Charge Characteristic

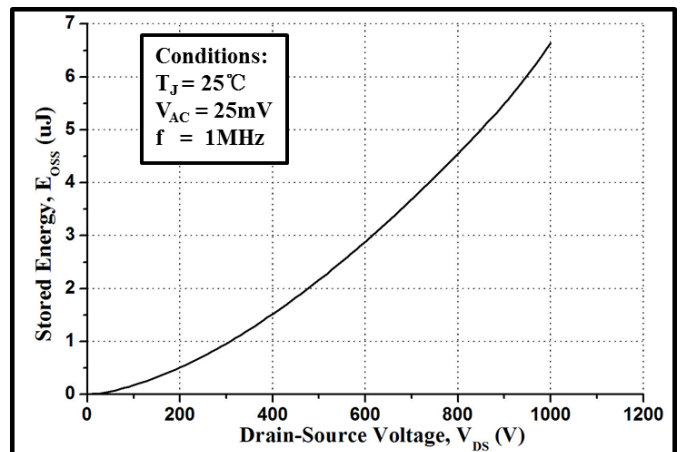
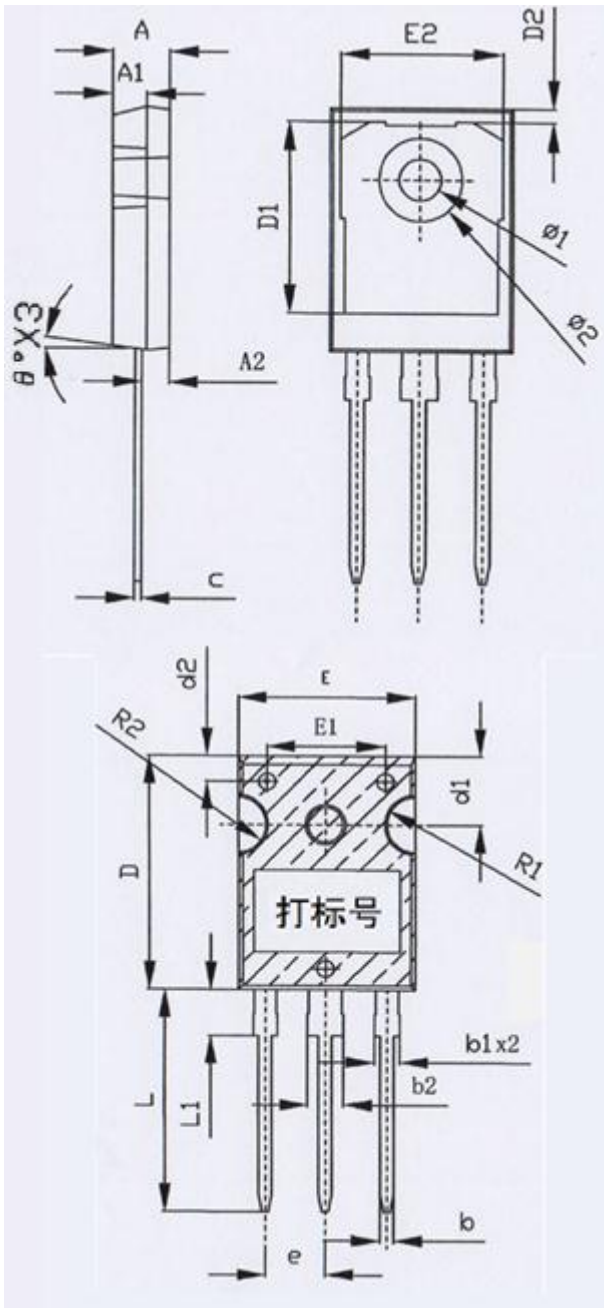

Figure 18. Output Capacitor Stored Energy

Package Dimensions

Package TO-247-3



SYMBOLS	DIMENSIONS IN MILLIMETERS		
	MIN	NOM	MAX
A	4.9	5	5.1
A1	2.9	3	3.1
A2	2.31	2.36	2.41
b	1.16	1.2	1.26
b1	2.05	-	2.2
b2	3.05	-	3.2
c	0.58	0.6	0.66
D	20.9	21	21.1
D1	16.46	16.56	16.76
D2		1.17	
d1	6.05	6.15	6.25
d2	2.2	2.3	2.4
E	15.7	15.8	15.9
E1		10.5	
E2		14.02	
e	-	1.27bcs	-
L	19.82	19.92	20.02
L1	1.88	1.98	2.08
θ	0°	7°	8°
R1	-	2.7	-
R2	-	2.5	-
$\Phi 1$		3.6	
$\Phi 2$	-	7.19	-