



## SMCG Plastic-Encapsulate Diodes

### CJSMCJ SERIES Transient Voltage Suppressor Diodes

#### Features

- $P_{PP}$  1500W
- $V_{RWM}$  10V- 100V
- Glass passivated chip

#### Applications

- Clamping Voltage

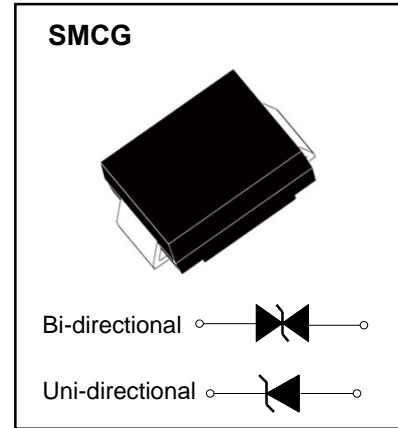

#### Limiting Values (Absolute Maximum Rating)

Item	Symbol	Unit	Conditions	Max
Peak pulse power dissipation	$P_{PPM}$	W	with a 10/1000us waveform	1500
Peak pulse current(note1)	$I_{PPM}$	A	with a 10/1000us waveform	See Next Table
Power dissipation	$P_D$	W	On infinite heat sink at $T_L=50^\circ\text{C}$	6.5
Peak forward surge current	$I_{FSM}$	A	8.3 ms single half sine-wave uni-directional only (note 2)	200
Operating junction and storage temperature range	$T_J, T_{STG}$	$^\circ\text{C}$		-55 to +150

#### Electrical Characteristics ( $T_A=25^\circ\text{C}$ Unless otherwise specified)

Item	Symbol	Unit	Conditions	Max
Maximum instantaneous forward Voltage	$V_F$	V	at 100A for uni-directional only	3.5
Thermal resistance	$R_{\theta JL}$	$^\circ\text{C}/\text{W}$	junction to lead $T_L=50^\circ\text{C}$	15
	$R_{\theta JA}$	$^\circ\text{C}/\text{W}$	junction to ambient $T_A=25^\circ\text{C}$	75

#### Notes:

- (1) Non-repetitive current pulse, per Fig. 3 and derated above  $T_A=25^\circ\text{C}$  per Fig.2
- (2) 8.3ms single half sine-wave or equivalent square wave, duty cycle=4 pulses per minutes maximum

## Electrical Characteristics ( $T_A=25^\circ\text{C}$ unless otherwise noted)

Part Number		Device Marking Code		Breakdown Voltage $V_{BR}@I_T$		Test Current	Max Reverse Leakage @VRWM	Reverse Standoff Voltage	Max Peak Pulse Current	Max Clamping Voltage @Ipp
UNI	BI	UNI	BI	Min.(V)	Max.(V)	IT(mA)	IR(uA)	$V_{RWM}(V)$	IPP(A)	$V_c(V)$
CJSMCJ10A	CJSMCJ10CA	C10A XX <sup>(2)</sup>	C10CA XX	11.14	12.29	1	5	10	88.3	16.8
CJSMCJ11A	CJSMCJ11CA	C11A XX	C11CA XX	12.25	13.49	1	5	11	82.5	18
CJSMCJ12A	CJSMCJ12CA	C12A XX	C12CA XX	13.35	14.69	1	5	12	75.4	19.7
CJSMCJ13A	CJSMCJ13CA	C13A XX	C13CA XX	14.46	15.89	1	5	13	69.8	21.3
CJSMCJ14A	CJSMCJ14CA	C14A XX	C14CA XX	15.66	17.19	1	5	14	64.7	23
CJSMCJ15A	CJSMCJ15CA	C15A XX	C15CA XX	16.77	18.49	1	5	15	61.5	24.2
CJSMCJ16A	CJSMCJ16CA	C16A XX	C16CA XX	17.87	19.69	1	5	16	57.7	25.7
CJSMCJ17A	CJSMCJ17CA	C17A XX	C17CA XX	18.98	20.89	1	5	17	54.4	27.3
CJSMCJ18A	CJSMCJ18CA	C18A XX	C18CA XX	20.08	22.08	1	5	18	51.4	28.9
CJSMCJ20A	CJSMCJ20CA	C20A XX	C20CA XX	22.29	24.48	1	5	20	46.3	32.1
CJSMCJ22A	CJSMCJ22CA	C22A XX	C22CA XX	24.5	26.88	1	5	22	42.3	35.1
CJSMCJ24A	CJSMCJ24CA	C24A XX	C24CA XX	26.81	29.48	1	5	24	38.6	38.5
CJSMCJ26A	CJSMCJ26CA	C26A XX	C26CA XX	29.02	31.88	1	5	26	35.7	41.7
CJSMCJ28A	CJSMCJ28CA	C28A XX	C28CA XX	31.22	34.38	1	5	28	33.1	44.9
CJSMCJ30A	CJSMCJ30CA	C30A XX	C30CA XX	33.43	36.77	1	5	30	31	47.9
CJSMCJ33A	CJSMCJ33CA	C33A XX	C33CA XX	36.85	40.57	1	5	33	28.2	52.8
CJSMCJ36A	CJSMCJ36CA	C36A XX	C36CA XX	40.16	44.17	1	5	36	25.9	57.5
CJSMCJ40A	CJSMCJ40CA	C40A XX	C40CA XX	44.58	49.07	1	5	40	23.3	63.9
CJSMCJ43A	CJSMCJ43CA	C43A XX	C43CA XX	47.99	52.76	1	5	43	21.7	68.7
CJSMCJ45A	CJSMCJ45CA	C45A XX	C45CA XX	50.2	55.26	1	5	45	20.6	72
CJSMCJ48A	CJSMCJ48CA	C48A XX	C48CA XX	53.51	58.86	1	5	48	19.4	76.6
CJSMCJ51A	CJSMCJ51CA	C51A XX	C51CA XX	56.93	62.66	1	5	51	18.2	81.6
CJSMCJ54A	CJSMCJ54CA	C54A XX	C54CA XX	60.24	66.25	1	5	54	17.3	86.2
CJSMCJ58A	CJSMCJ58CA	C58A XX	C58CA XX	64.66	71.15	1	5	58	16.1	92.7
CJSMCJ60A	CJSMCJ60CA	C60A XX	C60CA XX	66.97	73.65	1	5	60	15.5	95.8
CJSMCJ64A	CJSMCJ64CA	C64A XX	C64CA XX	71.39	78.54	1	5	64	14.6	102
CJSMCJ70A	CJSMCJ70CA	C70A XX	C70CA XX	78.11	85.94	1	5	70	13.3	111.9
CJSMCJ75A	CJSMCJ75CA	C75A XX	C75CA XX	83.63	92.04	1	5	75	12.4	119.8
CJSMCJ78A	CJSMCJ78CA	C78A XX	C78CA XX	87.05	95.73	1	5	78	11.9	124.7
CJSMCJ85A	CJSMCJ85CA	C85A XX	C85CA XX	94.78	103.93	1	5	85	11	135.6
CJSMCJ90A	CJSMCJ90CA	C90A XX	C90CA XX	100.4	110.92	1	5	90	10.3	144.5
CJSMCJ100A	CJSMCJ100CA	C100A XX	C100CA XX	111.45	122.91	1	5	100	9.3	160.4

### Notes:

- (1) Waveform of CJSMCJ10A -CJSMCJ100CA are defined as per fig.3
- (2) XX=Code

**Figure 1. Peak Pulse Power Rating Curve**

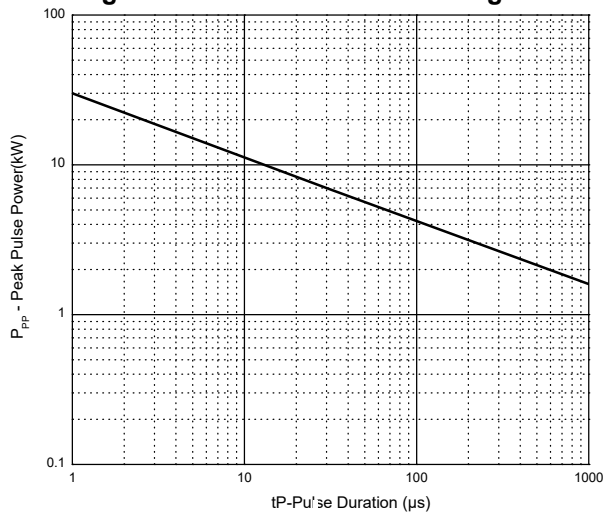

**Figure 2. Pulse Derating Curve**

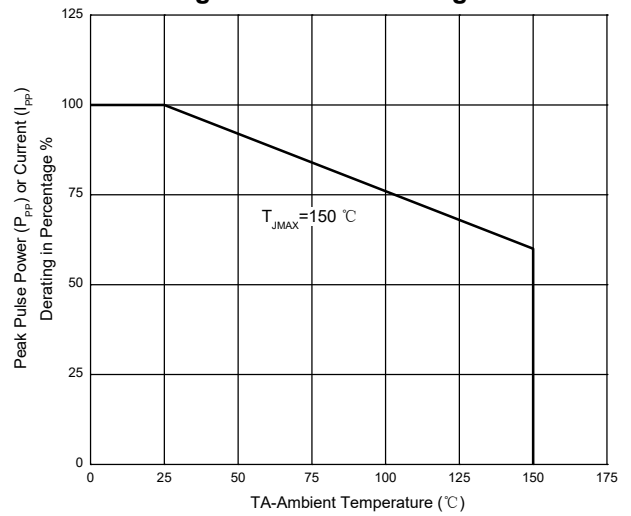

**Figure 3. Pulse Waveform**



**Figure 4. Typical Junction Capacitance**

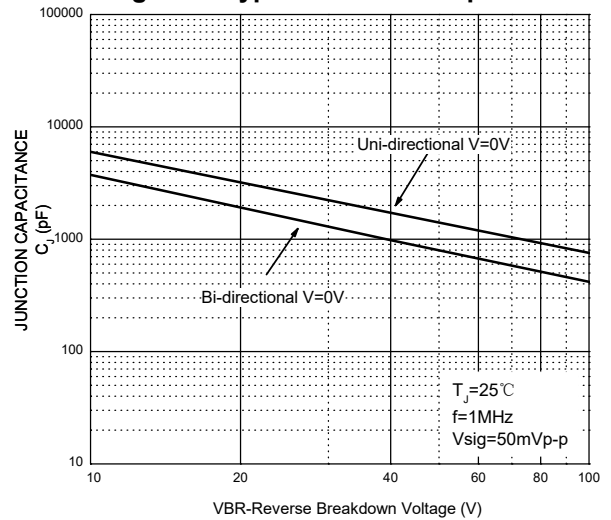

**Figure 5. Steady State Power Dissipation Derating Curve**

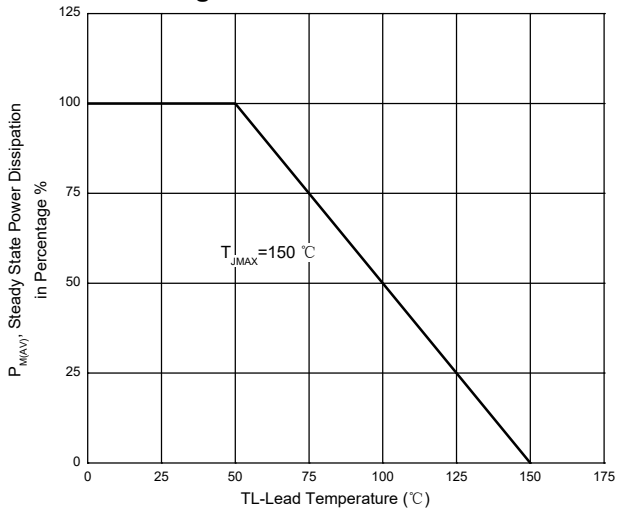

**Figure 6. Maximum Non-Repetitive Forward Surge Current Uni-Directional Only**

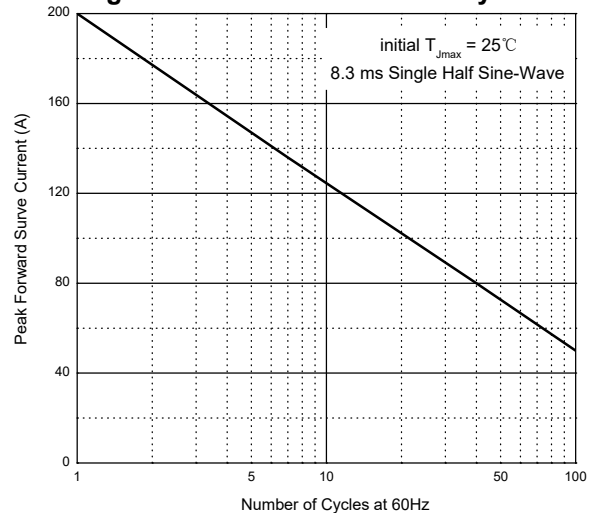

## SMCG Package Outline Dimensions

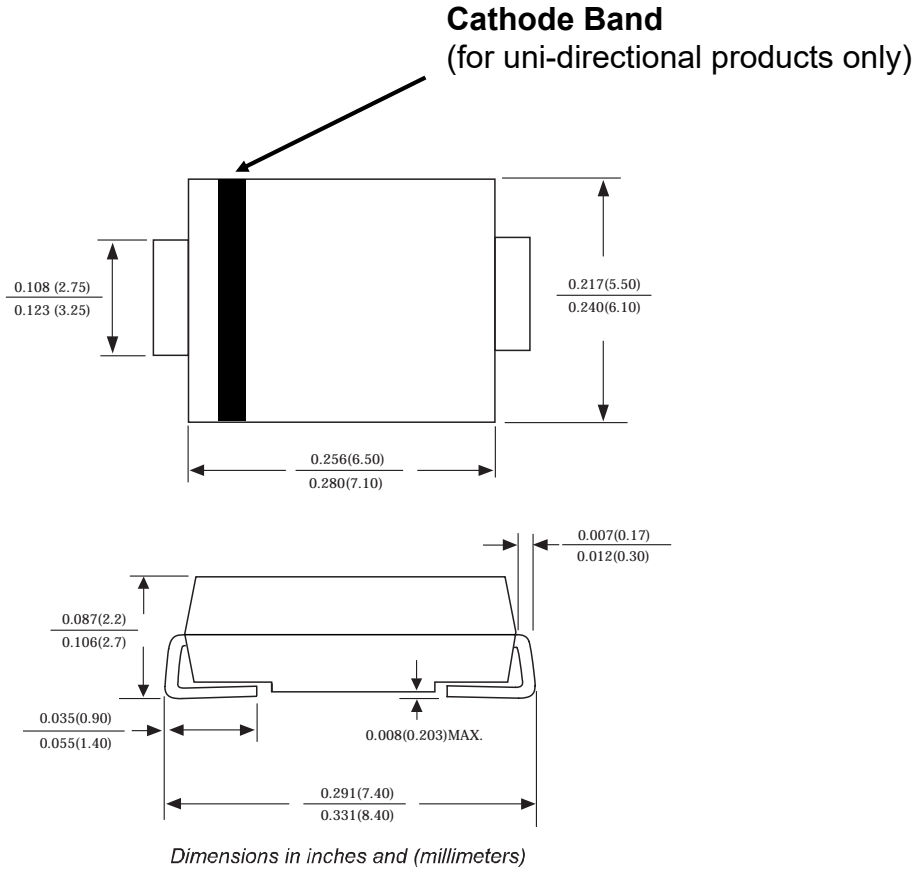

## SMCG Suggested Pad Layout

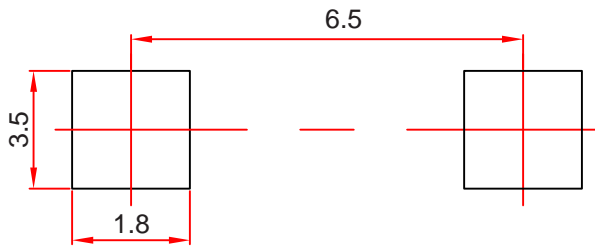

**Note:**

1. Controlling dimension: in millimeters.
2. General tolerance:  $\pm 0.05$ mm.
3. The pad layout is for reference purposes only.

**NOTICE**

JSCJ reserves the right to make modifications, enhancements, improvements, corrections or other changes without further notice to any product herein. JSCJ does not assume any liability arising out of the application or use of any product described herein.

# Reel Taping Specifications For Surface Mount Devices- SMCG

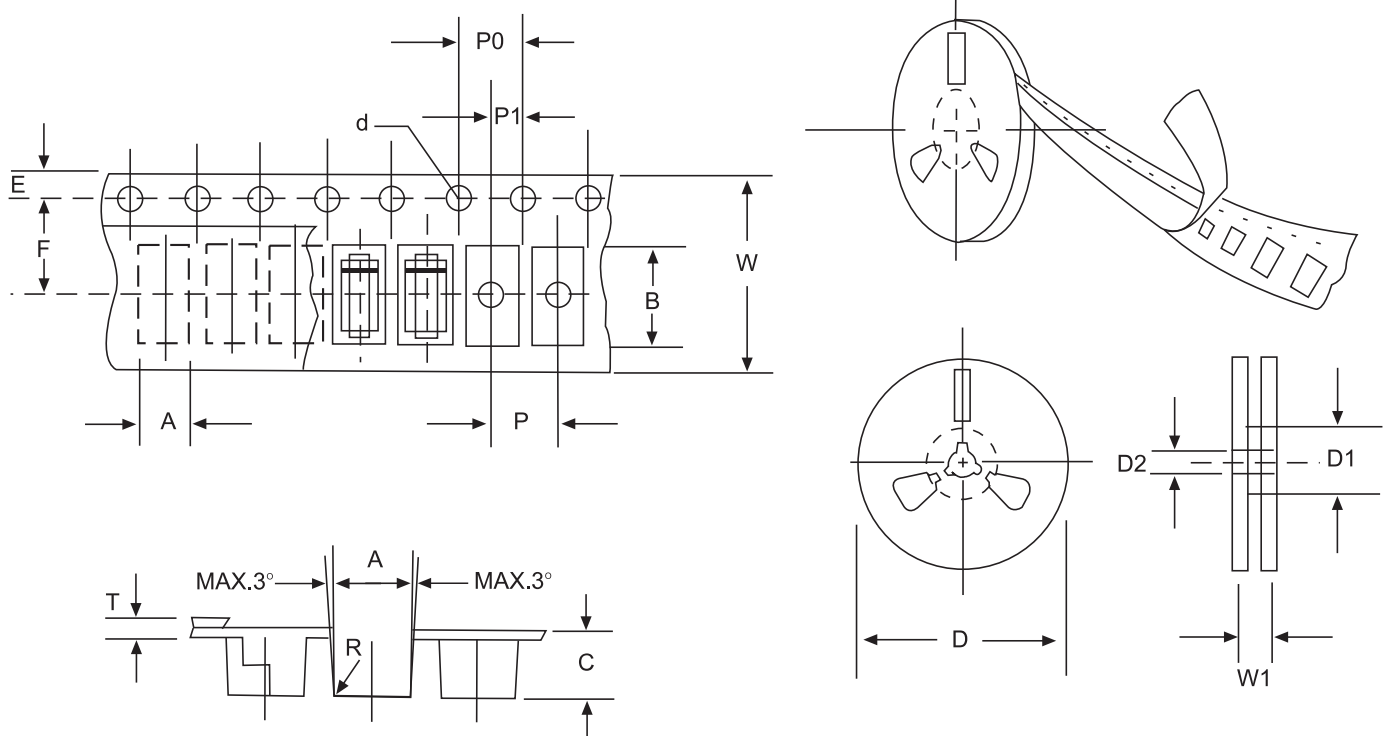

**FIG: CONFIGURATION OF SURFACE MOUNTED DEVICES TAPING**

ITEM	SYMBOL	SMCG mm(inch)
Carrier width	A	6.05±0.1(0.238±0.004)
Carrier length	B	8.31±0.1(0.327±0.004)
Carrier depth	C	2.70±0.1(0.106±0.004)
Sprocket hole	d	1.55±0.05(0.061±0.002)
Reel outside diameter	D	330±2.0(13±0.079)
Reel inner diameter	D1	75 ±1.0 ( 2.95 ±0.039)
Feed hole diameter	D2	13±0.5(0.512±0.020)
Sprocket hole position	E	1.75±0.1(0.069±0.004)
Punch hole position	F	7.65±0.05(0.301±0.002)
Punch hole pitch	P	8.0±0.1(0.315±0.004)
Sprocket hole pitch	P0	4.0±0.1(0.157±0.004)
Embossment center	P1	2.0±0.1(0.079±0.004)
Total tape thickness	T	0.3±0.1(0.012±0.004)
Tape width	W	16.0±0.2(0.630±0.008)
Reel width	W1	24.0±2.0(0.945±0.079)

NOTE: Devices are packed in accordance with EIA standard RS-481-A and specification given above.