

FEATURES

- For surface mounted applications
- Glass Passivated Chip Junction
- Fast reverse recovery time
- Ideal for automated placement
- Lead free in comply with EU RoHS 2011/65/EU directives

MECHANICAL DATA

- Case: SOD-123
- Terminals: Solderable per MIL-STD-750, Method 2026
- Approx. Weight: 16mg/0.00056oz

PINNING

PIN	DESCRIPTION
1	Cathode
2	Anode

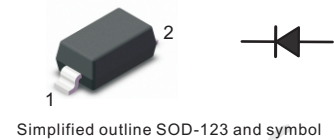
Absolute Maximum Ratings at 25 °C

Parameter	Symbols	1N4148W	Units
Maximum Repetitive Peak Reverse Voltage	V_{RRM}	100	V
Maximum RMS voltage	V_{RMS}	75	V
Continuous Forward Current	I_F	300	mA
Non-reptitive Peak Forward Surge Current at 1ms	I_{FSM}	4	A
Total Power Dissipation	P_{tot}	400	mW
Operating and Storage Temperature Range	T_j, T_{stg}	-55 ~ +150	°C

Characteristics at $T_a = 25\text{ °C}$

Parameter	Symbols	1N4148W	Units
Reverse Breakdown Voltage at $I_R = 1\text{ }\mu\text{A}$	$V_{(BR)R}$	75	V
Maximum Forward Voltage at 1 mA at 10 mA at 50 mA at 150 mA	V_F	0.715 0.855 1.00 1.25	V
Peak Reverse Current at $V_R = 20\text{V}$ $T_j = 25\text{ °C}$ at $V_R = 75\text{V}$ $T_j = 25\text{ °C}$ at $V_R = 25\text{V}$ $T_j = 150\text{ °C}$ at $V_R = 75\text{V}$ $T_j = 150\text{ °C}$	I_R	0.025 1 30 50	μA
Typical Junction Capacitance	C_j	5	pF
Maximum Reverse Recovery Time	t_{rr} Typical	8	ns

Fig.1 Forward Current Derating Curve

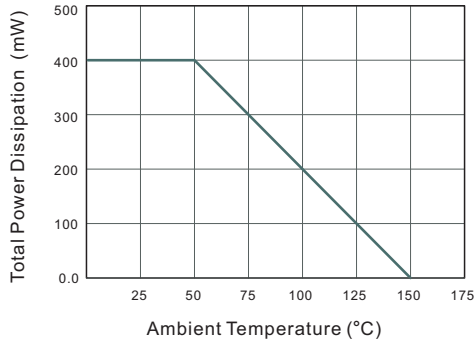

Fig.2 Typical Reverse Characteristics

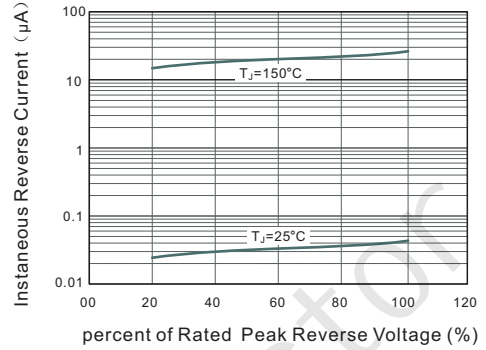

Fig.3 Typical Instantaneous Forward Characteristics

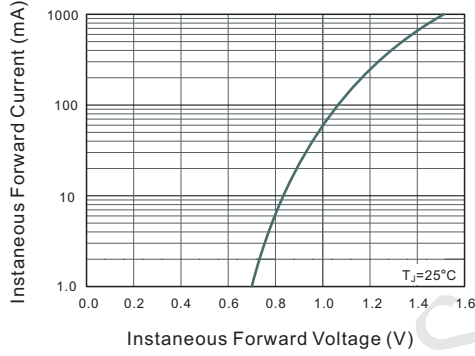
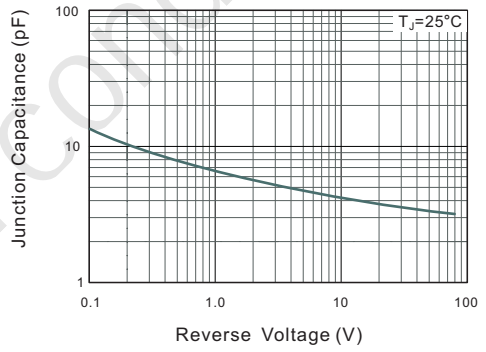

Fig.4 Typical Junction Capacitance



PACKAGE OUTLINE

Plastic surface mounted package; 2 leads

SOD-123

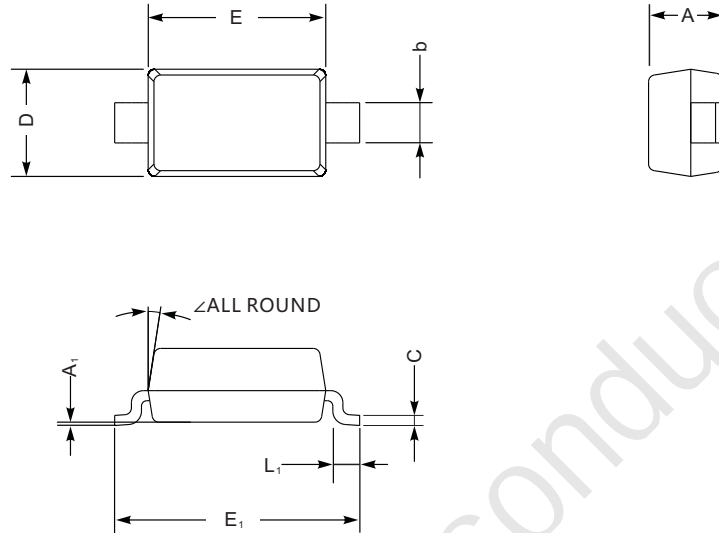

SOD-123 mechanical data

UNIT		A	C	D	E	E ₁	L ₁	b	A ₁	∠
mm	max	1.3	0.22	1.8	2.8	3.9	0.45	0.7	0.2	9°
	min	0.9	0.09	1.5	2.5	3.6	0.25	0.5	—	
mil	max	51	8.7	71	110	154	18	28	8	
	min	35	3.5	59	98	142	10	20	—	

The recommended mounting pad size

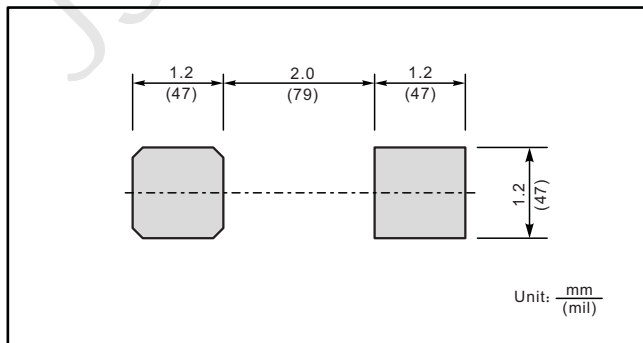

Marking

Type number	Marking code
1N4148W	T4