

Description

The 4606 uses advanced trench technology to provide excellent $R_{DS(ON)}$ and low gate charge. The complementary MOSFETs may be used to form a level shifted high side switch, and for a host of other applications.

General Features
● N-Channel

$$V_{DS} = 30V, I_D = 6.9A$$

$$R_{DS(ON)} < 21m\Omega @ V_{GS}=10V$$

$$R_{DS(ON)} < 32m\Omega @ V_{GS}=4.5V$$

● P-Channel

$$V_{DS} = -30V, I_D = -6.0A$$

$$R_{DS(ON)} < 45m\Omega @ V_{GS}=-10V$$

$$R_{DS(ON)} < 60m\Omega @ V_{GS}=-4.5V$$

- High power and current handing capability
- Lead free product is acquired
- Surface mount package

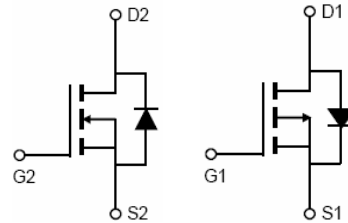
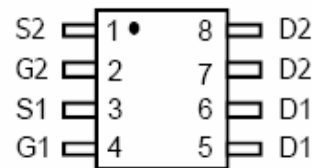
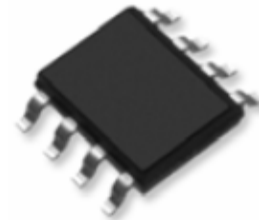
N-channel
P-channel
Schematic diagram

Marking and pin assignment

SOP-8 top view
Absolute Maximum Ratings ($T_A=25^\circ C$ unless otherwise noted)

Parameter		Symbol	N-Channel	P-Channel	Unit
Drain-Source Voltage		V_{DS}	30	-30	V
Gate-Source Voltage		V_{GS}	± 20	± 20	V
Continuous Drain Current	$T_A=25^\circ C$	I_D	6.9	-6.0	A
Pulsed Drain Current ^(Note 1)		I_{DM}	28	-26	A
Maximum Power Dissipation	$T_A=25^\circ C$	P_D	2.0	2.0	W
Operating Junction and Storage Temperature Range		T_J, T_{STG}	-55 To 150	-55 To 150	$^\circ C$

Thermal Characteristic

Thermal Resistance, Junction-to-Ambient ^(Note2)	$R_{\theta JA}$	N-Ch	63.5	$^\circ C/W$
Thermal Resistance, Junction-to-Ambient ^(Note2)	$R_{\theta JA}$	P-Ch	63.5	$^\circ C/W$

N-CH Electrical Characteristics (T_A=25°C unless otherwise noted)

Parameter	Symbol	Condition	Min	Typ	Max	Unit
Off Characteristics						
Drain-Source Breakdown Voltage	BV _{DSS}	V _{GS} =0V, I _D =250μA	30	-	-	V
Zero Gate Voltage Drain Current	I _{DSS}	V _{DS} =24V, V _{GS} =0V	-	-	50	μA
Gate-Body Leakage Current	I _{GSS}	V _{GS} =±20V, V _{DS} =0V	-	-	±100	nA

On Characteristics (Note 3)

Gate Threshold Voltage	V _{GS(th)}	V _{DS} =V _{GS} , I _D =250μA	1.2	1.6	2.4	V
Drain-Source On-State Resistance	R _{DS(ON)}	V _{GS} =10V, I _D =6.9A	-	19	21	mΩ
		V _{GS} =4.5V, I _D =5A	-	29	32	mΩ
Forward Transconductance	g _{FS}	V _{DS} =5V, I _D =5.0A	5	-	-	S

Dynamic Characteristics (Note4)

Input Capacitance	C _{ISS}	V _{DS} =15V, V _{GS} =0V, F=1.0MHz	-	398	-	PF
Output Capacitance	C _{OSS}		-	67	-	PF
Reverse Transfer Capacitance	C _{RSS}		-	61	-	PF

Switching Characteristics (Note 4)

Turn-on Delay Time	t _{d(on)}	V _{DD} =15V, R _L =15Ω V _{GS} =10V, R _{GEN} =6Ω I _D =1.0A	-	8.0	-	nS
Turn-on Rise Time	t _r		-	11.5	-	nS
Turn-Off Delay Time	t _{d(off)}		-	17	-	nS
Turn-Off Fall Time	t _f		-	7.5	-	nS
Total Gate Charge	Q _g	V _{DS} =10V, I _D =1.0A, V _{GS} =10V	-	7.5	-	nC
Gate-Source Charge	Q _{gs}		-	1.7	-	nC
Gate-Drain Charge	Q _{gd}		-	1.3	-	nC

Drain-Source Diode Characteristics

Diode Forward Voltage (Note 3)	V _{SD}	V _{GS} =0V, I _S =2A	-	0.75	1.0	V
--------------------------------	-----------------	---	---	------	-----	---

Notes:

1. Repetitive Rating: Pulse width limited by maximum junction temperature.
2. Surface Mounted on FR4 Board, t ≤ 10 sec.
3. Pulse Test: Pulse Width ≤ 300μs, Duty Cycle ≤ 2%.
4. Guaranteed by design, not subject to production

Characteristics Curve(N-Channel)

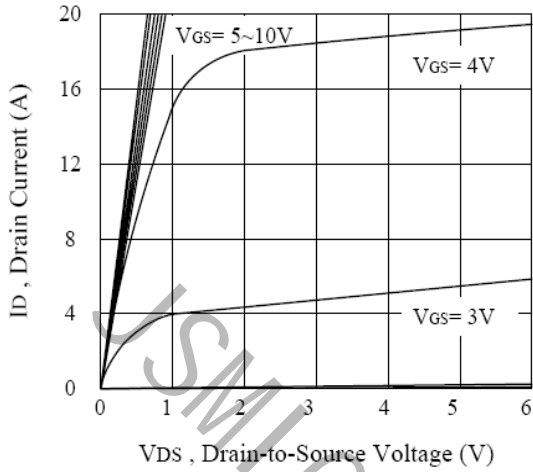

Figure 1. Output Characteristics

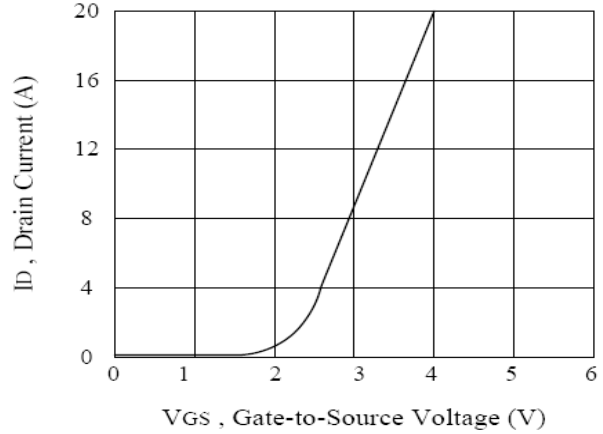

Figure 2. Transfer Characteristics

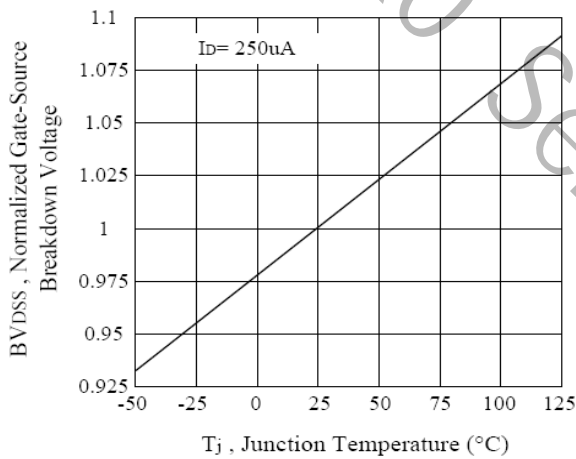

Figure 3. Breakdown Voltage Variation with Temperature

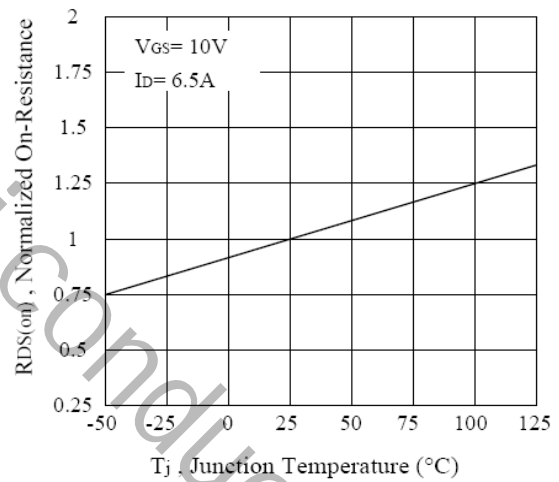

Figure 4. On-Resistance Variation with Temperature

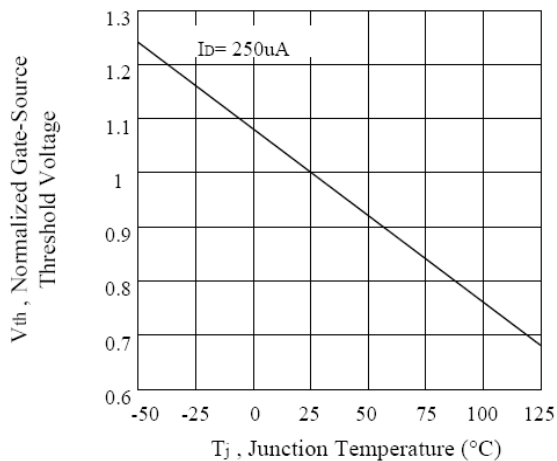
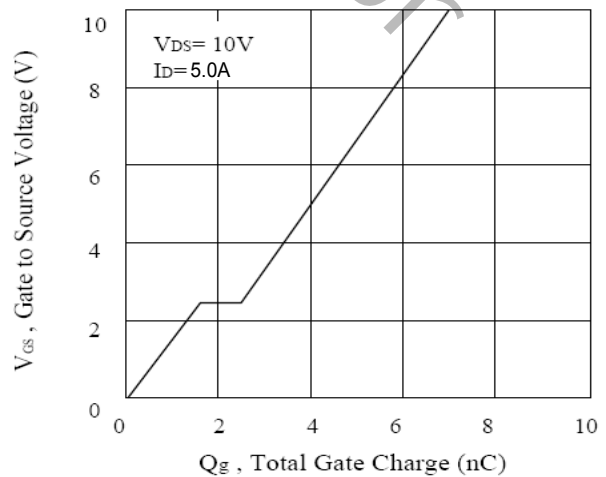
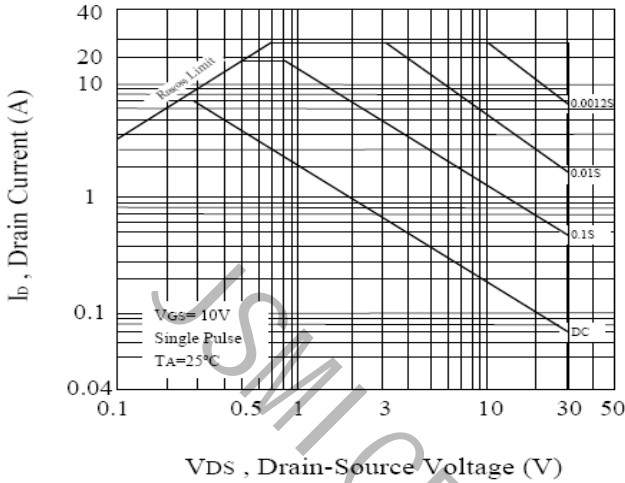

Figure 5. Gate Threshold Variation with Temperature



Characteristics Curve(N-Channel)



VDS, Drain-Source Voltage (V)
Figure 7. Maximum Safe Operating Area

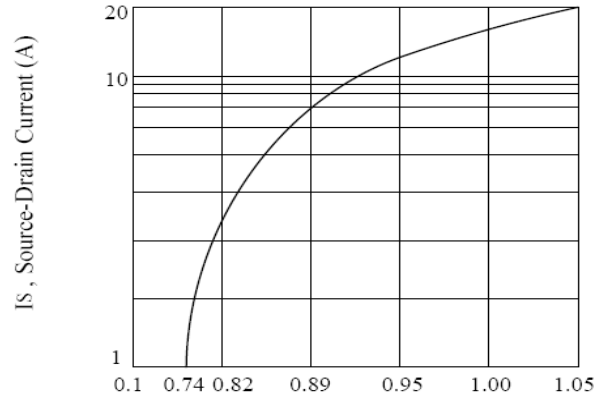

VSD, Body Diode Forward Voltage (V)
Figure 8. Body Diode Forward Voltage Variation with Source Current

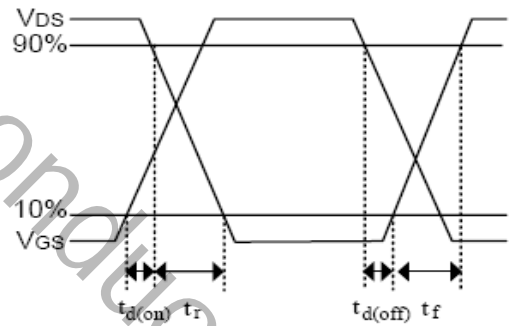
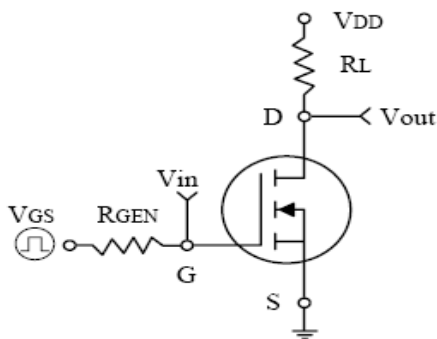

Figure 9. Switching Test Circuit and Switching Waveforms

P-CH Electrical Characteristics (T_A=25°C unless otherwise noted)

Parameter	Symbol	Condition	Min	Typ	Max	Unit
Off Characteristics						
Drain-Source Breakdown Voltage	BV _{DSS}	V _{GS} =0V, I _D =-250μA	-30	-	-	V
Zero Gate Voltage Drain Current	I _{DSS}	V _{DS} =-24V, V _{GS} =0V	-	-	-50	μA
Gate-Body Leakage Current	I _{GSS}	V _{GS} =±20V, V _{DS} =0V	-	-	±100	nA

On Characteristics (Note 3)

Gate Threshold Voltage	V _{GS(th)}	V _{DS} =V _{GS} , I _D =-250μA	-1.0	-1.3	-2.0	V
Drain-Source On-State Resistance	R _{DS(on)}	V _{GS} =-10V, I _D =-6.0A	-	42	45	mΩ
		V _{GS} =-4.5V, I _D =-5.0A	-	55	60	mΩ
Forward Transconductance	g _{FS}	V _{DS} =-5V, I _D =-5.0A	10	-	-	S

Dynamic Characteristics (Note 4)

Input Capacitance	C _{iss}	V _{DS} =-15V, V _{GS} =0V, F=1.0MHz	-	930	-	PF
Output Capacitance	C _{oss}		-	121	-	PF
Reverse Transfer Capacitance	C _{rss}		-	102	-	PF

Switching Characteristics (Note 4)

Turn-on Delay Time	t _{d(on)}	V _{DD} =-15V, R _L =5.0Ω V _{GS} =-10V, R _{GEN} =6Ω I _D =-3.0A	-	9.5	-	nS
Turn-on Rise Time	t _r		-	5.4	-	nS
Turn-Off Delay Time	t _{d(off)}		-	42.5	-	nS
Turn-Off Fall Time	t _f		-	13.6	-	nS
Total Gate Charge	Q _g	V _{DS} =-15V, I _D =-3.0A V _{GS} =-10V	-	20	-	nC
Gate-Source Charge	Q _{gs}		-	4.1	-	nC
Gate-Drain Charge	Q _{gd}		-	2.6	-	nC

Drain-Source Diode Characteristics

Diode Forward Voltage (Note 3)	V _{SD}	V _{GS} =0V, I _S =-2.0A	-	0.75	-1.0	V
--------------------------------	-----------------	--	---	------	------	---

Notes:

1. Repetitive Rating: Pulse width limited by maximum junction temperature.
2. Surface Mounted on FR4 Board, t ≤ 10 sec.
3. Pulse Test: Pulse Width ≤ 300μs, Duty Cycle ≤ 2%.
4. Guaranteed by design, not subject to production

Characteristics Curve(P-Channel)

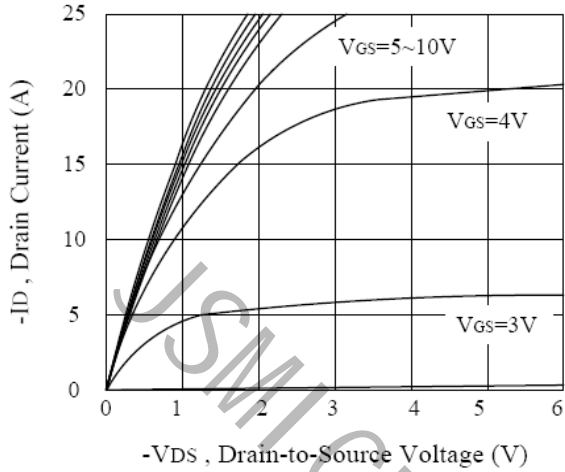

Figure 11. Output Characteristics

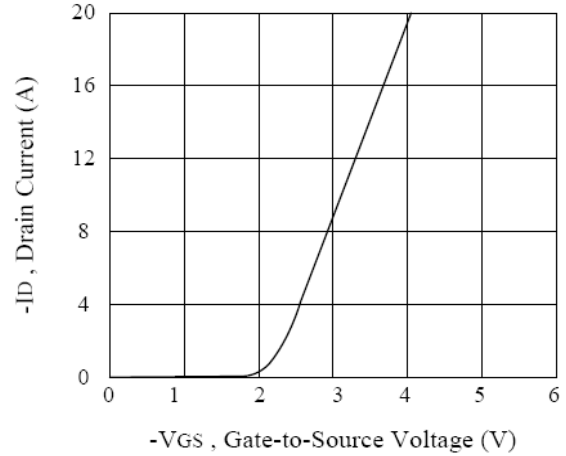

Figure 12. Transfer Characteristics

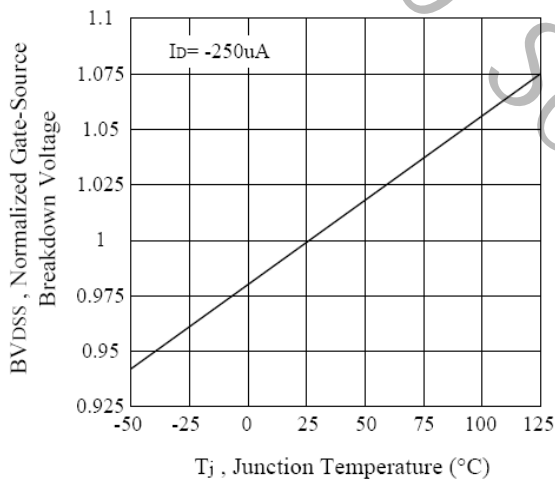

Figure 13. Breakdown Voltage Variation with

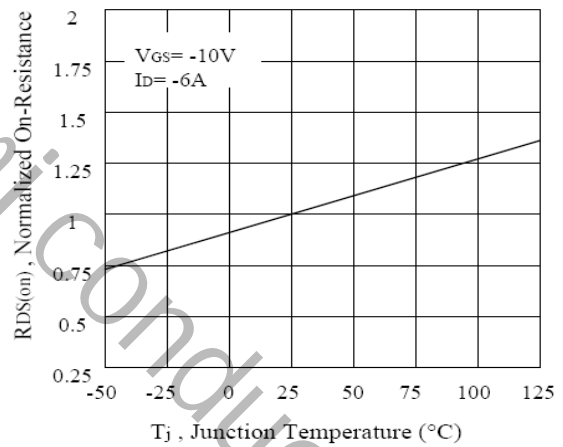

Figure 13. On-Resistance Variation with Temperature

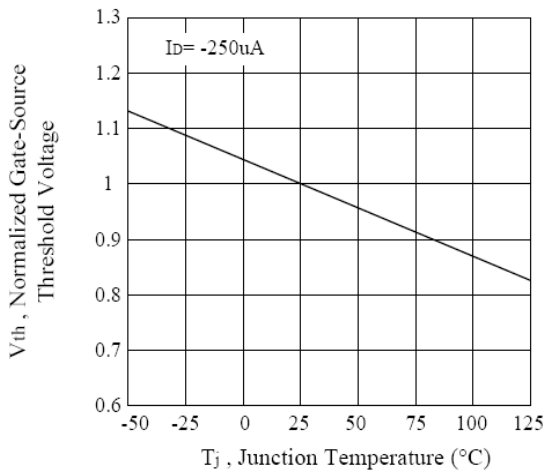

Figure 15. Gate Threshold Variation with Temperature

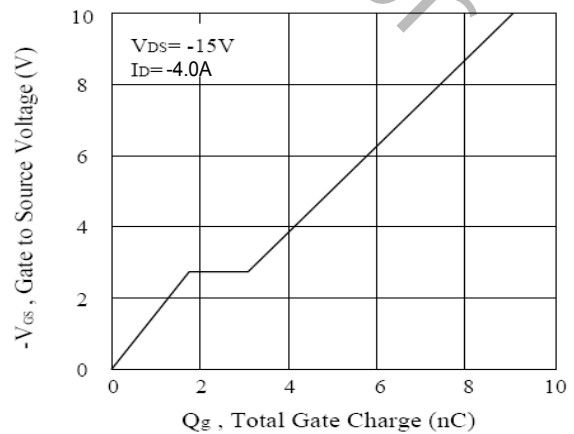
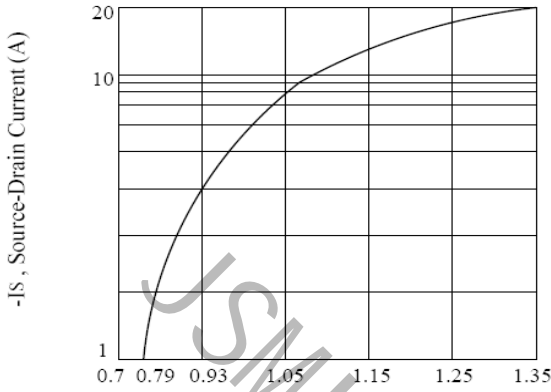
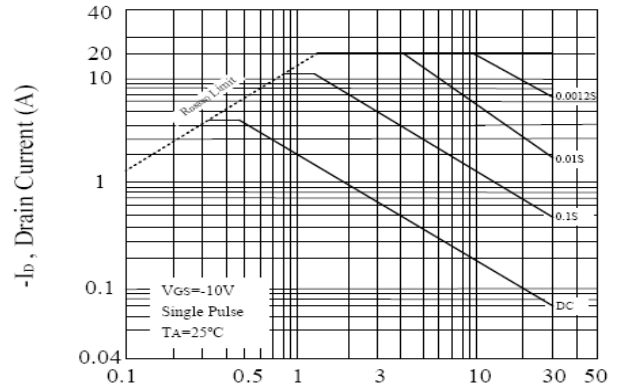

Figure 15. Gate Charge

Characteristics Curve(P-Channel)



-VSD, Body Diode Forward Voltage (V)
Figure 16 Body Diode Forward Voltage Variation with Source Current



-VDS, Drain-Source Voltage (V)
Figure 17. Maximum Safe Operating Area

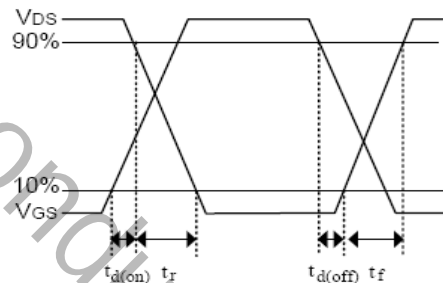
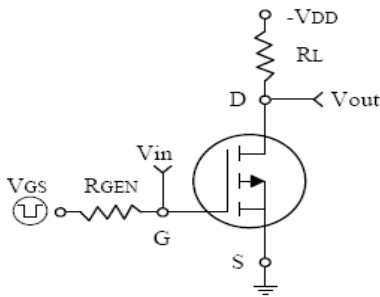
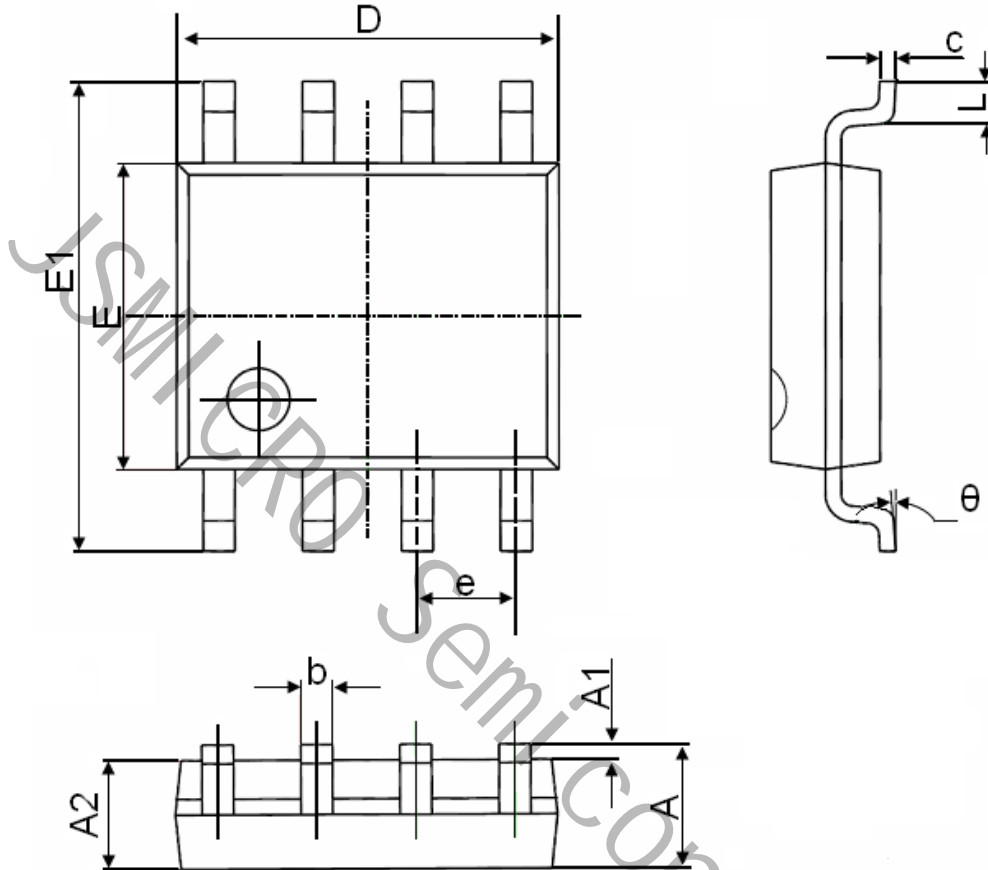

Figure 18 Switching Test Circuit and Switching Waveforms

SOP-8 Package Information

Symbol	Dimensions In Millimeters		Dimensions In Inches	
	Min.	Max.	Min.	Max.
A	1.350	1.750	0.053	0.069
A1	0.100	0.250	0.004	0.010
A2	1.350	1.550	0.053	0.061
b	0.330	0.510	0.013	0.020
c	0.170	0.250	0.006	0.010
D	4.700	5.100	0.185	0.200
E	3.800	4.000	0.150	0.157
E1	5.800	6.200	0.228	0.244
e	1.270(BSC)		0.050(BSC)	
L	0.400	1.270	0.016	0.050
theta	0°	8°	0°	8°