



# 深圳市拓展光电有限公司

TuoZhan Optoelectronics Company Limited

## 产品规格书

### Product Specification

产品料号/ <b>Part No.</b>	P4-1615G2B2R4TS2-06T-001-24		
产品名称/ <b>Product Name</b>	1615翠绿蓝红共阳		
客户名称/ <b>Customer Name</b>			
客户料号/ <b>Customer No</b>			
生效日期/ <b>Effective Date</b>			
制作 <b>Prepared</b>	审核 <b>Checked</b>	核准 <b>Approved</b>	业务 <b>Sales</b>
客户确认（盖章） <b>Customer confirmation（Stamp）</b>			

地址：深圳市宝安区西乡铁岗宝田一路 369 号

TEL:0755-29632541

Address: No.369,Baotian Road,Tiegang,xixiang,Baoan District, Shenzhen

Tel:0755-29632541

注：如中英译文有冲突请以中文为准。

Note: In case of any conflict between Chinese and English translations, the Chinese version shall prevail.





## P4-1615G2B2R4TS2-06T-001-24 Datasheet

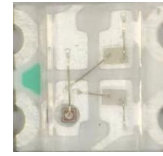

1615 small patch LED lamp bead is a kind of small lamp bead with the characteristics of high light intensity, low power consumption, high reliability, energy saving and environmental protection, long service life, strong and durable. It can be used in digital products, household appliances, display screen, outdoor decoration, industrial lighting and other applications.

1615小贴片LED灯珠是一种具有光强度高、功耗低、可靠性高、节能环保、寿命长、坚固耐用等特点的小灯珠，可应用于数码产品、家用电器、显示屏、户外装饰、工业照明等方面。

This part has a footprint that is compatible to most of LEDs with similar size.

此器件可与大部份外形尺寸相似的LED兼容使用

### FEATURES/特点

- High luminous Intensity and high efficiency  
发光强度高，效率高
- sturdy and durable坚固耐用
- Long operation life/寿命长
- Wide viewing angle at 120°  
120° 发光角度
- Epoxy resin package/环氧树脂封装
- Environmental friendly, RoHS compliance  
材质环保，符合RoHS要求

### APPLICATIONS/应用

- Digital products/数码产品
- household appliances/家用电器
- display screen/显示屏
- outdoor decoration/户外装饰
- industrial lighting/工业照明



外观尺寸及建议焊盘尺寸: **Size of Appearance & Suggested Soldering PAD**

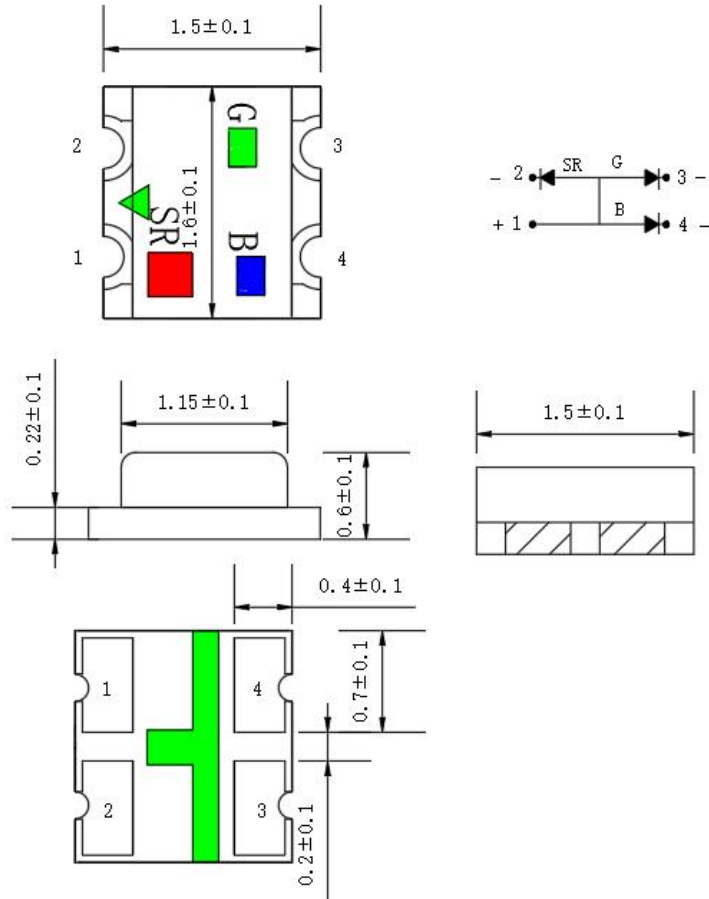

Recommended Solder Pad Design 推荐焊盘设计

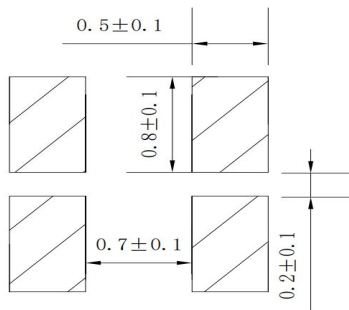

For reflow soldering

Notes/ 注:

1. All dimensions in millimeters.所有尺寸单位为mm
2. Tolerance is  $\pm 0.1\text{mm}$  unless otherwise noted. 如未特别注明, 默认公差为 $\pm 0.1\text{mm}$



## ABSOLUTE MAXIMUM RATINGS 最大限定参数 (Ta=25°C)

Parameter 参数	Symbol 符号	Value 额定值	Unit 单位
Power Dissipation 消耗功率	Pd	SR:60 G/B:90	mW
Max Pulse Current 最大脉冲电流	IFP	40	mA
DC Forward Current 正向直流工作电流	IF	30	mA
Reverse breakdown Voltage 反向电压	VR	5	V
Electrostatic Discharge Threshold (HBM) 抗静电能力	ESD	SR:2500 G/B:2000	V
Operating Temperature 工作环境温度	Topr	-40 to 85°C	°C
Storage Temperature 储存环境温度	Tstg	-40 to 85°C	°C
Soldering Temperature 焊接温度	Tsol	Reflow soldering (回流焊): 260°C/10S Hands soldering (手工焊): 320°C/3S	°C

## CHARACTERISTICS 光电参数 (Ta=25°C)

Parameter 项目名称	Symbol 符号	Condition n 条件	Min 最小值		Typ 中间值	Max 最大值	Unit 单位
			SR	G	B		
Luminous Intensity 亮度	Iv	IF=5mA	SR	70	---	90	mcd
			G	250	---	350	
			B	60	---	80	
Dominant wavelength 主波长	λ d	IF=5mA	SR	620	---	625	nm
			G	526	---	529	
			B	466	---	469	
Forward Voltage 正向电压	VF	IF=5mA	SR	1.8	---	2.2	V
			G	2.5	---	2.9	
			B	2.6	---	3.0	
Reverse Current 反向漏电流	IR	VR=5V	---	---	3	uA	
Half Power View 半功率视角	2 θ 1/2	IF=5mA	---	120	---	deg	

### Notes/注:

- The above forward voltage measurement allowance tolerance is 0.1V. 以上所示电压测量误差 0.1V.
- The above luminous intensity measurement allowance tolerance ±10%. 上述发光强度的测试允许公差为±10%.
- Dominant wavelength is measured with an accuracy of ± 2nm. 主波长的测量精度为± 2nm.
- All measurements were made under the standardized environment of Tuozhan  
所有的测量都是在拓展的标准环境下进行的



**RELATIVE SPECTRAL POWER DISTRIBUTION 相对光谱功率分布 ( $T_j=25^\circ\text{C}$ )**

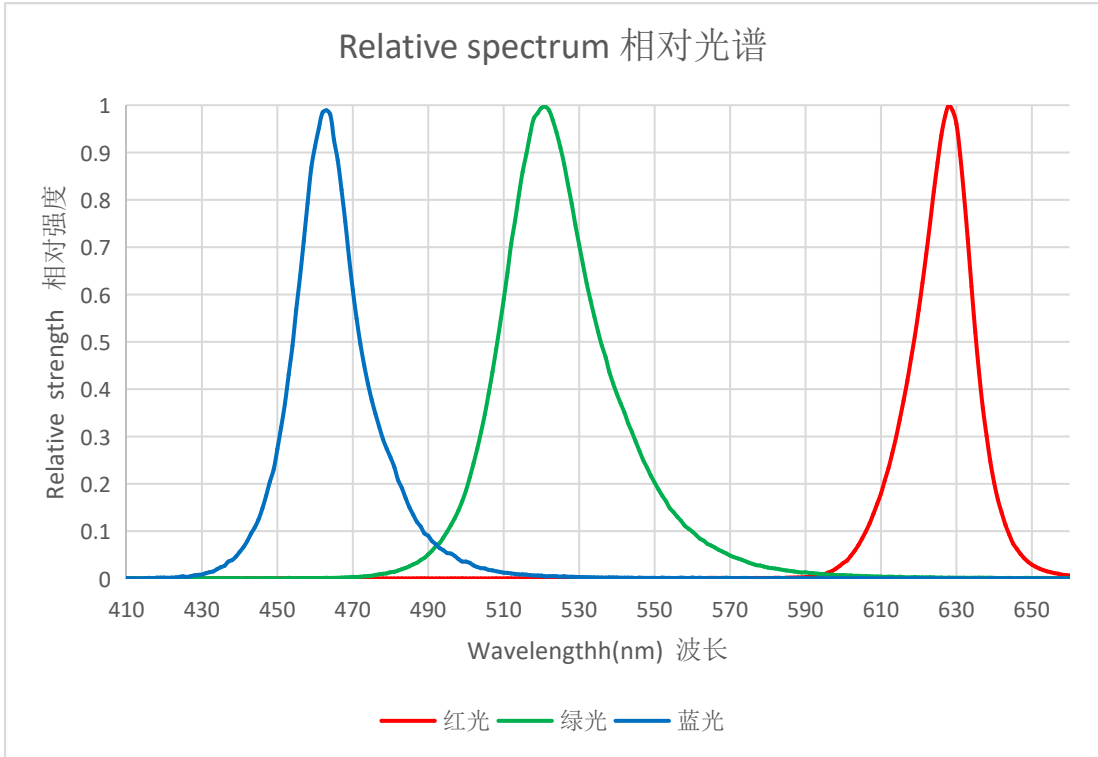

**CURRENT VS. Luminous intensity 电流与发光强度**

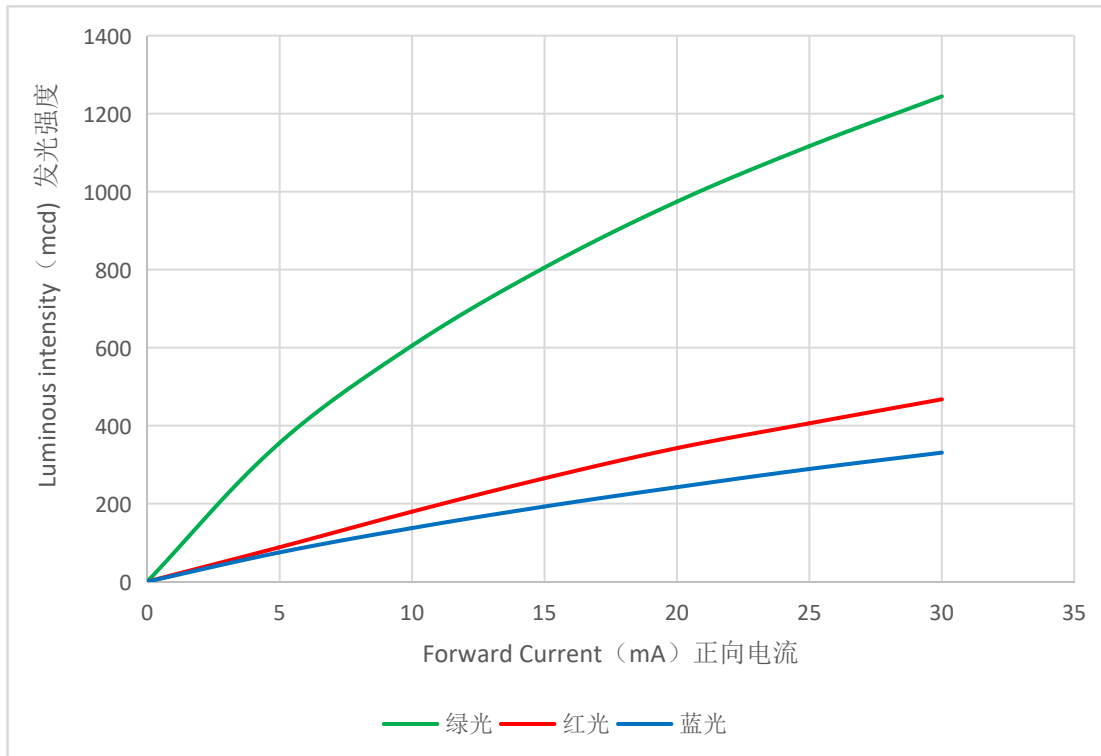



## ELECTRICAL CHARACTERISTICS 电特性(Tj=25°C)

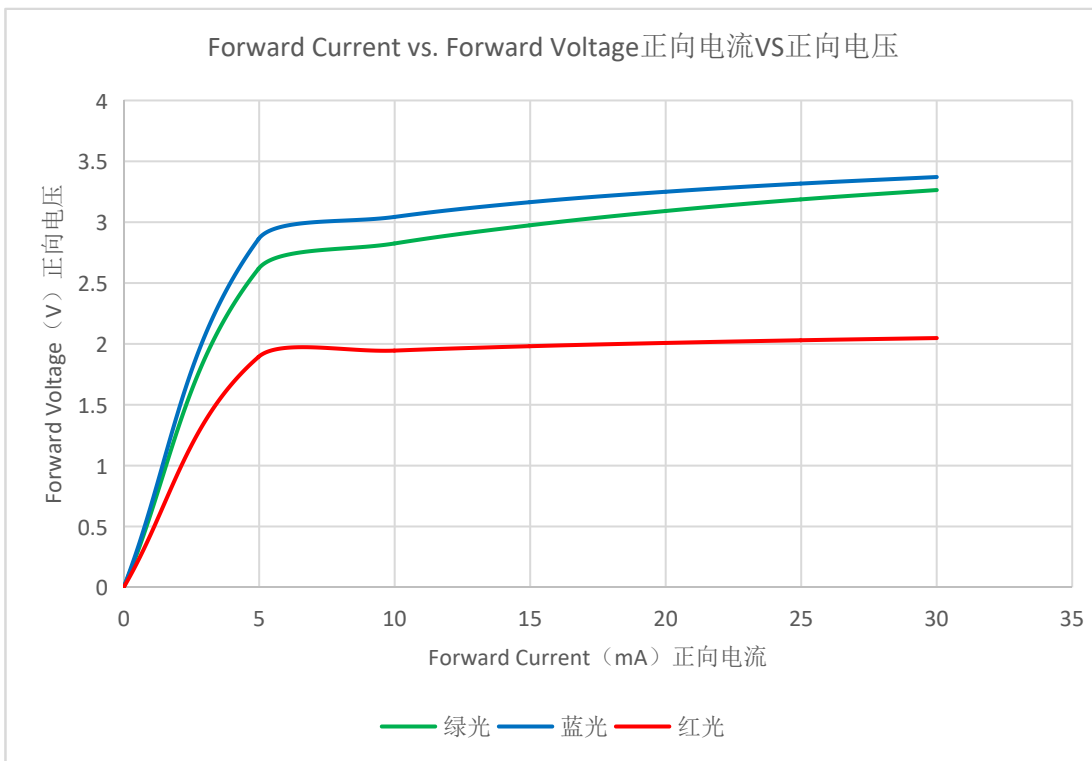

## REFLOW SOLDERING CHARACTERISTICS 回流焊特性

For Reflow Process 回流焊制程:

Preheating 预热 : 140°C~160°C±5°C, within 2 minutes. 2分钟

Operation heating 作业加热 : 260°C(Max.) within 10 seconds.(Max)

260°C(最高) within 10 seconds.(最长)

Gradual Cooling (Avoid quenching). 逐渐冷却(避免淬火)

Lead solder 有铅焊接		Lead-free solder 无铅焊接	
Pre-heat 预热	120-150°C	Pre-heat 预热	150-200°C
Pre-heat time 预热时间	120 sec.Max.	Pre-heat time 预热时间	120 sec.Max.
Peak Temperature 峰值温度	240°C Max.	Peak Temperature 峰值温度	260°C Max.
Soldering time condition 回流焊时间	10 sec.Max.	Soldering time condition 回流焊时间	10 sec.Max.

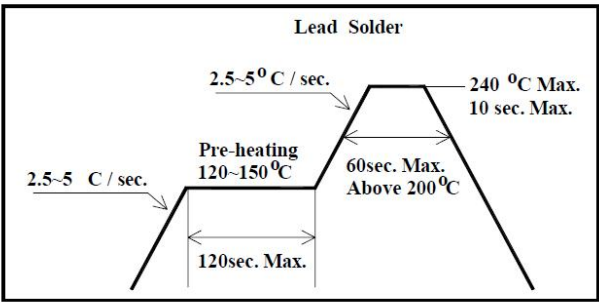
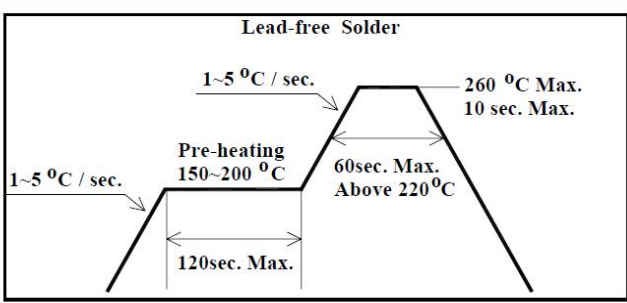

Lead Solder	Lead-free Solder
 <p>The diagram shows a reflow profile for Lead Solder. It starts with a ramp at 2.5-5 °C/sec. This is followed by a pre-heating plateau at 120-150 °C for a maximum of 120 seconds. The temperature then rises to a peak of 240 °C Max. at a rate of 2.5-5 °C/sec. The peak is maintained for a maximum of 10 seconds. Finally, the temperature is cooled down at 2.5-5 °C/sec. A note indicates that the pre-heating time above 200 °C is a maximum of 60 seconds.</p>	 <p>The diagram shows a reflow profile for Lead-free Solder. It starts with a ramp at 1-5 °C/sec. This is followed by a pre-heating plateau at 150-200 °C for a maximum of 120 seconds. The temperature then rises to a peak of 260 °C Max. at a rate of 1-5 °C/sec. The peak is maintained for a maximum of 10 seconds. Finally, the temperature is cooled down at 1-5 °C/sec. A note indicates that the pre-heating time above 220 °C is a maximum of 60 seconds.</p>





## TAPE AND REEL 编带NO.1

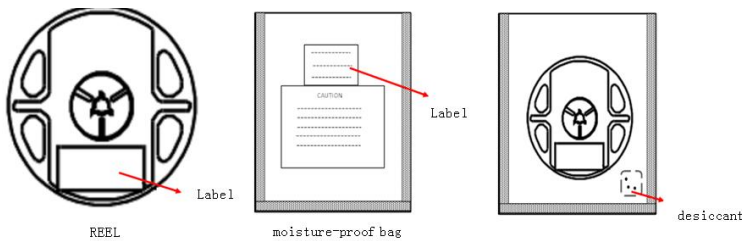
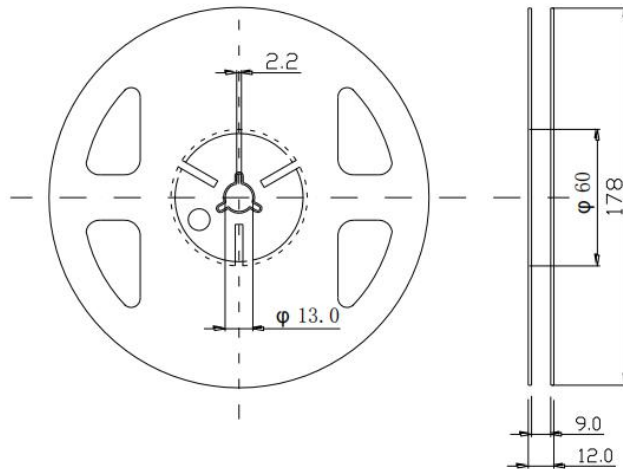
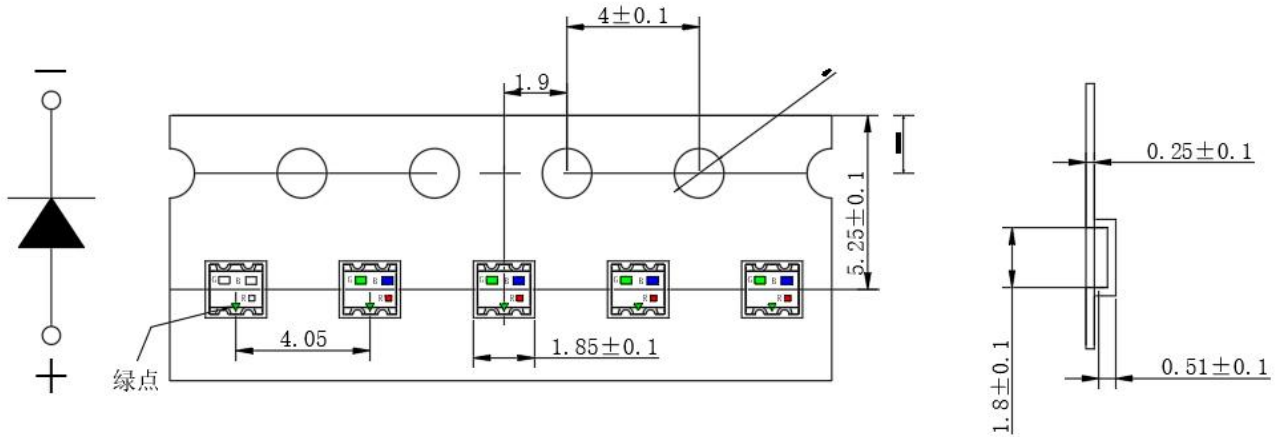

### Notes注:

- (1) Quantity : 4,000pcs/Reel  
数量: 4000pcs/卷
- (2) Cumulative Tolerance : Cumulative Tolerance/10 pitches to be  $\pm 0.2\text{mm}$   
累积公差: 累积公差/10间距  $\pm 0.2$ 毫米
- (3) Adhesion Strength of Cover Tape : Adhesion strength to be 20-40N when the cover tape is turned off from the carrier tape at the angle of  $10^\circ$  to the carrier tape  
盖带粘附强度: 盖带反向拉, 与载带角度为  $10^\circ$ , 拉力为 20-40N
- (4) Package : P/N, Manufacturing data Code No. and quantity to be indicated on a damp proof Package.  
包装: 品名, 生产数据代码和数量须在防潮包装上注明



**Reliability Test Items 可靠性测试项目**

Test Items 测试项目	Test Duration 测试时长	Number of Damaged 不良数
Steady State Operating Life of High Temperature (HTOL) Ts=85°C, IF=Max 高温点亮稳态老化Ts=85°C, IF=最大值	1000hrs	0/20
Steady State Operating Life of Low Temperature (LTOL) Ta=-40°C, IF=Max 低温点亮稳态老化Ts=85°C, IF=最大值	1000hrs	0/20
Pulse Wet Operating Life of High Temperature (PWHTOL) 高温高湿通断电老化 60°C/90%RH, IF30mins ON/30min OFF	500hrs	0/20
High Temperature Storage (HTS) 高温存储 100°C	1000hrs	0/20
Low Temperature Storage (LTS) 低温存储 -40°C	1000hrs	0/20
Thermal Shock (TS) -45°C~125°C 30min dwell 20sec transfer 冷热冲击-45°C 30min~125°C 30min, 转换时间20秒	300cycles	0/20
Solder Resistance (SR) 265°C, 3X MSL 阻焊测试 (3遍潮气敏感度试验后)	5sec	0/20
Solder Ability (SA) 245°C5sec, 95% coverage 可焊性 95%覆盖	5sec	0/11
Mechanical Shock (MS) 1500G 0.5msec pulse shock 机械冲击(MS) 1500G 0.5毫秒脉冲冲击	Each6 axis	0/6
Random Vibration (RV) 随机振动 6G RMS, 10-2000Hz, 10min	Per axis	0/6
Variable Vibration Frequency (VVF) 10-2000-10Hz, log or linear sweep rate, 20G for 1 min, 1.5mm each apply 3x per axis over 变频振动(VVF) 10-2000-10Hz, 对数或线性扫频, 20G, 1分钟, 1.5mm, 每轴3遍以上	6hrs	0/6
Salt Spread (SS) 35°C, 30g/m2/day 盐雾试验35°C,30克/平方米/天	48hrs	0/11

Item 项目	Symbol 符号	Test Condition 测试条件	Criteria for Judgment 判定标准	
			Min. 最小	Max. 最大
Forward Voltage 正向电压	V <sub>F</sub>	IF=Typical Current 典型电流		U.S.L x1.1
Light intensity 光强	mW	IF=Typical Current	L.S.L x0.7	
peak wavelength 峰值波长	nm	IF=Typical Current		U.S.L x1.1

U.S.L: Upper standard level 规格上限 L.S.L: Lower standard level 规格下限

Note: 备注

The technical information shown in the datasheet is limited to the typical characteristics, just for reference. It can't be guarantee of any application condition and method.以上技术数据仅为产品的典型值, 只作为参考, 不作 为任何应用条件及应用方式的保证。



## PRECAUTION FOR USE 使用注意事项

---

(1) This device should not be used in any type of fluid such as water, oil, organic solvent, etc. When washing is required, IPA should be used.

本器件不得用于水、油、有机溶剂等任何流体中。如需清洁，请使用异丙醇进行清洗。

(2) When the LEDs are illuminating, operating current should be decided after considering the ambient maximum temperature.

当LED发光工作时，应根据环境最高温度来确定工作电流。

(3) LEDs must be stored to maintain a clean atmosphere. If the LEDs are stored for 3 months or more after being shipped from TuoZhan, a sealed container with a nitrogen atmosphere should be used for storage.

LED储存环境须保持清洁。如果LED从拓展发货后需储存3个月或更长时间，则应使用氮气柜进行储存。

(4) The LEDs must be used within seven days after opening the moisture proof packing.

Repack unused Products with anti-moisture packing, fold to close any opening and then store in a dry place.

LED须在打开防潮包装后七天内使用。用防潮包装重新包装未使用的产品，折叠以封住开口，然后存放在干燥的地方。

(5) The appearance and specifications of the product may be modified for improvement without notice.

产品外观及规格如有改进，恕不另行通知。

(6) This LED is sensitive to the static electricity and surge. It is recommended to use a wrist Band or anti-electrostatic glove when handling the LEDs.

LED对静电和浪涌很敏感。在处理LED时，建议使用防静电腕带或防静电手套。

(7) On manual soldering, a solder tip must be needed as grounded for usage. If over voltage which exceeds the absolute maximum rating is applied to LEDs, it will cause damage LEDs and result in destruction. Damaged LEDs will show some unusual characteristics such as leak current remarkably increase, turn-on voltage becomes lower and the LEDs get unlighted at low current.

手工焊接时，焊接头必须接地。如果对led施加超过绝对最大额定值的过电压，会对led造成损坏。损坏的led会出现一些不寻常的特性，如漏电流明显增加，接通电压降低，低电流时led不亮。