

**60V NPN LOW SATURATION POWER TRANSISTOR**
**Description**

This Bipolar Junction Transistor (BJT) is designed to meet the stringent requirements of automotive applications.

**Features**

- $BV_{CEO} > 60V$
- $I_C = 3A$  High Continuous Collector Current
- $I_{CM}$  up to 6A Peak Pulse Current
- 2W Power Dissipation
- Low Saturation Voltage  $V_{CE(SAT)} < 300mV @ 1A$
- Complementary PNP Type: DXT751Q
- **Totally Lead-Free & Fully RoHS Compliant (Notes 1 & 2)**
- **Halogen and Antimony Free. "Green" Device (Note 3)**
- **Qualified to AEC-Q101 Standards for High Reliability**
- **PPAP Capable (Note 4)**

**Mechanical Data**

- Case: SOT89
- Case Material: Molded Plastic. "Green" Molding Compound. UL Flammability Rating 94V-0
- Moisture Sensitivity: Level 1 per J-STD-020
- Terminals: Finish - Matte Tin Plated Leads, Solderable per MIL-STD-202, Method 208
- Weight: 0.052 grams (Approximate)

**Applications**

- Load Management Functions
- Motor Control
- DC-DC / DC-AC Converters



Top View

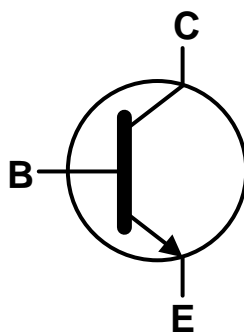

Device Symbol

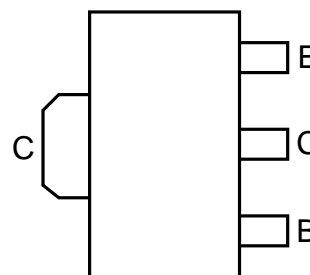

Top View Pinout

**Ordering Information** (Notes 4 and 5)

Product	Compliance	Marking	Reel Size (inches)	Tape Width (mm)	Quantity Per Reel
DXT651Q-13	Automotive	KN2	13	12	2,500

- Notes:
1. No purposely added lead. Fully EU Directive 2002/95/EC (RoHS) & 2011/65/EU (RoHS 2) compliant.
  2. See [http://www.diodes.com/quality/lead\\_free.html](http://www.diodes.com/quality/lead_free.html) for more information about Diodes Incorporated's definitions of Halogen- and Antimony-free, "Green" and Lead-free.
  3. Halogen- and Antimony-free "Green" products are defined as those which contain <900ppm bromine, <900ppm chlorine (<1500ppm total Br + Cl) and <1000ppm antimony compounds.
  4. Automotive products are AEC-Q101 qualified and are PPAP capable. Refer to [http://www.diodes.com/product\\_compliance\\_definitions.html](http://www.diodes.com/product_compliance_definitions.html).
  5. For packaging details, go to our website at <http://www.diodes.com/products/packages.html>.

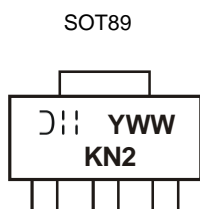
**Marking Information**

KN2 = Product Type Marking Code  
 DII = Manufacturer's Marking Code  
 YWW = Date Code Marking  
 Y = Last Digit of Year (ex: 6 = 2016)  
 WW = Week Code (01 to 53)

**Absolute Maximum Ratings** (@T<sub>A</sub> = +25°C, unless otherwise specified.)

Characteristic	Symbol	Value	Unit
Collector-Base Voltage	V <sub>CBO</sub>	80	V
Collector-Emitter Voltage	V <sub>CEO</sub>	60	V
Emitter-Base Voltage	V <sub>EBO</sub>	5	V
Collector Current	I <sub>C</sub>	3	A
Peak Pulse Collector Current	I <sub>CM</sub>	6	A
Peak Base Current	I <sub>B</sub>	500	mA

**Thermal Characteristics** (@T<sub>A</sub> = +25°C, unless otherwise specified.)

Characteristic	Symbol	Value	Unit
Power Dissipation	P <sub>D</sub>	(Note 6)	1
		(Note 7)	2
Thermal Resistance, Junction to Ambient Air	R <sub>θJA</sub>	(Note 6)	125
		(Note 7)	62.5
Thermal Resistance, Junction to Leads	R <sub>θJL</sub>	6.0	°C/W
Operating and Storage Temperature Range	T <sub>J</sub> , T <sub>STG</sub>	-55 to +150	°C

- Notes:
6. For a device surface mounted on 15mm x 15mm x 0.6mm FR-4 PCB with high coverage of single sided 1 oz copper, in still air conditions; the device is measured when operating in steady state condition.
  7. Same as note 6, except the device is mounted on 40mm x 40mm x 1.6mm FR-4 PCB.
  8. Thermal resistance from junction to solder-point (on the exposed collector pad).

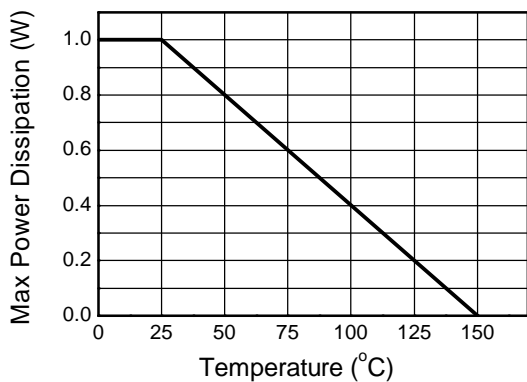
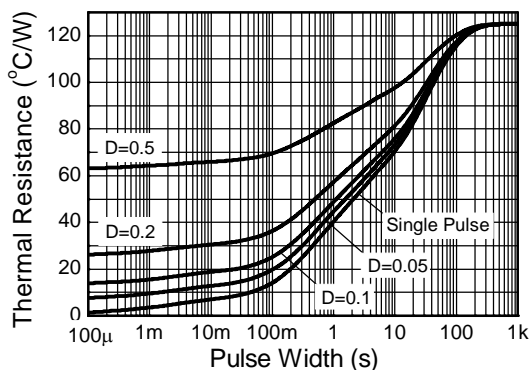
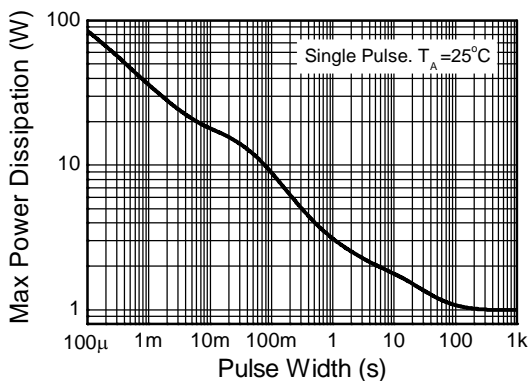
**Thermal Characteristics and Derating Information**

**Derating Curve**

**Transient Thermal Impedance**

**Pulse Power Dissipation**

**Electrical Characteristics** (@ $T_A = +25^\circ\text{C}$ , unless otherwise specified.)

Characteristic	Symbol	Min	Typ	Max	Unit	Test Conditions
<b>OFF CHARACTERISTICS</b>						
Collector-Base Breakdown Voltage	$BV_{CBO}$	80	—	—	V	$I_C = 100\mu\text{A}$
Collector-Emitter Breakdown Voltage (Note 9)	$BV_{CEO}$	60	—	—	V	$I_C = 10\text{mA}$
Emitter-Base Breakdown Voltage	$BV_{EBO}$	5	—	—	V	$I_E = 100\mu\text{A}$
Collector-Base Cutoff Current	$I_{CBO}$	—	—	0.1 10	$\mu\text{A}$	$V_{CB} = 60\text{V}$ $V_{CB} = 60\text{V}, T_A = +100^\circ\text{C}$
Emitter-Base Cutoff Current	$I_{EBO}$	—	—	0.1	$\mu\text{A}$	$V_{EB} = 4\text{V}$
<b>ON CHARACTERISTICS (Note 9)</b>						
Collector-Emitter Saturation Voltage	$V_{CE(SAT)}$	—	0.08 0.23	0.3 0.6	V	$I_C = 1\text{A}, I_B = 100\text{mA}$ $I_C = 3\text{A}, I_B = 300\text{mA}$
Base-Emitter Saturation Voltage	$V_{BE(SAT)}$	—	0.85	1.25	V	$I_C = 1\text{A}, I_B = 100\text{mA}$
Base-Emitter Turn-On Voltage	$V_{BE(ON)}$	—	0.8	1	V	$V_{CE} = 2\text{V}, I_C = 1\text{A}$
DC Current Gain	$h_{FE}$	70 100 80 40	200 200 185 120	— 300 — —	—	$V_{CE} = 2\text{V}, I_C = 50\text{mA}$ $V_{CE} = 2\text{V}, I_C = 500\text{mA}$ $V_{CE} = 2\text{V}, I_C = 1\text{A}$ $V_{CE} = 2\text{V}, I_C = 2\text{A}$
<b>SMALL-SIGNAL CHARACTERISTICS</b>						
Transition Frequency	$f_T$	140	200	—	MHz	$V_{CE} = 5\text{V}, I_C = 100\text{mA}, f = 100\text{MHz}$
Output Capacitance	$C_{obo}$	—	—	30	pF	$V_{CB} = 10\text{V}, f = 1\text{MHz}$
Switching Times	$t_{ON}$ $t_{OFF}$	— —	35 230	— —	ns ns	$V_{CC} = 10\text{V}, I_C = 500\text{mA}, I_{B1} = -I_{B2} = 50\text{mA}$

Note: 9. Measured under pulsed conditions. Pulse width  $\leq 300\mu\text{s}$ . Duty cycle  $\leq 2\%$ .

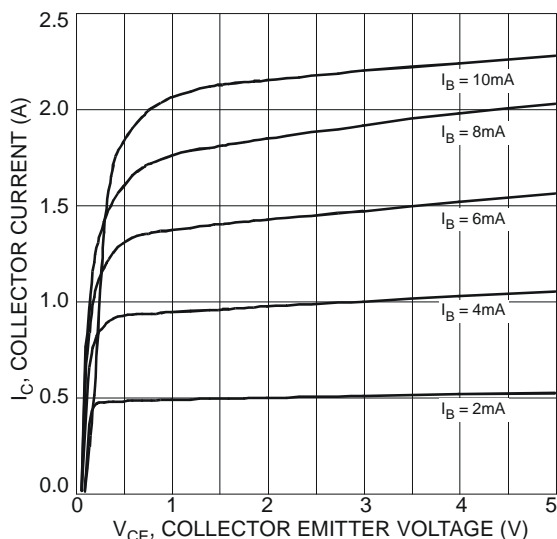

Figure 1 Typical Collector Current vs. Collector-Emitter Voltage

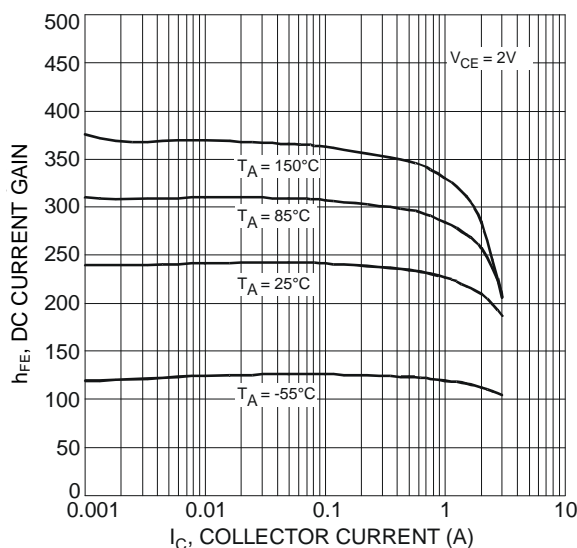

Figure 2 Typical DC Current Gain vs. Collector Current

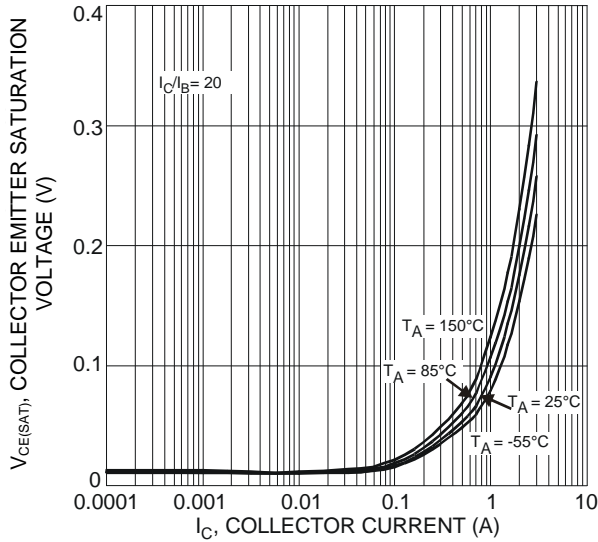

Figure 3 Typical Collector-Emitter Saturation Voltage vs. Collector Current

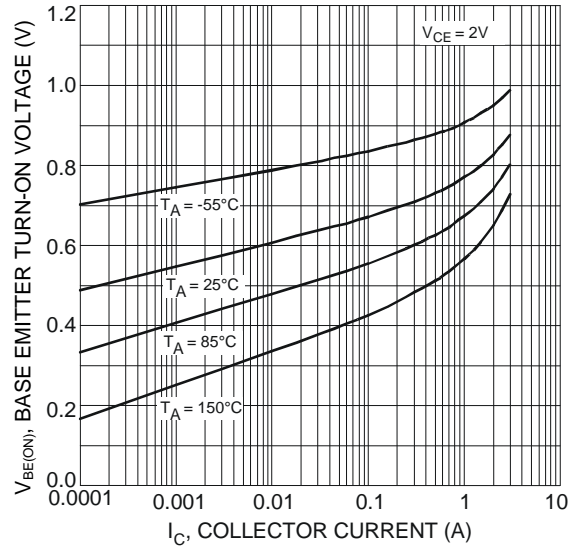

Figure 4 Typical Base-Emitter Turn-On Voltage vs. Collector Current

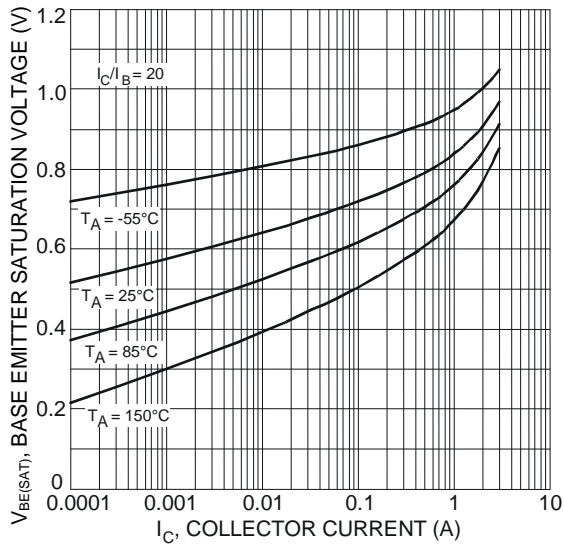

Figure 5 Typical Base-Emitter Saturation Voltage vs. Collector Current

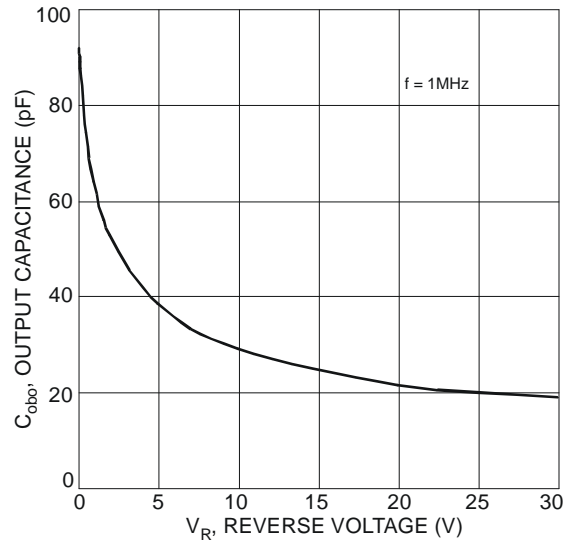

Figure 6 Typical Output Capacitance Characteristics

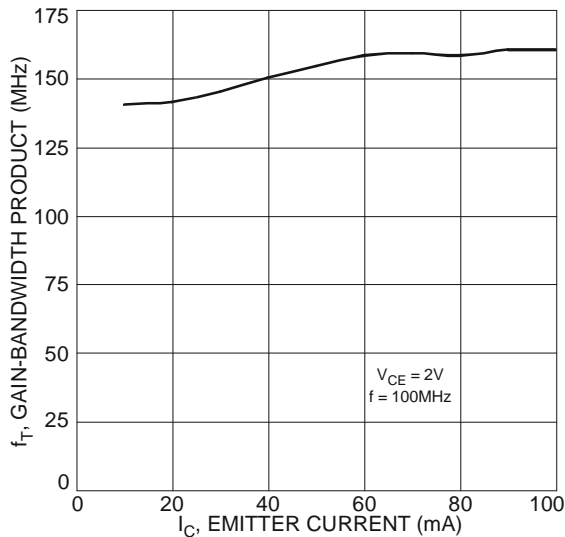
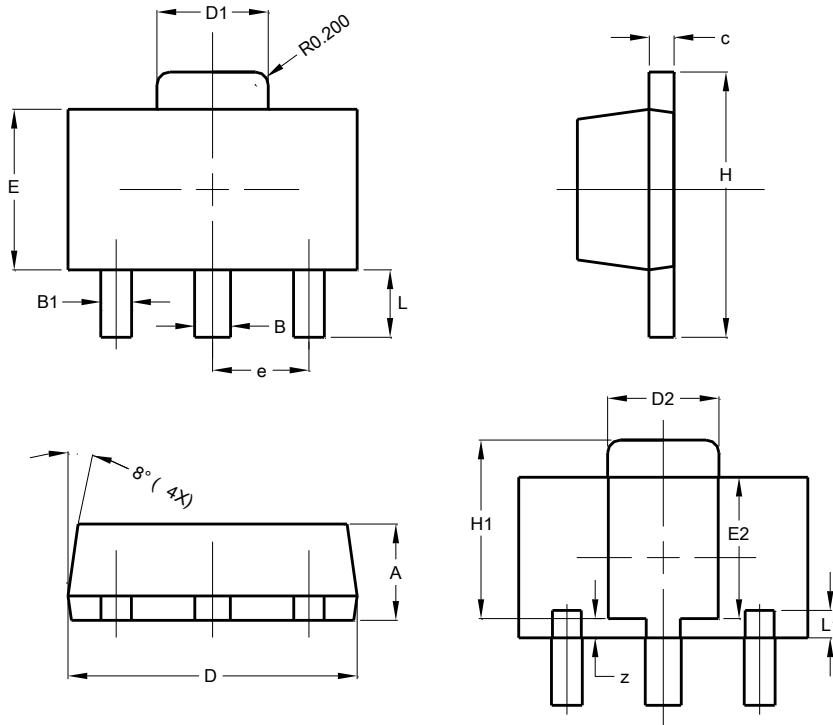

Figure 7 Typical Gain-Bandwidth Product vs. Emitter Current

**Package Outline Dimensions**

Please see <http://www.diodes.com/package-outlines.html> for the latest version.



SOT89			
Dim	Min	Max	Typ
A	1.40	1.60	1.50
B	0.50	0.62	0.56
B1	0.42	0.54	0.48
c	0.35	0.43	0.38
D	4.40	4.60	4.50
D1	1.62	1.83	1.733
D2	1.61	1.81	1.71
E	2.40	2.60	2.50
E2	2.05	2.35	2.20
e	-	-	1.50
H	3.95	4.25	4.10
H1	2.63	2.93	2.78
L	0.90	1.20	1.05
L1	0.327	0.527	0.427
z	0.20	0.40	0.30
<b>All Dimensions in mm</b>			

**Suggested Pad Layout**

Please see <http://www.diodes.com/package-outlines.html> for the latest version.

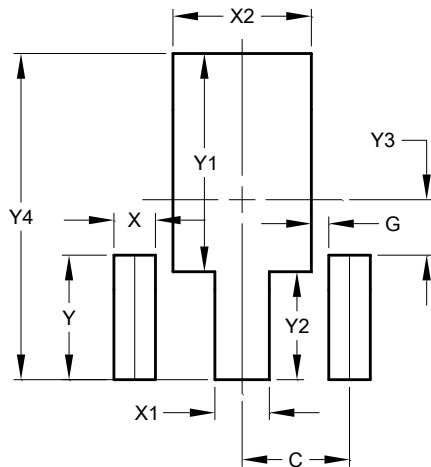

Dimensions	Value (in mm)
C	1.500
G	0.244
X	0.580
X1	0.760
X2	1.933
Y	1.730
Y1	3.030
Y2	1.500
Y3	0.770
Y4	4.530

**IMPORTANT NOTICE**

DIODES INCORPORATED MAKES NO WARRANTY OF ANY KIND, EXPRESS OR IMPLIED, WITH REGARDS TO THIS DOCUMENT, INCLUDING, BUT NOT LIMITED TO, THE IMPLIED WARRANTIES OF MERCHANTABILITY AND FITNESS FOR A PARTICULAR PURPOSE (AND THEIR EQUIVALENTS UNDER THE LAWS OF ANY JURISDICTION).

Diodes Incorporated and its subsidiaries reserve the right to make modifications, enhancements, improvements, corrections or other changes without further notice to this document and any product described herein. Diodes Incorporated does not assume any liability arising out of the application or use of this document or any product described herein; neither does Diodes Incorporated convey any license under its patent or trademark rights, nor the rights of others. Any Customer or user of this document or products described herein in such applications shall assume all risks of such use and will agree to hold Diodes Incorporated and all the companies whose products are represented on Diodes Incorporated website, harmless against all damages.

Diodes Incorporated does not warrant or accept any liability whatsoever in respect of any products purchased through unauthorized sales channel. Should Customers purchase or use Diodes Incorporated products for any unintended or unauthorized application, Customers shall indemnify and hold Diodes Incorporated and its representatives harmless against all claims, damages, expenses, and attorney fees arising out of, directly or indirectly, any claim of personal injury or death associated with such unintended or unauthorized application.

Products described herein may be covered by one or more United States, international or foreign patents pending. Product names and markings noted herein may also be covered by one or more United States, international or foreign trademarks.

This document is written in English but may be translated into multiple languages for reference. Only the English version of this document is the final and determinative format released by Diodes Incorporated.

**LIFE SUPPORT**

Diodes Incorporated products are specifically not authorized for use as critical components in life support devices or systems without the express written approval of the Chief Executive Officer of Diodes Incorporated. As used herein:

A. Life support devices or systems are devices or systems which:

1. are intended to implant into the body, or
2. support or sustain life and whose failure to perform when properly used in accordance with instructions for use provided in the labeling can be reasonably expected to result in significant injury to the user.

B. A critical component is any component in a life support device or system whose failure to perform can be reasonably expected to cause the failure of the life support device or to affect its safety or effectiveness.

Customers represent that they have all necessary expertise in the safety and regulatory ramifications of their life support devices or systems, and acknowledge and agree that they are solely responsible for all legal, regulatory and safety-related requirements concerning their products and any use of Diodes Incorporated products in such safety-critical, life support devices or systems, notwithstanding any devices- or systems-related information or support that may be provided by Diodes Incorporated. Further, Customers must fully indemnify Diodes Incorporated and its representatives against any damages arising out of the use of Diodes Incorporated products in such safety-critical, life support devices or systems.

Copyright © 2016, Diodes Incorporated

**www.diodes.com**

# Mouser Electronics

Authorized Distributor

Click to View Pricing, Inventory, Delivery & Lifecycle Information:

[Diodes Incorporated:](#)

[DXT651Q-13](#)