

RoHS

| REV. | EC# | DESCRIPTION | DATE | DRAWING | CHECKED | APPROVED |
|------|-----|-------------|------|---------|---------|----------|
| A0   |     |             |      |         |         |          |

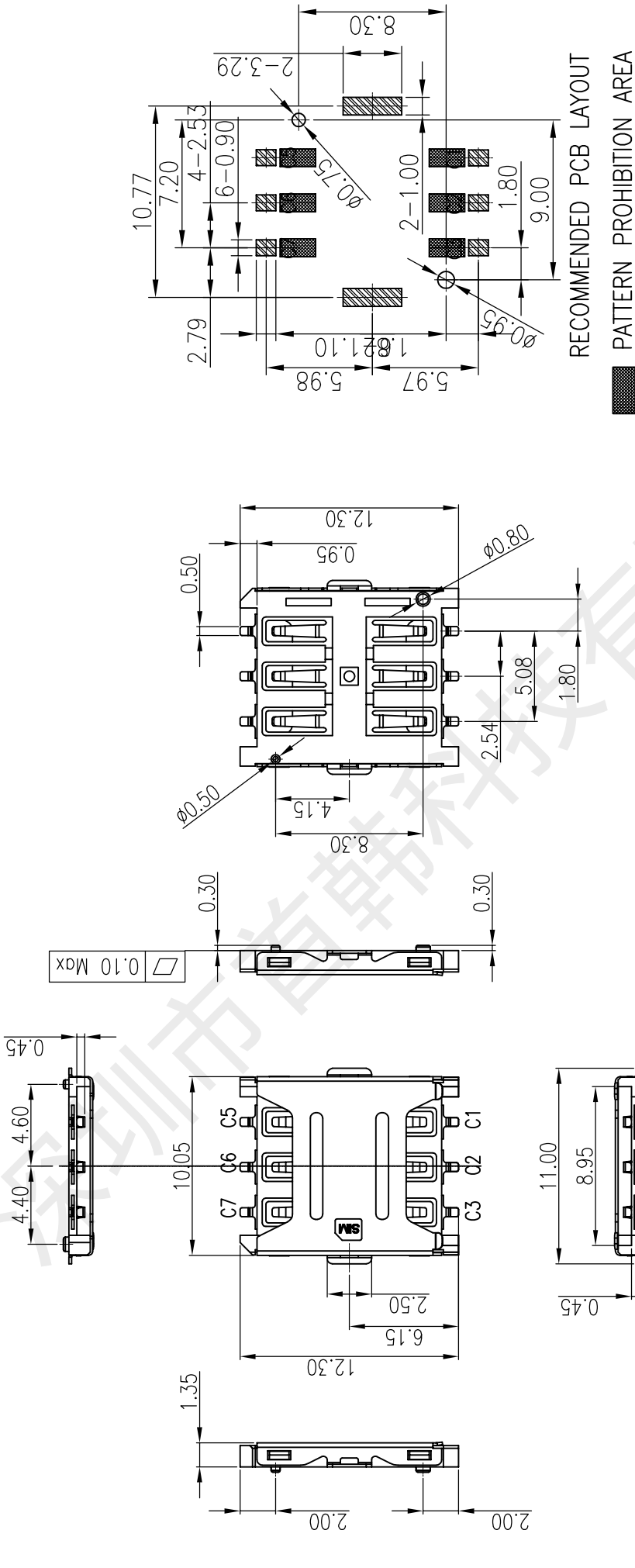

- NOTES:**
- MATERIAL:**
    - 1.1 Insulator: High Temperature Thermoplastic, UL94V-0; Color: Black.
    - 1.2 Terminal: Copper Alloy.
    - 1.3 Shell: Stainless Steel.
  - PLATING:**
    - 2.1 Contact: Plated 50μ" Ni Overall Contact Au 1μ"
    - 2.2 Shell: Plated 50μ" Ni Overall, PAD Au 1μ"
  - SPECIALTY:**
    - 2.1 Current Rating :0.5mA AC/DC max.
    - 2.2 Voltage Rating :125V AC/DC
    - 2.3 Ambient Temperature Range : -20° C~+60° C
    - 2.4 Storage Temperature Range : -40° C~+70° C
    - 2.5 Ambient Humidity Range :95% R. H. Max.
    - 2.6 Contact Resistance:100mΩ max.
    - 2.7 Insulation Resistance:100MΩ min./500VDC
    - 2.8 Mating Cycles:10,000 Insertions
    - 2.9 Reflow peak temp : 260° C ±5° C, 3" S
    - 2.10 Mating Cycles:3,000 Insertions Min
  - PLEASE CONTACT IQ SALES REPRESENTATIVE TO VERIFY PRODUCT DETAILS & AVAILABILITY**

| SIM pin assignment |         |
|--------------------|---------|
| PIN#               | Name    |
| C1                 | VCC供电电压 |
| C2                 | RST重置   |
| C3                 | CLK时钟   |
| C5                 | GND接地   |
| C6                 | VPP程序电压 |
| C7                 | I/O输入输出 |

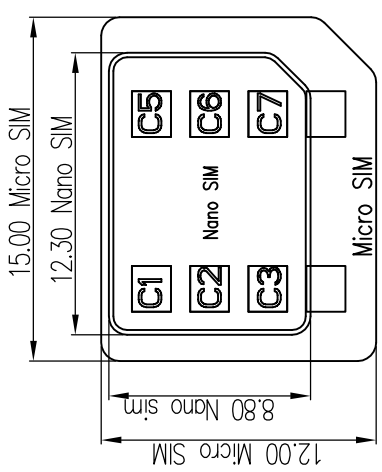

**深圳市首韩科技有限公司**

**DRAW NAME:**  
SIM 卡座

**P/N :** NANO SIM TL6P H1.35

|   |       |       |          |          |            |
|---|-------|-------|----------|----------|------------|
| Unless otherwise specified tolerances are | XX    | ±0.30 | DRAW NO. | DATE     | DRAW NAME: |
|   | XXX   | ±0.20 | DWN      | 19-11-25 | SIM 卡座     |
|   | X'XXX | ±0.10 | CHK      | 19-11-25 |            |
| X'  | ±3.0' |       | APVD     | 19-11-25 |            |
| X'X'                                      | ±1.5' |       |          |          |            |

|                     |                 |      |       |        |     |        |
|---------------------|-----------------|------|-------|--------|-----|--------|
| FINISH              |                 | UNIT | SCALE | WEIGHT | REV | SHEET  |
| Third Angle Project |                 | mm   | 1:1   |        | A0  | 1 OF 2 |
| DWG NO.             | C-1070025110-00 |      |       |        |     |        |



深圳市首韩科技有限公司

SHENZHEN SHOUHAN TECHNOLOGY CO., LTD

Tel: 0755-27597601 Fax: 0755-27597491

# 承 认 书

## SPECIFICATION FOR APPROVAL

商品编码 Part Code:

\_\_\_\_\_

产品名称 Project:

SIM卡座

规格型号 Part No:

NANO SIM TL6P H1.35

### 贵公司承认印 Approval signatures

| 料号/Part No. | 签章/Signatures |
|-------------|---------------|
|             |               |

日期 Date:

|             |     |  |
|-------------|-----|--|
| 拟制/Drawn    | 李春风 |  |
| 审核/Check    | 钟华华 |  |
| 批准/Approved | 罗孝金 |  |

|   |                            |             |                 |
|---|----------------------------|-------------|-----------------|
|  | <b>Product Name</b>        | <b>Rev.</b> | <b>Page No.</b> |
|   | <b>NANO SIM TL6P H1.35</b> | <b>A/0</b>  | 1 / 8           |

|   |   |
|---|---|
| 1; SCOPE (适用范围) .....                                     | 3 |
| 2; REFERENCE DOCUMENTS (参考文件) .....                       | 3 |
| 3; FEATURE & DIMENSIONS (特征及尺寸) .....                     | 3 |
| 3.1. PRODUCT DIMENSION (产品尺寸) .....                       | 3 |
| 3.2. PCB/PANEL LAYOUT (印刷电路板布局) .....                     | 3 |
| 3.3. MATERIAL (材料) .....                                  | 3 |
| 3.4. MECHANICAL & ELECTRICAL CHARACTERISTIC (机械及电气特性) ... | 3 |
| 3.5. PACKAGING (包装) .....                                 | 3 |
| 3.6. MARKING (标识) .....                                   | 3 |
| 3.7. TRANSPORTATION (运输) .....                            | 3 |
| 3.8. STORAGE (存贮) .....                                   | 4 |
| 4. ENVIRONMENTAL (环境要求) .....                             | 4 |
| 4.1. SOLDERABILITY (可焊性) .....                            | 4 |
| 4.2. RESISTANCE TO SOLDER HEAT (耐焊接热) .....               | 4 |
| 4.2.1. Wave Soldering (波峰焊) .....                         | 4 |
| 4.2.1.1. Preheat (预热) .....                               | 4 |
| 4.2.1.2. Soldering (焊接) .....                             | 4 |
| 4.2.1.3. Cool Down (冷却) .....                             | 4 |
| 4.2.2. INFRARED REFLOW (红外线回流焊) .....                     | 4 |
| 4.2.2.1. Preheat (预热) .....                               | 4 |
| 4.2.2.2. Soldering (焊接) .....                             | 4 |
| 4.2.2.3. Cool Down (冷却) .....                             | 4 |
| 4.3. CLEANING (清洗) .....                                  | 4 |
| 5. PERFORMANCE AND TEST DESCRIPTION (性能及测试) .....         | 5 |
| 5.1. REQUIREMENT (要求) .....                               | 5 |
| 5.2. TEST CONDITION (测试条件) .....                          | 5 |
| 5.3. SAMPLE SELECTION (样品选择) .....                        | 5 |
| 5.4. TEST SEQUENCE (测试顺序) .....                           | 5 |
| 6. QUALITY ASSURANCE PROVISIONS (品质保证) .....              | 5 |
| TABLE I: PERFORMANCE REQUIREMENTS .....                   | 6 |
| TABLE II: PRODUCT QUALIFICATION TEST SEQUENCE .....       | 8 |
| TABLE III: REFLOW SOLDERING PROFILE .....                 | 9 |

|   |                            |             |                 |
|---|----------------------------|-------------|-----------------|
|  | <b>Product Name</b>        | <b>Rev.</b> | <b>Page No.</b> |
|   | <b>NANO SIM TL6P H1.35</b> | <b>A/0</b>  | 2 / 8           |

## 1. SCOPE (适用范围)

This product specification specifies the characteristics and test methods of the connector products designed and manufactured by the Company.

本产品规格书规定了由本公司设计生产的连接器产品的特性及测试方法。

## 2. REFERENCE DOCUMENTS (参考文件)

**MIL-STD-1344A** Test method for electrical connector (电子连接器测试方法)

**MIL-STD-202F** Test method for electrical components (电子零件测试方法)

**EIA364** Test method for electrical components (电子零件测试方法)

**JIS C 0051** Test method for electrical components (电子零件测试方法)

**MIL-G-45204C** Specification for gold plating (镀金规格)

**IEC-512-3** IEC standard for current carrying capacity tests (IEC电流测试标准)

**QQ-N-290A** Specification for nickel plating (镀镍规格)

**MIL-P-81728A** Specification for tin/lead plating (镀锡铅规格)

**MIL-T-10727B** Specification for tin plating (镀锡规格)

**UL498** UL standard for safety of attachment plug and receptacle (UL安规要求标准)

**EN/ISO5961** Determination of total lead & cadmium content (总铅和总镉含量测定)

**EN1122** Determination of total lead & cadmium content (总铅和总镉含量测定)

**EN13346** Determination of heavy metals content (重金属含量测定)

**EPA3052** Determination of total lead & cadmium content (总铅和总镉含量测定)

## 3. FEATURE & DIMENSIONS (特征及尺寸)

### 3.1. PRODUCT DIMENSION (产品尺寸)

These connectors shall have the dimensions as shown in customer drawing.

本产品的相关尺寸参见客户图面。

### 3.2. PCB/PANEL LAYOUT (印刷电路板布局)

The recommended PCB layout is shown in customer drawing.

本产品适用的PCB layout参见客户图面。

### 3.3. MATERIAL (材料)

The harmful material can follow the requirement of RoHS.

本产品使用的材料符合 RoHS 指令要求。

### 3.4. MECHANICAL & ELECTRICAL CHARACTERISTIC (机械及电气特性)

The connector shall have the mechanical and electrical performance as described in table I:

本产品的机械及电气特性见附表I。

### 3.5. PACKAGING (包装)

Products shall be packaged according to requirements specified in purchase order for safe delivery. Products required tray or carrier tape should meet the proper specification per purchase order. Connector container and the packaging specification is shown in customer drawing.

产品包装可依客户指定要求。本产品采用卷带包装，具体规格见客户图面。

### 3.6. MARKING (标识)

Manufacturer's name, industry recognized logo, or customer approved marks.

标示制造商的名称，或客户认可的相关标志。

### 3.7. TRANSPORTATION (运输)

Any vehicle can be adopted for the transportation, but moisture-proof and no mechanical damage.

可采用任何运输工具运输，勿淋湿及机械性损伤。

|   |                            |             |                 |
|---|----------------------------|-------------|-----------------|
|  | <b>Product Name</b>        | <b>Rev.</b> | <b>Page No.</b> |
|   | <b>NANO SIM TL6P H1.35</b> | <b>A/0</b>  | 3 / 8           |

### 3.8. STORAGE (存贮)

Temperature: -40°C~+70°C, Relative humidity: ≤80%, Not to storage in corrosive environments A re-qualification test shall be conducted immediately while the storage duration exceed 6 months.

温度: -40°C~+70°C; 相对湿度: ≤80%; 勿贮存于腐蚀环境内。贮存期超过6个月后需重新进行品质确认。

## 4. ENVIRONMENTAL (环境要求)

### 4.1. SOLDERABILITY (可焊性)

Connector's solderability can meet MIL-STD-202F standard. Finish shall be free of contaminants.

产品可焊性符合 MIL-STD-202F 标准规定的相关要求, 表面不得有污染物。

### 4.2. RESISTANCE TO SOLDER HEAT (耐焊接热)

#### 4.2.1. Wave Soldering (波峰焊)

Consists of three consecutive phases. 包括三个连续的阶段完成;

##### 4.2.1.1. Preheat (预热)

Increase in temperature not to exceed 4°C per second. Final preheat temperature will be within 125°C of solder temperature. 温度增加不超过4°C /秒, 最终预热温度不超过125°C.

##### 4.2.1.2. Soldering (焊接)

Device leads will be exposed to solder wave at 250°C for a maximum of 5 seconds. 设备中的引导焊接温度最高250°C不超过5秒。

##### 4.2.1.3. Cool Down (冷却)

Cool down in ambient air at approximately 20°C to 25°C. 冷却到周围环境温度20°C~25°C.

#### 4.2.2. INFRARED REFLOW (红外线回流焊)

Three cycles. Each cycle consisting of three consecutive phased. 三个周期, 每个周期包括三个连续的阶段完成;

##### 4.2.2.1. Preheat (预热)

Increase in temperature not to exceed 4°C per second. 温度增加不超过4°C /秒,

##### 4.2.2.2. Soldering (焊接)

Maximum allowable time above reflow temperature of 183 °C is 90 seconds. Maximum temperature in this interval is 260°C, not to exceed 10 seconds. 回流焊温度183°C以上的时最长不超过 90秒. 最高温度260°C时间不超过10秒。

##### 4.2.2.3. Cool Down (冷却)

Cool down shall not exceed 6°C per second. 冷却速度不超过6°C/秒. **Note:** (注) Device temperature measurements are referenced from the top-center of the package outer surface. 设备温度量测时以从顶部中间位置测量为准;

### 4.3. CLEANING (清洗)

Connectors resist to cleaning process. Aqueous Cleaning: Three cycles; each cycle consisting of a maximum of one minute exposure to 54°C to 66°C demineralized tap water at a maximum pressure of 30 psi; followed by air drying for 60°C to 90 seconds at 93°C to 121°C.

产品本身可以承受清洗制程. 水洗: 包含三个循环; 每个循环包括以下: 以最大压力30帕, 温度 54°C~66°C, 去除矿物质的水, 用水龙头冲洗最多一分钟, 然后用温度 93°C~121°C的空气吹60到90秒;

|   |                            |             |                 |
|---|----------------------------|-------------|-----------------|
|  | <b>Product Name</b>        | <b>Rev.</b> | <b>Page No.</b> |
|   | <b>NANO SIM TL6P H1.35</b> | <b>A/0</b>  | <b>4 / 8</b>    |

## 5. PERFORMANCE AND TEST DESCRIPTION (性能及测试)

### 5.1. REQUIREMENT (要求)

Product is designed to meet electrical, mechanical, and environmental performance requirements specified in **Table I**.

本产品设计符合附表一所述的机械，电气及环境要求。

### 5.2. TEST CONDITION (测试条件)

Unless otherwise specified, all tests shall be performed at ambient environmental conditions.

除非特别说明，所有测试在室温条件下完成；

### 5.3. SAMPLE SELECTION (样品选择)

Test samples shall be selected at random from current production. No test samples shall be reused. Samples are pre-conditioned with 10cycles of durability. Each group shall be containing 5 test samples.

测试样品从现生产的产品中随机抽取，所有测试过的样品不得重复使用。样品已预先插拔10次，每组测试有5个样品；

### 5.4. TEST SEQUENCE (测试顺序)

Products qualification test sequence as shown in **Table II**.

产品品质测试顺序见附表二。

## 6. QUALITY ASSURANCE PROVISIONS (品质保证)

Company is responsible for the quality of the part as it is delivered to customer. Failing lots will be return or other supplier corrective action.

本公司对出给客户的所有产品品质负责，不良批次的产品退回或由供应商做矫正；

|   |                            |             |                 |
|---|----------------------------|-------------|-----------------|
|  | <b>Product Name</b>        | <b>Rev.</b> | <b>Page No.</b> |
|   | <b>NANO SIM TL6P H1.35</b> | <b>A/0</b>  | 5 / 8           |

**TABLE I: PERFORMANCE REQUIREMENTS**

| <b>Items</b>                                 | <b>Requirements</b>   | <b>Test Methods</b>   |
|--|---|---|
| 1. Confirmation of Product 产品确认              | Product shall be conforming to the requirements of applicable product drawing.<br>产品必须满足相关文件的规定   | Visually, dimensions and functionally inspected per applicable product drawing.<br>目视, 尺寸及功能依照客户图面检查。   |
| 2. Contact resistance (Low Level) 接触阻抗       | 100 m $\Omega$ Max. initial<br>100 m $\Omega$ 最大.初态   | Subject mated contacts assembled in housing to closed circuit of 10 mA max. at open circuit voltage of 20 mV max. 所述固定在外壳里的端子联结到一个封闭回路中测试: 电流10mA, 电压20 mV max.。  |
| 3. Insulation resistance 绝缘阻抗                | 1000 M $\Omega$ Min. 1000 M $\Omega$ 最小   | Measure by applying test potential between the adjacent contacts, and between the contacts and ground in the mated connector. MIL-STD-202, Method 302, Condition B (500 V DC $\pm$ 10%). 测试产品端子间以及端子与接地间的电阻, 适用: MIL-STD-202, 方法302, 条件B (500V DC $\pm$ 10%)。                   |
| 4. Dielectric Strength 耐电压                   | Connector must withstand test potential of 500 V AC for 1 minute. Current leakage must be 1.0 mA max.. 样品必须承受测试电 500V AC, 时间一分钟, 漏电流不大于1.0 mA.  | Measure by applying test potential between the adjacent contacts, and between the contacts and ground in the mated connector. MIL-STD-202, Method 301. 测试产品端子间以及端子与接地间的电压, 适用: MIL-STD-202, 方法 301。   |
| 5. Durability (Repeated Mating/Unmating) 耐久力 | Contact Resistance: <b>100 m<math>\Omega</math></b> Max. after testing 完成插拔测试后接触阻抗不大于100 m $\Omega$   | Mate and unmate connector for 3000 cycle . 同配合产品进行3000次插拔。  |
| 6. Temperature rise 温度急变                     | 30 $^{\circ}$ C Max. 不高于30 $^{\circ}$ C   | Carry rated current load.0.3A per contact. (UL498) 每根端子负载0.3A 电流。(UL498)  |
| 7. Vibration Sinusoidal Low Frequency 低频正弦振动 | No electrical discontinuity greater then 1 $\mu$ sec (s) shall occur. Contact resistance: <b>100 m<math>\Omega</math></b> max. 不允许出现超过1 $\mu$ sec (s) 的瞬间断开, 接触阻抗: 100 m $\Omega$ 最大; | Subject mated connector to 10-55-10 Hz traversed in 1 minute at 1.5 mm amplitude 2 hours each of 3 mutually perpendicular plane, 10 mA applied MIL-STD-202, Method 201. 对测试样品, 在频率变化每分钟从10-55-10 Hz, 振幅 1.5 mm 条件下, 在互相垂直的三个面上, 每个面2 小时下测量, 电流 10 mA ; 适用: MIL-STD-202, 方法 201。 |
| 8. Shock 冲击                                  | No electrical discontinuity greater than 1 $\mu$ sec. shall occur. No damage to product. 不允许出现超过1 $\mu$ sec (s) 的瞬间断开, 产品无损坏;   | Applying an appropriate holder is allowed in vibration test and shock test. MIL-STD-202, Method 213, 490m/s $^2$ . 3 axes. 使用合适的固定方式, 适用方法. MIL-STD -202, 方法213, 加速度490m/s $^2$ , 三个轴上均做测试。   |

|   |                            |             |                 |
|---|----------------------------|-------------|-----------------|
|  | <b>Product Name</b>        | <b>Rev.</b> | <b>Page No.</b> |
|   | <b>NANO SIM TL6P H1.35</b> | <b>A/0</b>  | 6 / 8           |

| Items                                | Requirements  | Test Methods   |
|--------------------------------------|---|--|
| 9. Thermal shock 热冲击                 | No damage, Contact Resistance (Low Level) (Final) <b>100 m<math>\Omega</math> max.</b> 产品无损坏, 接触阻抗: 100 m $\Omega$ 最大   | Temperature range from -55°C to +85°C .Start from -55°C. After 30 min. change to +85°C, change time is no more than 30 seconds. Total 5 cycles. MIL-STD-202, Method 107D,condition A. 温度变化范围: -55°C~+85°C ; 从 -55°C 开始, 30 分钟后换到 +85°C ; 转换时间不超过30 秒; 共5 个循环。适用: MIL-STD-202 , 方法107D , 条件A。 |
| 10. Humidity 恒温恒湿                    | No damage, Contact Resistance (Low Level) (Final) <b>100 m<math>\Omega</math> max.</b> Dielectric Strength should be OK, Insulation Resistance should be 100 M $\Omega$ min. 产品无损坏, 接触阻抗: 100 m $\Omega$ 最大; 耐压测试OK, 绝缘阻抗100M $\Omega$ 最小;          | Temperature :40 $\pm$ 2° C 96 hours. Relative humidity: 90-95%; Duration: 96 Hours. MIL-STD-202, Method 103, 温度: 40 $\pm$ 2° C 96 小时; 相对湿度: 90-95% ; 时间: 96 小时; MIL-STD-202 , 方法103。   |
| 11.Solderability 可焊性                 | Appearance of the specimen shall be inspected after the test with the assistance of a magnifier capable of giving a magnification of 10 X for any damage such as pinholes, void or rough surface. 样品在测试完成后, 用放大倍数为10 倍的显微镜, 检查外观损坏如: 小孔, 空焊, 外观粗糙度; | Soldering time: 3 to 5 Seconds Temperature: 255 $\pm$ 5°C. 焊接时间: 3~5 秒, 温度: 255 $\pm$ 5°C。   |
| 12.Resistance to soldering heat 耐焊接热 | No damage 产品无损坏   | Leave subject product in the 255 $\pm$ 5°C chamber for 2 minutes. 产品置于255 $\pm$ 5°C 烘箱内2 分钟。   |
| 13. Salt Spray 盐雾                    | Contact Resistance (Low Level) (Final) <b>100 m<math>\Omega</math> max.</b> 接触阻抗(末态) 100 m $\Omega$ max.  | 5 $\pm$ 1% salt concentration 24 $\pm$ 4 hours 35 $\pm$ 2°C MIL-STD-202, Method 101 Condition B. 盐水浓度 (重量比) 5 $\pm$ 1%, 镀金区域时间24 小时, 镀锡区域时间8小时。温度35 $\pm$ 2°C; MIL-STD-202, 方法101 , 条件B。   |
| 14.High temperature 高温               | Contact resistance: <b>100 m<math>\Omega</math> max.</b> 接触阻抗100 m $\Omega$ max.  | Subject product to 85 $\pm$ 2°C for 96 hours continuously. MIL-STD-202, Method 108. 产品置于85 $\pm$ 2°C 连续96 小时, 适用 MIL-STD-202, 方法108。   |



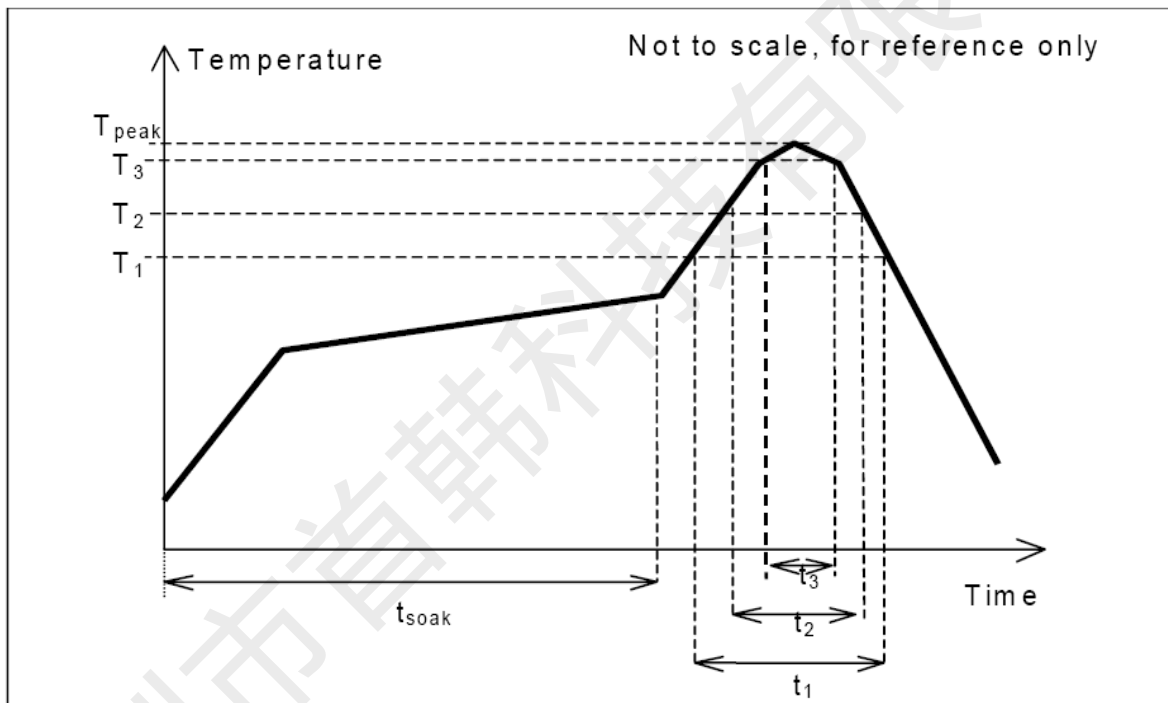

TABLE III:

REFLOW SOLDERING PROFILE

Pb-free reflow profile requirements:

| Parameter                                  | Reference         | Specification   |
|--|-------------------|-----------------|
| Average temperature gradient in preheating |                   | 2.5°C/s         |
| Soak time                                  | t <sub>soak</sub> | 2-3 minutes     |
| Time above 217°C                           | t <sub>1</sub>    | 60 s            |
| Time above 230°C                           | t <sub>2</sub>    | 50 s            |
| Time above 255°C                           | t <sub>3</sub>    | 5 s             |
| Peak temperature in reflow                 | T <sub>peak</sub> | 255°C (+5/-0°C) |
| Temperature gradient in cooling            |                   | Max -5°C/s      |



This profile is the minimum requirement for evaluating soldering heat resistance of components. Heat transfer method used for reflow soldering is hot air convection. The actual air temperatures used to achieve the specified profile is higher and largely dependent on the reflow equipment.