

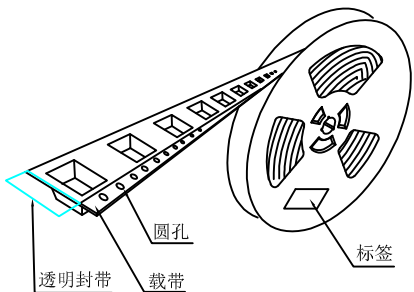

产品

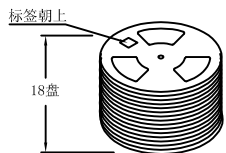

透明封带 载带



18盘

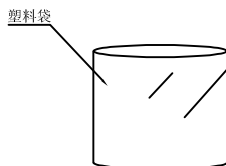

塑料袋

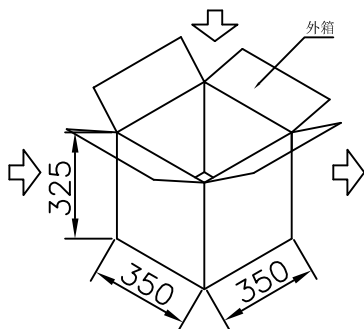

外箱

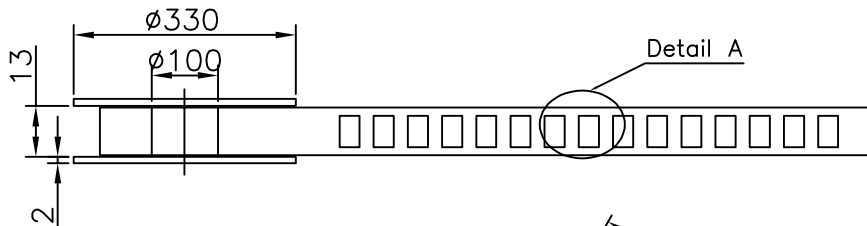
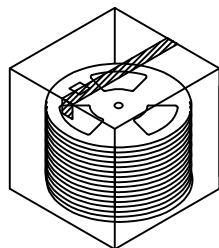

Detail A

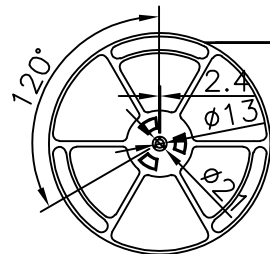

出料方向

剥离方向
余留封带长: 300 MIN
载带与封带剥离
剥离角度: 165°-180°
剥离强度: 0.1-1.0N

末端留空穴载带

共封装 10000 只产品

前端留空穴载带

$\phi 1.50^{+0.10}_{-0.00}$

2.00 ± 0.10

4.00 ± 0.10

12.00 ± 0.30

8.00 ± 0.10

5.50 ± 0.10

5.15 ± 0.10

$T = 0.30 \pm 0.05$

0.75 ± 0.10

工程部
2023-03-21
H. WANG

技术要求:

1. 圆孔十个孔距离累计允许公差为 $\pm 0.2\text{mm}$
2. 带长250mm内容许弯曲度1mm
3. 材料厚度以在载带边缘测量为准
4. 所有尺寸定义依循EIA-481-C系准则定义之
5. 材料:透明PS T=0.30 \pm 0.05mm
6. 所有卷轮为灰蓝挖空旋转塑胶卷轮
7. 整模成型长度:80.64M,
8. 非指明公差范围为: $\pm 0.1\text{mm}$;超过250mm不计算累计误差
9. 型腔外形凡未标明处倒角R为0.2-0.3; 拔模斜度未标注的为3° 以下

包装信息:

- 1、每卷盘装产品 10000 只, 卷盘外侧贴相关标签;
- 2、每 18 卷盘放在一个塑料袋中;
- 3、每外箱装18盘, 产品总数: 180000 只;
- 4、外箱上下用胶纸封成“工”字;

UNLESS OTHERWISE SPECIFIED TOLERANCES		MYOUNG 美阳 www.meiyangdz.com	
DECIMALS: X : ±*** X.X : ±*** X.XX : ±*** X.XXX : ±***	ANGLES: X : ±*** X.X : ±***	DSND YangFeng	DATE 2023-03-21
		CHKD ZhouRuicai	DATE 2023-03-21
		APVD XueShun Yong	DATE 2023-03-21
		SCALE:	VIEW:
		SIZE: A4	REV.: A/0
SHEET 1 OF 1		UNIT: mm	OBJECT: MY
		TITLE: 负极小圆片H0.2MM直径5MM 卷装	
		PART NO.: MY-FJ-131-J-R	
		DRAW NO.:MY-BD-0068	