



### FEATURES

- Available Output Voltage:8.0V
- Maximum Input Voltage:  
30V for  $V_{OUT} < 10V$
- Maximum Output Current:  
Exceed 100mA at  $T_J = 25^{\circ}C$
- Output Tolerances:  
 $\pm 3\%$  at  $T_J = 25^{\circ}C$   
 $\pm 5\%$  over the Operating  $T_J$
- No External Components

### Applications

- TV Board
- Air Conditioner
- Vehicle Mounted Radar
- Charging Device

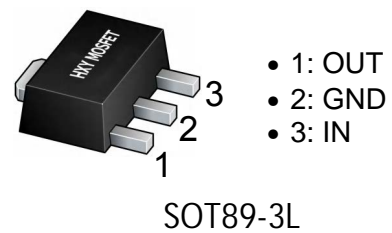

### Package Marking and Ordering Information

Product ID	Pack	Marking	Qty(PCS)
78L08	SOT89-3L	78L08	1000

### Typical Application Circuit

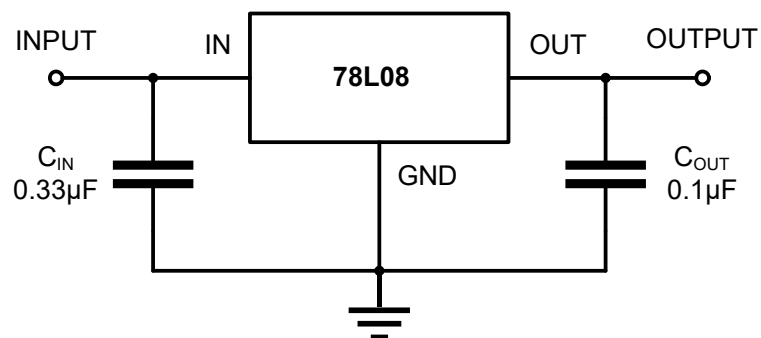



### Absolute Maximum Ratings

CHARACTERISTIC	SYMBOL	VALUE	UNIT
Maximum input voltage	$V_{IN}$	30	V
Maximum junction temperature	$T_{J Max}$	150	°C
Storage temperature	$T_{stg}$	- 65 ~ 150	°C
Soldering temperature & time	$T_{solder}$	260°C, 10s	-

### Electrical Characteristics

78L08 ( $V_{IN} = 14V$ ,  $I_{OUT} = 40mA$ ,  $C_{IN} = 0.33\mu F$ ,  $C_{OUT} = 0.1\mu F$ ,  $T_J = 25^\circ C$ , unless otherwise specified)

CHARACTERISTIC	SYMBOL	TEST CONDITIONS <sup>(6)</sup>	MIN.	TYP.	MAX.	UNIT
Input voltage	$V_{IN}$	-	-	-	30	V
Output voltage	$V_{OUT}$	$T_J = 25^\circ C$ $\pm 3\%$ grade	7.76	8.00	8.24	V
		$V_{IN} = 10.5$ to $23V$ , $I_{OUT} = 1$ to $40mA$	7.60		8.40	
		$I_{OUT} = 1$ to $70mA$	7.76		8.40	
Output current	$I_{OUT}$	-	100	-	-	mA
Quiescent current	$I_Q$	$I_{OUT} = 0mA$	-	4.0	6.0	mA
Quiescent current change	$\Delta I_Q$	$V_{IN} = 11$ to $23V$	-	-	1.5	mA
		$I_{OUT} = 1$ to $40mA$	-	-	0.1	mA
Dropout voltage	$V_{DO}^{(8)}$	-	-	1.7	-	V
Line regulation	$\Delta V_{LINE}$	$V_{IN} = 10.5$ to $23V$	-	42	175	mV
		$V_{IN} = 11$ to $23V$	-	36	125	
Load regulation	$\Delta V_{LOAD}$	$I_{OUT} = 1$ to $100mA$	-	18	80	mV
		$I_{OUT} = 1$ to $40mA$	-	10	40	
Output noise voltage	$V_N$	$f = 10$ to $100kHz$	-	54	-	$\mu V/V_{OUT}$
Ripple rejection	RR	$V_{IN} = 13$ to $23V$ , $f = 120Hz$	37	46	-	dB



### Typical Characteristics

Output Characteristics

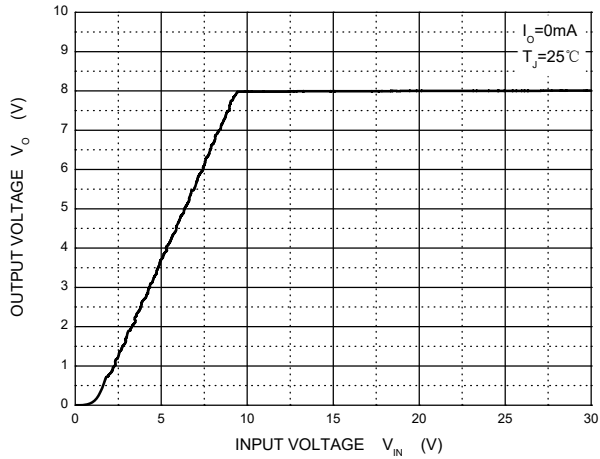

Dropout Characteristics

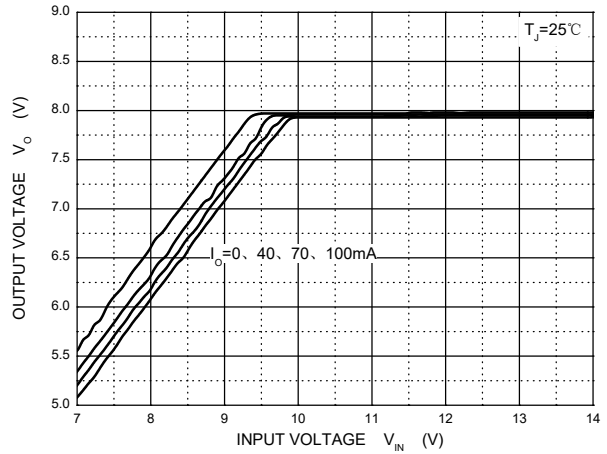

Quiescent Current vs Input Voltage

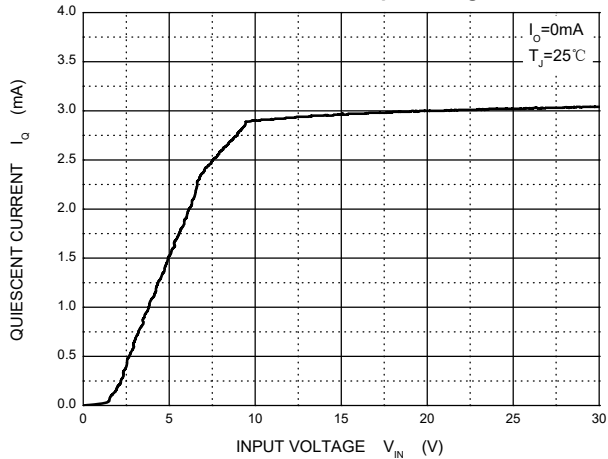

Current Cut-off Grid Voltage

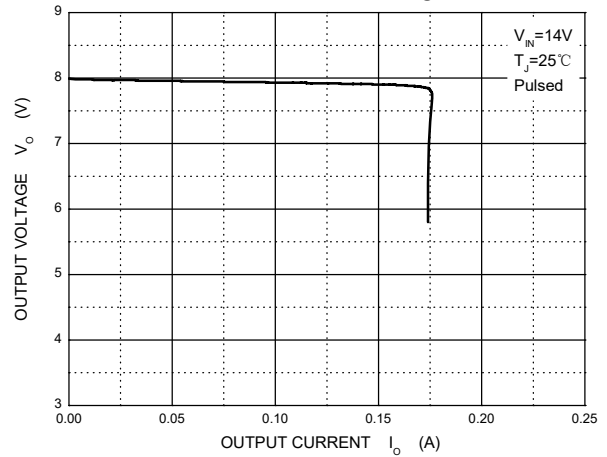

Output Voltage vs Junction Temperature

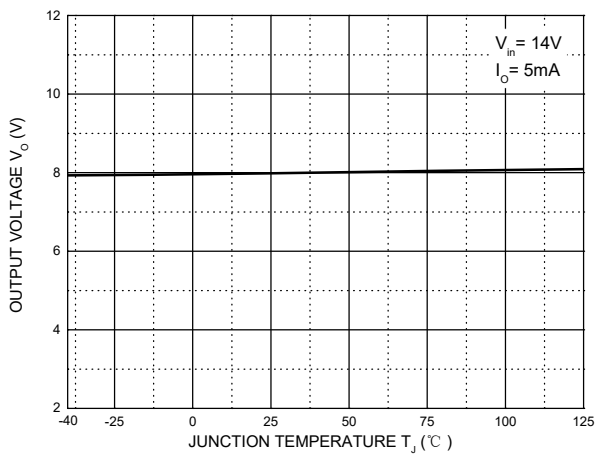

Power Derating Curve

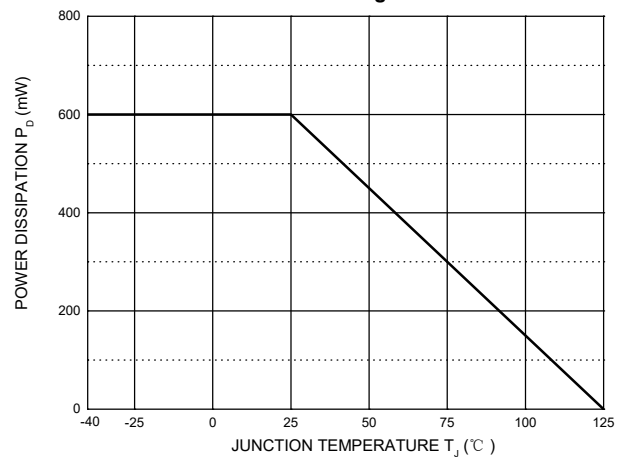



**SOT89-3L Package Outline Dimensions**

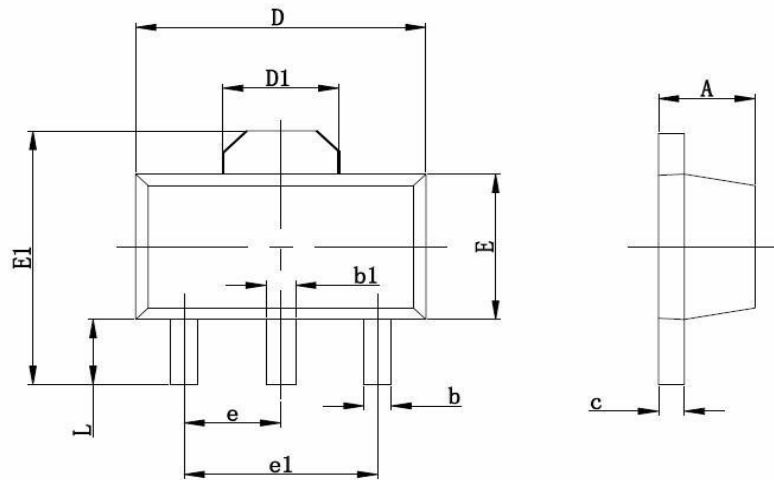

Symbol	Dimensions In Millimeters		Dimensions In Inches	
	Min	Max	Min	Max
A	1.400	1.600	0.055	0.063
b	0.320	0.520	0.013	0.020
b1	0.400	0.580	0.016	0.023
c	0.350	0.440	0.014	0.017
D	4.400	4.600	0.173	0.181
D1	1.550 REF.		0.061 REF.	
E	2.300	2.600	0.091	0.102
E1	3.940	4.250	0.155	0.167
e	1.500 TYP.		0.060 TYP.	
e1	3.000 TYP.		0.118 TYP.	
L	0.900	1.200	0.035	0.047



### Attention

- Any and all HUA XUAN YANG ELECTRONICS products described or contained herein do not have specifications that can handle applications that require extremely high levels of reliability, such as life-support systems, aircraft's control systems, or other applications whose failure can be reasonably expected to result in serious physical and/or material damage. Consult with your HUA XUAN YANG ELECTRONICS representative nearest you before using any HUA XUAN YANG ELECTRONICS products described or contained herein in such applications.
- HUA XUAN YANG ELECTRONICS assumes no responsibility for equipment failures that result from using products at values that exceed, even momentarily, rated values (such as maximum ratings, operating condition ranges, or other parameters) listed in products specifications of any and all HUA XUAN YANG ELECTRONICS products described or contained herein.
- Specifications of any and all HUA XUAN YANG ELECTRONICS products described or contained herein stipulate the performance, characteristics, and functions of the described products in the independent state, and are not guarantees of the performance, characteristics, and functions of the described products as mounted in the customer's products or equipment. To verify symptoms and states that cannot be evaluated in an independent device, the customer should always evaluate and test devices mounted in the customer's products or equipment.
- HUA XUAN YANG ELECTRONICS CO.,LTD. strives to supply high-quality high-reliability products. However, any and all semiconductor products fail with some probability. It is possible that these probabilistic failures could give rise to accidents or events that could endanger human lives, that could give rise to smoke or fire, or that could cause damage to other property. When designing equipment, adopt safety measures so that these kinds of accidents or events cannot occur. Such measures include but are not limited to protective circuits and error prevention circuits for safe design, redundant design, and structural design.
- In the event that any or all HUA XUAN YANG ELECTRONICS products(including technical data, services) described or contained herein are controlled under any of applicable local export control laws and regulations, such products must not be exported without obtaining the export license from the authorities concerned in accordance with the above law.
- No part of this publication may be reproduced or transmitted in any form or by any means, electronic or mechanical, including photocopying and recording, or any information storage or retrieval system, or otherwise, without the prior written permission of HUA XUAN YANG ELECTRONICS CO.,LTD.
- Information (including circuit diagrams and circuit parameters) herein is for example only ; it is not guaranteed for volume production. HUA XUAN YANG ELECTRONICS believes information herein is accurate and reliable, but no guarantees are made or implied regarding its use or any infringements of intellectual property rights or other rights of third parties.
- Any and all information described or contained herein are subject to change without notice due to product/technology improvement, etc. When designing equipment, refer to the "Delivery Specification" for the HUA XUAN YANG ELECTRONICS product that you intend to use.