

PCB Layout

Specifications:

规格:  
 Voltage rating:250V AC/DC  
 额定电压: 250V AC/DC  
 Current rating:3A AC/DC  
 额定电流: 3A AC/DC  
 Withstanding voltage:1000V AC/minute  
 耐受电压: 1000V AC/分钟  
 Temperature range:-25°C~+85°C  
 温度范围: -25°C~+85°C  
 Insulation resistance:1000MΩ min  
 绝缘电阻: 1000MΩ Min  
 Contact resistance:20mΩ Max  
 接触电阻: 20mΩ Max

X2501 W V - XX - N0 SN  
 ① ② ③ ④ ⑤ ⑥

- 1.Series No
- 2.Category:W-Wafer
- 3.Welding Board Angle:V-Straight 180°
- 4.Row No.Pin No:XX-02~16 Pin
- 5.Material:N0-PA66 UL94V-0 (Natrual)
- 6.Plating:SN-Tin Plated  
V01-Gold Flash

| Poles | Dimensions(mm) |       | Poles | Dimensions(mm) |       |
|-------|----------------|-------|-------|----------------|-------|
|       | A              | B     |       | A              | B     |
| 02    | 2.50           | 5.00  | 10    | 22.50          | 25.00 |
| 03    | 5.00           | 7.50  | 11    | 25.00          | 27.50 |
| 04    | 7.50           | 10.00 | 12    | 27.50          | 30.00 |
| 05    | 10.00          | 12.50 | 13    | 30.00          | 32.50 |
| 06    | 12.50          | 15.00 | 14    | 32.50          | 35.00 |
| 07    | 15.00          | 17.50 | 15    | 35.00          | 37.50 |
| 08    | 17.50          | 20.00 | 16    | 37.50          | 40.00 |
| 09    | 20.00          | 22.50 |       |                |       |

|                 |          |               |                      |
|-----------------|----------|---------------|----------------------|
| X2501WV-XX-N0SN | PA66     | Brass         | X2501H               |
| PART NO         | Material | Material(Pin) | Suitable XKB Housing |

|      |  |             |  |
|------|--|-------------|--|
| DSND |  | SCALE: N/A  | MODEL TYPE:<br>2.5mm Crimp Style Connector |
| DWN  |  | VIEW:       | PART NO.:<br>X2501WV-XX-N0SN               |
| CHKD |  | UNIT: mm/in | DWG NO.:<br>X-X2501WV-XX-N0SN              |
| APPD |  | SIZE: A4    |  |



XKB INDUSTRIAL PRECISION CO.,LIMITED

|        |       |          |
|--------|-------|----------|
| WEIGHT | SHEET | REVISION |
|        | 1/1   | A0       |

广东星坤科技股份有限公司

|     |    |
|-----|----|
| Δ 姓 | 日期 |
| Δ 数 |    |
| Δ X |    |

MARK DESCRIPTION

文件工程章

| REVISIONS | DATE | REVISED | APPROVED | UNSPECIFIED TOLERANCES |
|-----------|------|---------|----------|------------------------|
|           |      |         |          | ANGLAR ±5°             |
|           |      |         |          | L ≤ 4 ±0.2             |
|           |      |         |          | 4 < L ≤ 16 ±0.3        |
|           |      |         |          | 16 < L ≤ 63 ±0.4       |
|           |      |         |          | L > 63 ±0.5            |

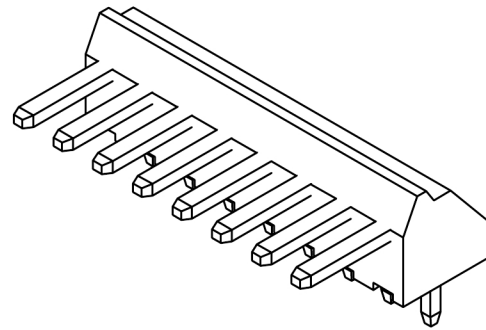
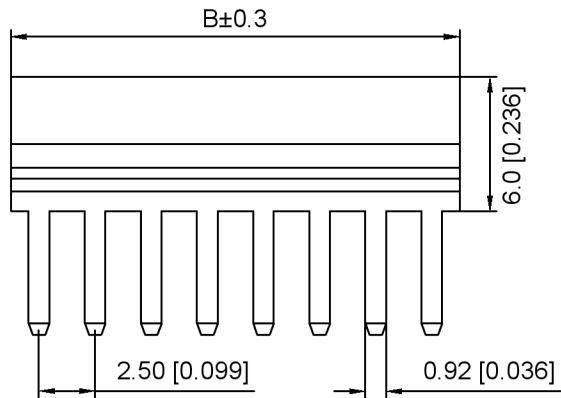

Specifications:  
 规格:  
 Voltage rating:250V AC/DC  
 额定电压: 250V AC/DC  
 Current rating:3A AC/DC  
 额定电流: 3A AC/DC  
 Withstanding voltage:1000V AC/minute  
 耐受电压: 1000V AC/分钟  
 Temperature range:-25°C~+85°C  
 温度范围: -25°C~+85°C  
 Insulation resistance:1000MΩ min  
 绝缘电阻: 1000MΩ Min  
 Contact resistance:20mΩ Max  
 接触电阻: 20mΩ Max

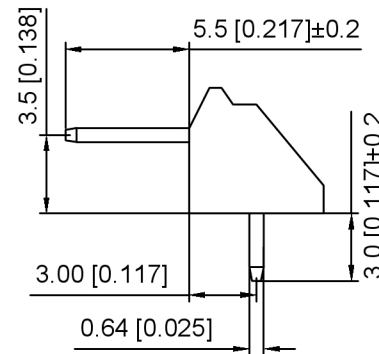
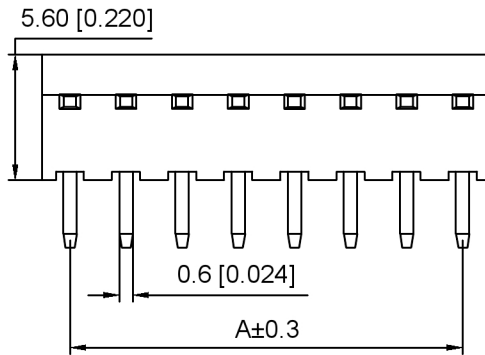

X2501 W R - XX - N0 SN  
 ① ② ③ ④ ⑤ ⑥

- 1.Series No
- 2.Category:W-Wafer
- 3.Welding Board Angle:R-Straight 90°
- 4.Row No.Pin No:XX-02~16 Pin
- 5.Material:N0-PA66 UL94V-0 (Natural)
- 6.Plating:SN-Tin Plated  
V01-Gold Flash

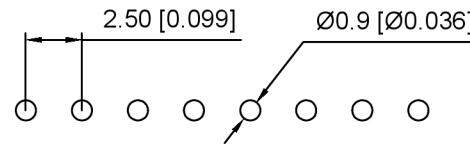
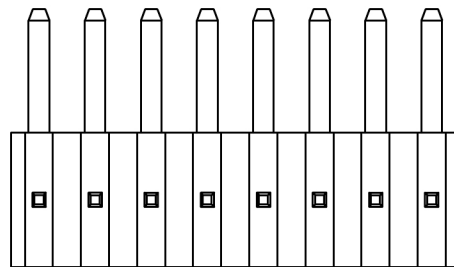

PCB Layout

| Poles | Dimensions(mm) |       | Poles | Dimensions(mm) |       |
|-------|----------------|-------|-------|----------------|-------|
|       | A              | B     |       | A              | B     |
| 02    | 2.50           | 5.00  | 10    | 22.50          | 25.00 |
| 03    | 5.00           | 7.50  | 11    | 25.00          | 27.50 |
| 04    | 7.50           | 10.00 | 12    | 27.50          | 30.00 |
| 05    | 10.00          | 12.50 | 13    | 30.00          | 32.50 |
| 06    | 12.50          | 15.00 | 14    | 32.50          | 35.00 |
| 07    | 15.00          | 17.50 | 15    | 35.00          | 37.50 |
| 08    | 17.50          | 20.00 | 16    | 37.50          | 40.00 |
| 09    | 20.00          | 22.50 |       |                |       |

|                 |          |               |                      |
|-----------------|----------|---------------|----------------------|
| X2501WR-XX-N0SN | PA66     | Brass         | X2501H               |
| PART NO         | Material | Material(Pin) | Suitable XKB Housing |

|      |  |             |  |
|------|--|-------------|--|
| DSND |  | SCALE: N/A  | MODEL TYPE:<br>2.5mm Crimp Style Connector |
| DWN  |  | VIEW:       | PART NO.:<br>X2501WR-XX-N0SN               |
| CHKD |  | UNIT: mm/in | DWG NO.:<br>X-X2501WR-XX-N0SN              |
| APPD |  | SIZE: A4    | WEIGHT SHEET REVISION                      |
|      |  |             | 1/1 A0                                     |



XKB INDUSTRIAL PRECISION CO., LIMITED

|                        |      |
|------------------------|------|
| ANGULAR                | ±5°  |
| L ≤ 4                  | ±0.2 |
| 4 < L ≤ 16             | ±0.3 |
| 16 < L ≤ 63            | ±0.4 |
| L > 63                 | ±0.5 |
| UNSPECIFIED TOLERANCES |      |

广东星坤科技股份有限公司

文件工程章

日期

| MARK | DESCRIPTION | DATE | REVISED | APPROVED |
|------|-------------|------|---------|----------|
| Δ*   |             |      |         |          |
| Δx   |             |      |         |          |
| Δ*   |             |      |         |          |

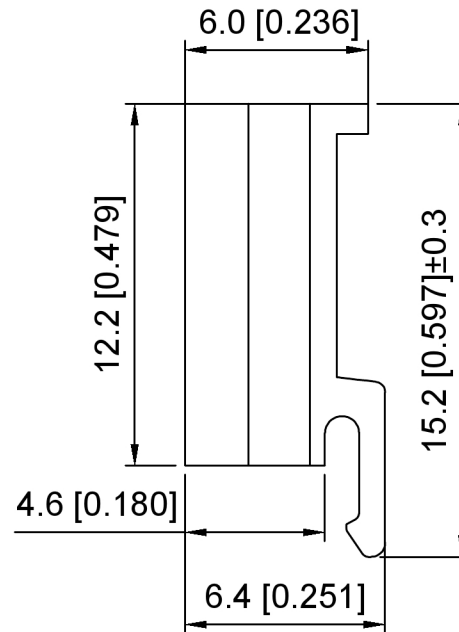
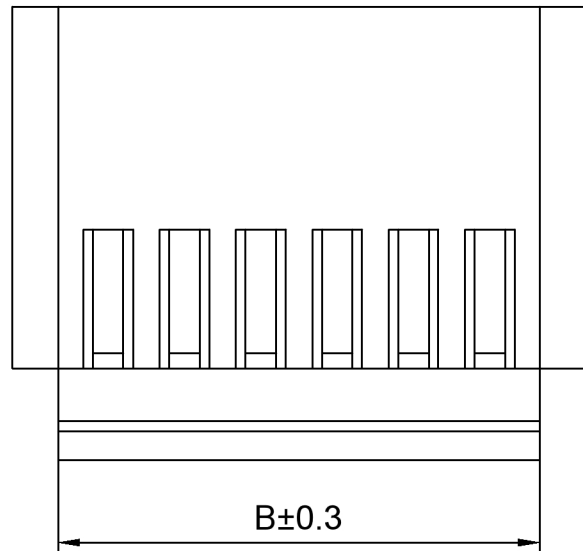
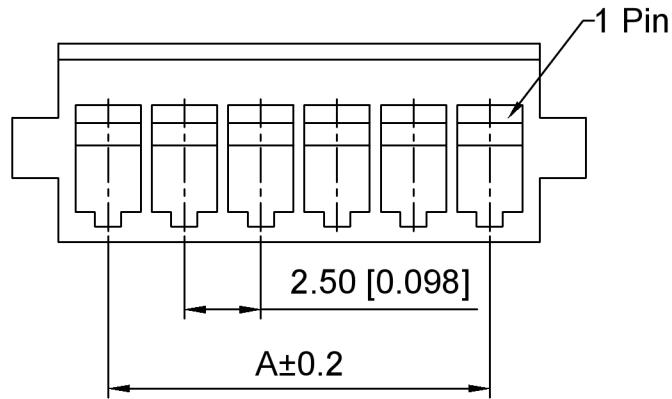

Specifications:

规格:

Voltage rating:250V AC/DC

额定电压: 250V AC/DC

Current rating:3A AC/DC

额定电流: 3A AC/DC

Withstanding voltage:1500V AC/minute

耐受电压: 1500V AC/分钟

Temperature range:-25°C~+85°C

温度范围: -25°C~+85°C

Insulation resistance:500MΩ min

绝缘电阻: 500MΩ Min

Contact resistance:15mΩ Max

接触电阻: 15mΩ Max

X2501 H - XX - N0 X  
 ① ② ③ ④ ⑤

1.Series No

2.Category:H-Housing

3.Row No.Pin No:XX-02~25 Pin

4.Material:N0-PA66 UL94V-0

5.Color: BK-Black ; BN-Brown ; BL-Blue  
 R-Red ; G-Green ; W-White ; Y-Yellow

| Poles | Dimensions(mm) |       | Poles | Dimensions(mm) |       |
|-------|----------------|-------|-------|----------------|-------|
|       | A              | B     |       | A              | B     |
| 02    | 2.50           | 5.90  | 14    | 32.50          | 35.90 |
| 03    | 5.00           | 8.40  | 15    | 35.00          | 38.40 |
| 04    | 7.50           | 10.90 | 16    | 37.50          | 40.90 |
| 05    | 10.00          | 13.40 | 17    | 40.00          | 43.40 |
| 06    | 12.50          | 15.90 | 18    | 42.50          | 45.90 |
| 07    | 15.00          | 18.40 | 19    | 45.00          | 48.40 |
| 08    | 17.50          | 20.90 | 20    | 47.50          | 50.90 |
| 09    | 20.00          | 23.40 | 21    | 50.00          | 53.40 |
| 10    | 22.50          | 25.90 | 22    | 52.50          | 55.90 |
| 11    | 25.00          | 28.40 | 23    | 55.00          | 58.40 |
| 12    | 27.50          | 30.90 | 24    | 57.50          | 60.90 |
| 13    | 30.00          | 33.40 | 25    | 60.00          | 63.40 |

|               |          |                    |                       |
|---------------|----------|--------------------|-----------------------|
| X2501H-XX-N0X | PA66     | X2501W             | X2501T                |
| PART NO       | Material | Suitable XKB Wafer | Suitable XKB Terminal |

|      |             |  |
|------|-------------|--|
| DSND | SCALE: N/A  | MODEL TYPE:<br>2.5mm Crimp Style Connector |
| DWN  | VIEW:       | PART NO.:<br>X2501H-XX-N0X                 |
| CHKD | UNIT: mm/in | DWG NO.:<br>X-X2501H-XX-N0X                |
| APPD | SIZE: A4    |  |



XKB INDUSTRIAL PRECISION CO.,LIMITED

|        |       |          |
|--------|-------|----------|
| WEIGHT | SHEET | REVISION |
|        | 1/1   | A0       |

广东星坤科技股份有限公司

|    |    |
|----|----|
| Δ姓 | 日期 |
| Δ数 |    |
| ΔX |    |

|       |             |      |         |          |
|-------|-------------|------|---------|----------|
| MARK  | DESCRIPTION | DATE | REVISED | APPROVED |
| 文件工程草 |             |      |         |          |

|                        |      |
|------------------------|------|
| ANGULAR                | ±5°  |
| L ≤ 4                  | ±0.2 |
| 4 < L ≤ 16             | ±0.3 |
| 16 < L ≤ 63            | ±0.4 |
| L > 63                 | ±0.5 |
| UNSPECIFIED TOLERANCES |      |

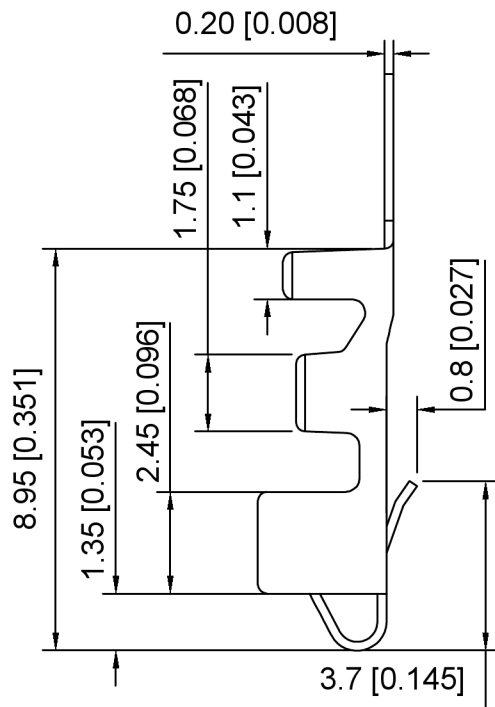
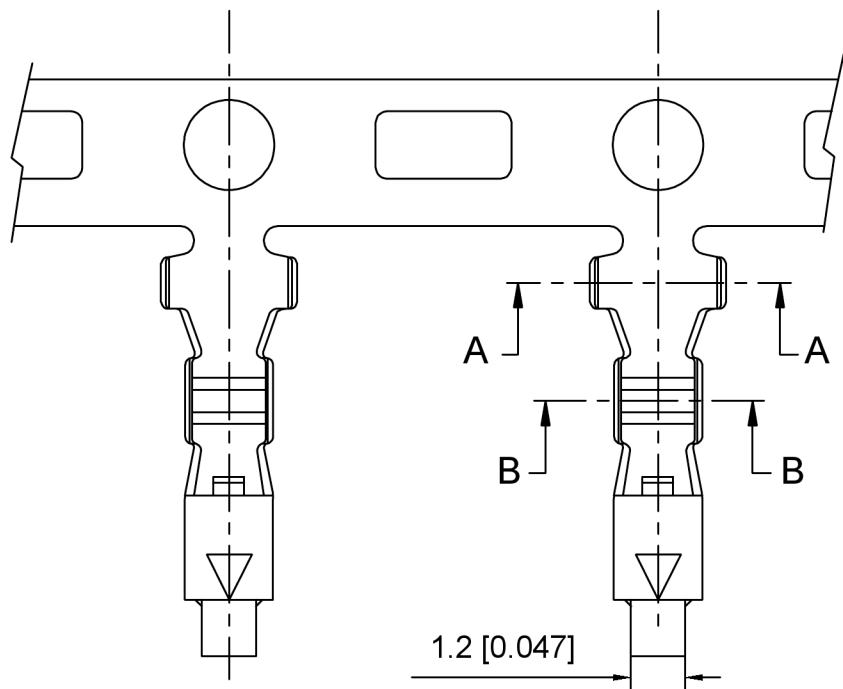

Specifications:  
 规格:  
 Voltage rating:250V AC/DC  
 额定电压: 250V AC/DC  
 Current rating:3A AC/DC  
 额定电流: 3A AC/DC  
 Withstanding voltage:1500V AC/minute  
 耐受电压: 1500V AC/分钟  
 Temperature range:-25°C~+85°C  
 温度范围: -25°C~+85°C  
 Insulation resistance:500MΩ min  
 绝缘电阻: 500MΩ Min  
 Contact resistance:10mΩ Max  
 接触电阻: 10mΩ Max

X2501 T - P SN  
 ① ② ③ ④

- 1. Series No
- 2. Category:T-Terminal
- 3. Material:P-Phosphor Bronze
- 4. Plating:SN-Tin Plating  
V01-Gold Flash

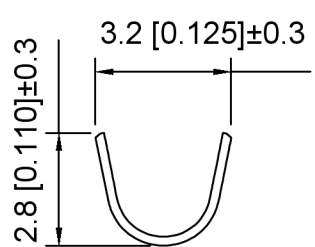

SEC:A-A

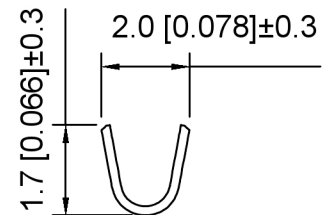
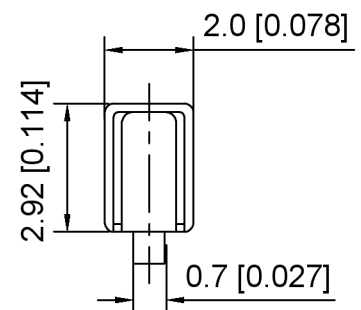

SEC:B-B

|            |                 |                        |                      |
|------------|-----------------|------------------------|----------------------|
| X2501T-PSN | Phosphor Bronze | AWG#22~28<br>O.D.1.8mm | X2501H               |
| PART NO    | Material        | Wire Range             | Suitable XKB Housing |

|      |             |  |
|------|-------------|--|
| DSND | SCALE: N/A  | MODEL TYPE:<br>2.5mm Crimp Style Connector |
| DWN  | VIEW:       | PART NO.:<br>X2501T-PSN                    |
| CHKD | UNIT: mm/in | DWG NO.:<br>X-X2501T-PSN                   |
| APPD | SIZE: A4    |  |

广东星坤科技股份有限公司

|    |    |
|----|----|
| Δ# | 日期 |
| Δx |    |
| Δx |    |
| Δx |    |

| MARK | DESCRIPTION | DATE | REVISED | APPROVED | UNSPECIFIED TOLERANCES |
|------|-------------|------|---------|----------|------------------------|
|      | REVISIONS   |      |         |          |                        |



XKB INDUSTRIAL PRECISION CO., LIMITED

|        |       |          |
|--------|-------|----------|
| WEIGHT | SHEET | REVISION |
|        | 1/1   | A0       |

文件工程章