

版次	变更摘要	日期
0		

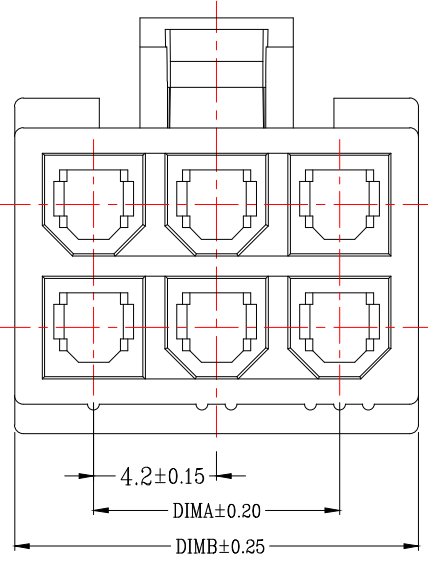
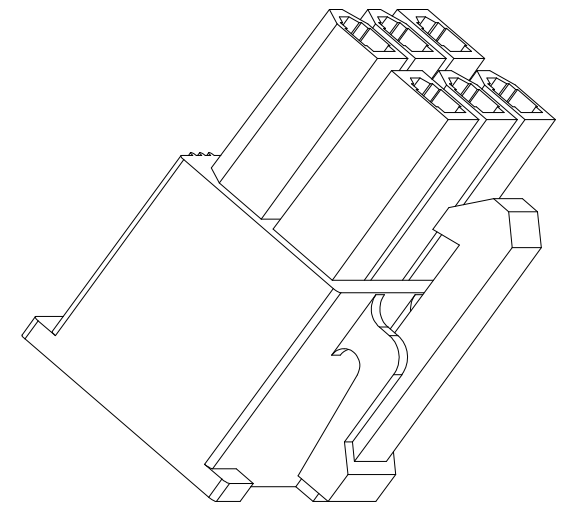
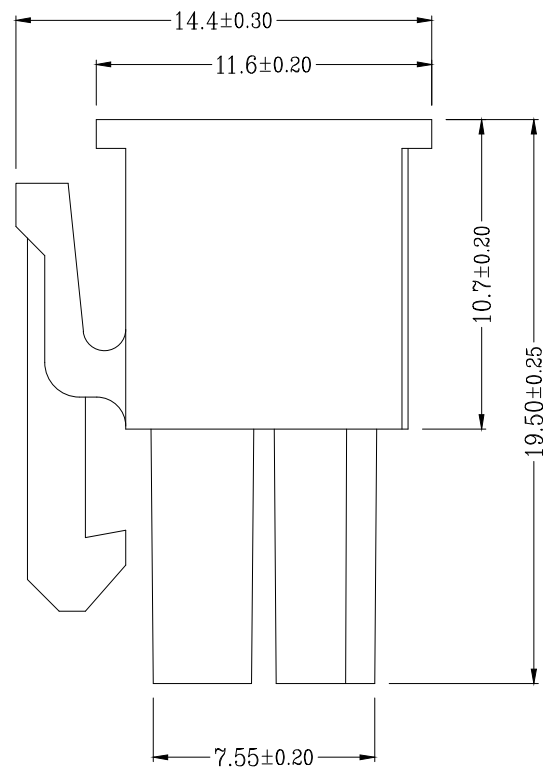

技术指标:

1. 温度范围:  $-25^{\circ}\text{C} \sim 85^{\circ}\text{C}$ .
2. 额定电压: 250V AC, DC.
3. 耐电压: 1500V AC/minute.
4. 接触电阻:  $\leq 20\text{m}\Omega$ .
5. 绝缘电阻:  $\geq 1000\text{M}\Omega$ .
6. 额定电流: 5A AC, DC.

CKT	A	B
2*1		5.50
2*2	4.20	9.70
2*3	8.40	13.90
2*4	12.60	18.10
2*5	16.80	22.30
2*6	21.00	26.50
2*7	25.20	30.70
2*8	29.40	34.90
2*9	33.60	39.10
2*10	37.80	43.30
2*11	42.00	47.50
2*12	46.20	51.70



兆星精密电子 (深圳) 有限公司

品名 (TITLE)	5557双排4.2公头胶壳2代		制图 (DR)
料号 (DWG.NO)	ZX-5557-4.2-2-1P-HGJK		校对 (CHKD)
比例 (SCALE)	1:1	单位 (UNITS)	mm
张数 (SHEET)	1 OF 1	尺寸 (SIZE)	A4
审核 (APPD)		REV	A

一般公差 (TOLERANCE)  
X: ±.50 .XX ±.10  
.X ±.20 .XXX ±.05  
ANGLES ±1°