

版次 0	变更摘要	日期	序号	品名	材质
			①	MX3.0双排弯针WTB胶芯	PA66 UL94V-0 黑色
			②	MX3.0双排弯针WTB端子	铜合金/表面镀锡

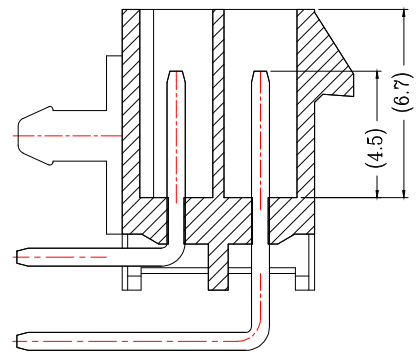
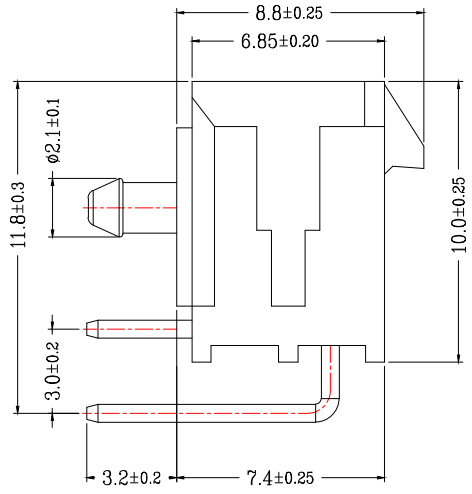
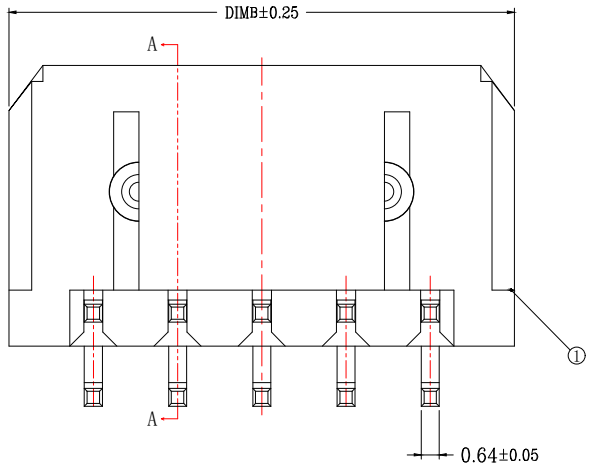
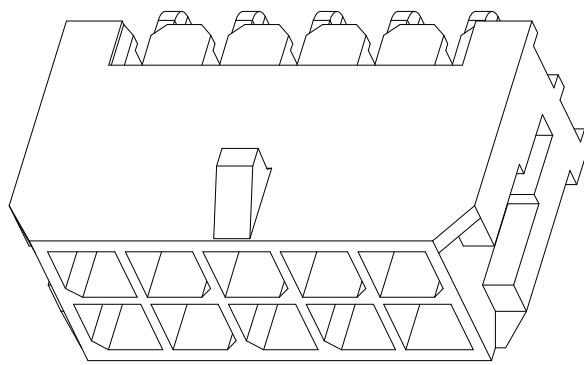
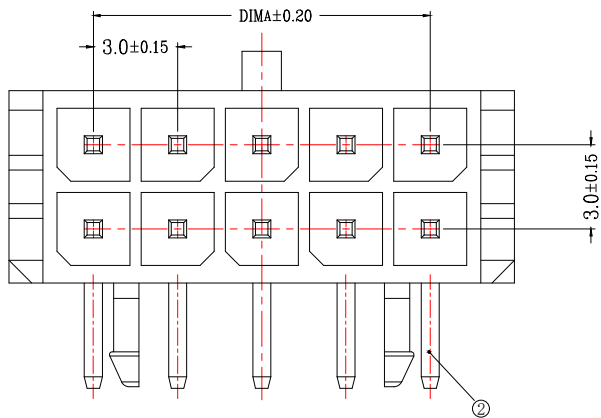

SECTION A-A

CKT	A	B
2*1		6.00
2*2	3.0	9.00
2*3	6.0	12.00
2*4	9.0	15.00
2*5	12.0	18.00
2*6	15.0	21.00
2*7	18.0	24.00
2*8	21.0	27.00
2*9	24.0	30.00
2*10	27.0	33.00
2*11	30.0	36.00
2*12	33.0	39.00

技术指标 (Technical Index):

1. 温度范围 (Temperature range): $-25^{\circ}\text{C} \sim +85^{\circ}\text{C}$.
2. 额定电压 (Rated voltage): 600V, AC, DC.
3. 额定电流 (Rated current): 5.0A AC, DC.
4. 接触电阻 (Contact resistance): $\leq 20\text{m}\Omega$.
5. 耐压值 (Withstanding voltage): 1500V AC/minute.
6. 绝缘电阻 (Insulation resistance): $\geq 1000\text{M}\Omega$.

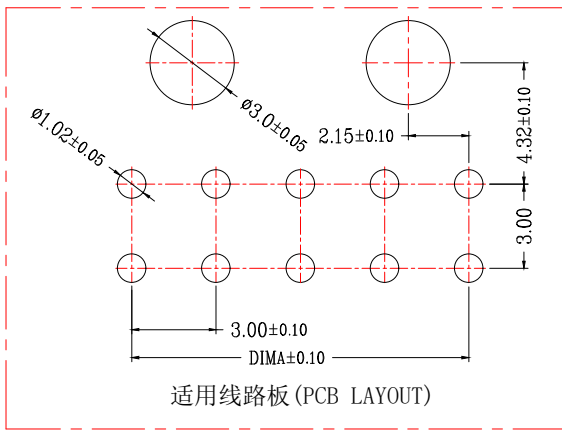

兆星精密电子 (深圳) 有限公司

品名 (TITLE)	MX3.0双排弯针WTB	制图 (DR)	
料号 (DWG.NO)	ZX-MX3.0-2-2PWZ	校对 (CHKD)	
比例 (SCALE)	1:1	审核 (APPD)	
单位 (UNITS)	mm	张数 (SHEET)	1 OF 1
		SIZE	A4
		REV	A

一般公差 (TOLERANCE)
 X: ±.50 XX: ±1.0
 .X: ±.20 .XXX: ±.05
 ANGLES: ±1°