

规格书

Specification

品名
Model name

HYT-1203 IC

PROPRIETARY
Huayu Electronic co.,Ltd.

CONFIDENTIAL
Huayu Electronic co.,Ltd.

Version #	Spec V1.0
制作日期 Date	2018/4/01
准备 Prepared	Yi Shen Acoustic specialist,R&D Dept.
承认 Approved	Qian Wanjin Executive Manager,R&D Dept.



兴化市华宇电子有限公司

地址：江苏省兴化市陈堡工业区人民路 1 号

电话：13625199874 传真：0523-83723118

邮箱：3912453758@qq.com 网址：www.js-huayu.com

*Components Operating Div.
Huayu Electronic co.,Ltd.*

1.适用范围：本规范适用于 HYT-1203 IC 蜂鸣器。

This specifications apply the HYT-1203 IC buzzer.

2.基本规格/General specification

项目/Item	规格/Spec	条件/Condition
1 额定电压 Rated voltage	3VDC	
2 工作电压 Operation voltage	2~5VDC	
3 声压 Sound Pressure Level=SPL	Min 85dB	测试环境：标准状态，标准驱动电路，额定电压 测试距离：0.1m Standard State,Standard Drive Circuit. Rated voltage,Distance at 0.1m
4 平均消费电流 Average consumption current	Max 30mA	
5 振荡频率 Oscillation frequency	2700±100Hz	
6 响应时间 Response time	Max 50mS	
7 工作温度范围 Range of operation temperature	-30~+80°C	
8 保存温度范围 Range of preservation temperature	-40~+85°C	
9 端子强度 Terminal strength	10N	拉负荷方向的终端轴 Pull load on the direction of the terminal axis
10 外部尺寸 Externals size	Φ12x9.5	参阅附图 Refer to the attached drawing
11 重量 Mass	2g	

3. 电气和声学测试条件/Electrical And Acoustical Measuring Condition

驱动电路/Recommended Driving Circuit

Resonant frequency, 1/2 duty cycle. Square wave.
Signal amplitude should be large enough to saturate the transistor.

设置 Recommended Setting

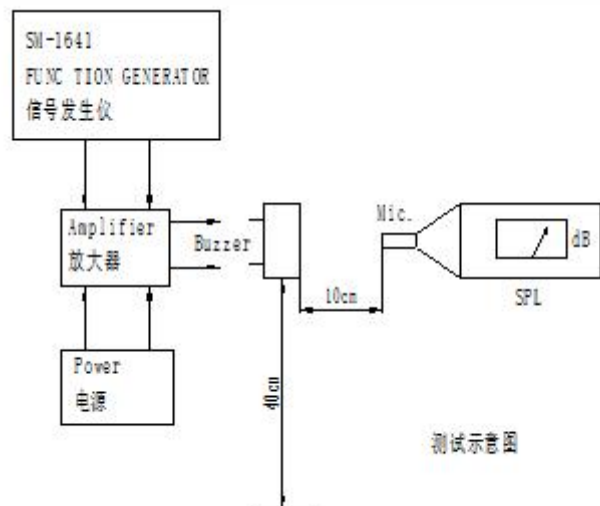
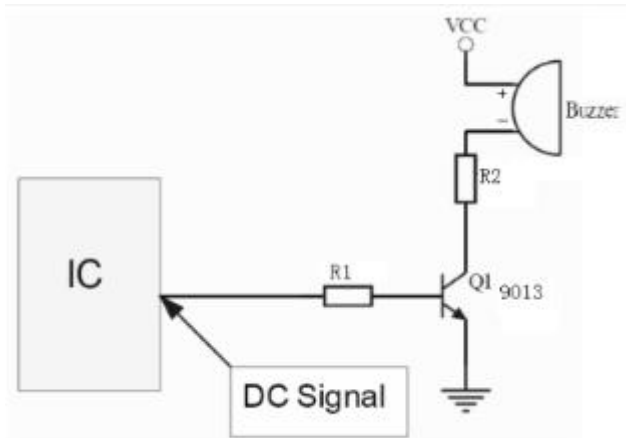

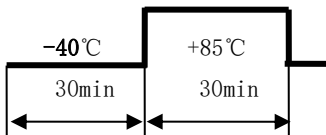
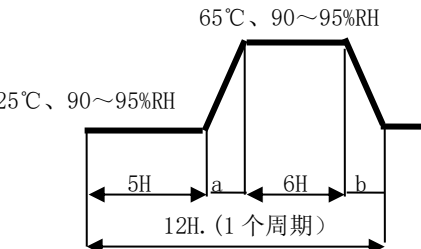
项目/Item		试验条件/Test condition	判断标准/Criteria	引用规格
1	高温保存试验 High temperature Preservation	+85℃环境下放置 96 小时 Exposure to +85℃ for 96 hrs.	经过测试,符合规格,没有任何不合格的外观和性能,除了是 80 分贝或以上 (2700±100 Hz) After the test the part shall meet specifications without any degradation in appearance and performance except SPL. SPL shall be 80 dB More. (at 2700±100 Hz)	GB/T 2423.2
2	低温保存试验 Low temperature preservation	-40℃环境下放置 96 小时 Exposure to -40℃ for 96 hrs.		GB/T 2423.1
3	耐温试验 Thermal Shock	 10 次周期 10 cycles		GB/T 2423.4
4	温湿度试验 Thermal, Humidity Shock	 10 cycles		
5	常温寿命试验 Ordinary Temp. Life	常温 (25℃±10℃) 电压 3VDC 连续测试 1000 小时 Driving the sounder at 3VDC for 1000hrs in the room temperature (25℃±10℃)		
6	高温寿命试验 High Temp. Life	高温 (+85℃) 电压 3VDC 连续测试 500 小时 Driving the sounder at 3VDC for 500hrs in the low temperature (+85℃)		
7	低温寿命试验 Low Temp. Life	低温 (-40℃) 电压 3VDC 连续测试 500 小时 Driving the sounder at 3VDC for 500hrs in the low temperature (-40℃)		
8	引脚拉力试验 Lead strength	10N 的拉力在引脚上拉 10±1 秒 Pull load on the direction of the terminal axis for 10±1 sec.		GB/T 2423.29
9	振动试验 Vibration	10~55~10Hz 正弦波测试 1 分钟, 振幅 1.52mm 最大 91m/S ² X, Y, Z 三个方向每个 2 小时总计 6 小时 10~55~10Hz Sinewave, Sweep 1 min, Amplitude 1.52mm Max 91m/S ² X, Y, Z 3Direction 2hrs each, Total 6hrs		GB/T 2423.10
10	自由掉落试验 Free drop	70cm 高自由掉落到厚 40mm 的木板上, 每个方向一次 Free drop, 70cm height, on wood board (t40mm) X, Y, Z 3Direction 1time each, total 3times.	排除弯曲的针 Exclude bending of Pin	GB/T 2423.8
11	波峰焊耐热试验 Solder heat resistance	250±5℃焊接温度。浸泡时间 3±0.2sec Soldering into solderbath: Solder Temp. 250±5℃ Soaking Time: 3±0.2sec	经过测试,符合规格,没有任何不合格的外观和性能 After the test the part shall meet specifications without any degradation in appearance and performance	GB/T 2423.28
12	耐洗性试验 Washability	溶剂: 去离子水, 溶剂温度: 55±5℃, 浸泡时间: 5±0.5 分钟 Solvent: deionized water, Solvent temp: 55±5℃ Soaking time: 5±0.5 minutes		
13	引脚可焊性试验 Solderability	40℃, 相对湿度 90~95%RH 放置 240 小时, 370±5℃焊接温度。 浸泡时间: 6±0.5sec。 Pretreatment: 40℃, 90~95%RH*240hrs Soldering into solderbath: Solder Temp. 370±5℃ Soaking Time: 6±0.5sec	引脚 95% 必须覆盖着焊料 95% surface of lead pins must be covered with fresh solder and no soldering holes Should be found	GB/T 2423.28

5. 尺寸图/Dimension

(UNT: mm)

Tolerance: $\pm 0.5\text{mm}$ Except Specified

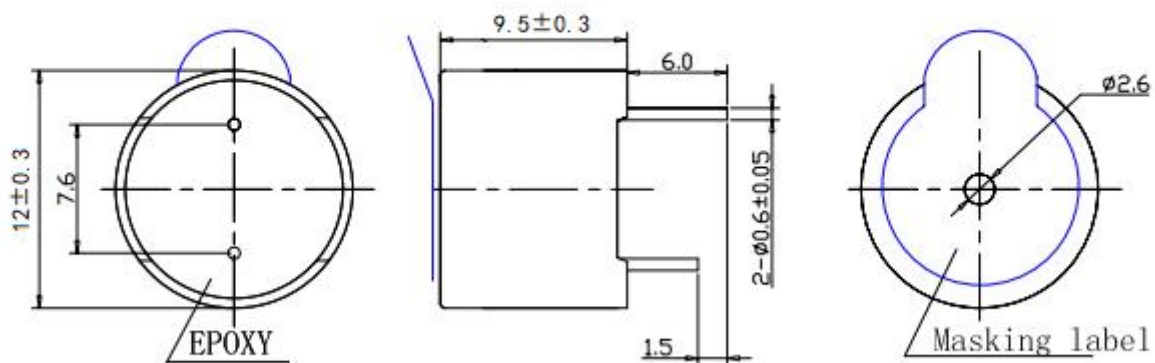

6. 频率图/Frequency Curve

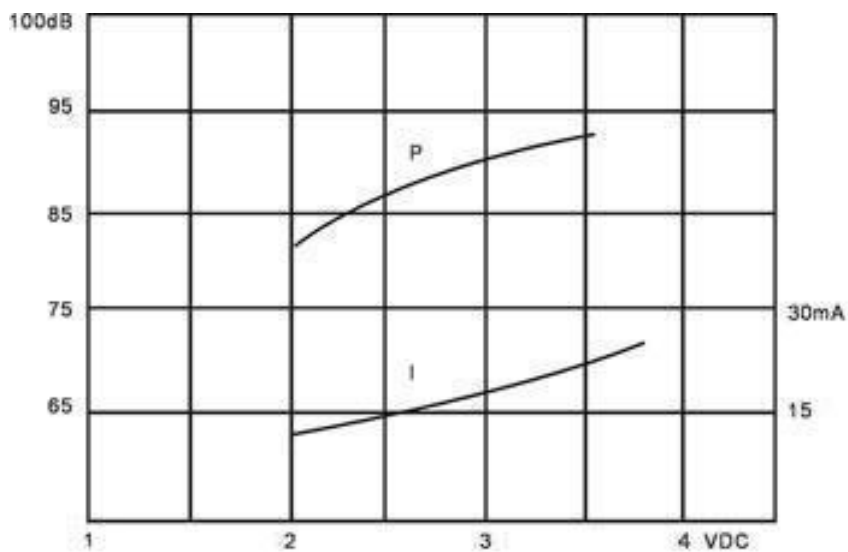

3Vo-p 50% duty Square wave, 10cm

7. Packing Method/包装图

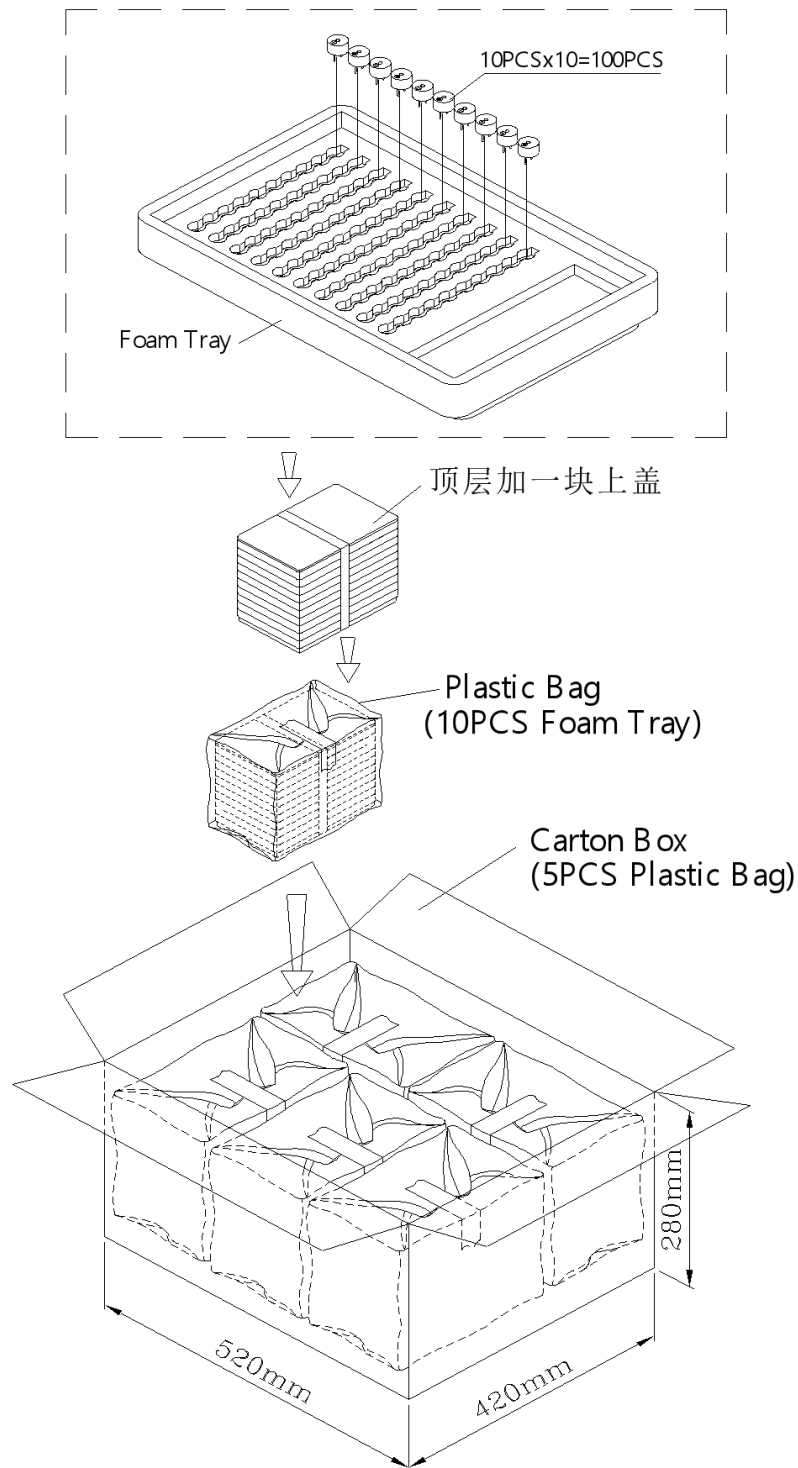

Foam Tray	240mmx160mmx30mm	1x100PCS=100PCS
Plastic Bag		10x100PCS=1000PCS
Carton Box	520mmx420mmx280mm	5x1000PCS=5,000PCS



兴化市华宇电子有限公司

Components Operating Div.
Huayu Electronic co.,Ltd.