

版次 0	变更摘要	日期	序号	品名	材质
			①	MX3.0双排直针WTB胶芯	PA66 UL94V-0 黑色
			②	MX3.0双排直针WTB端子	铜合金/表面镀锡

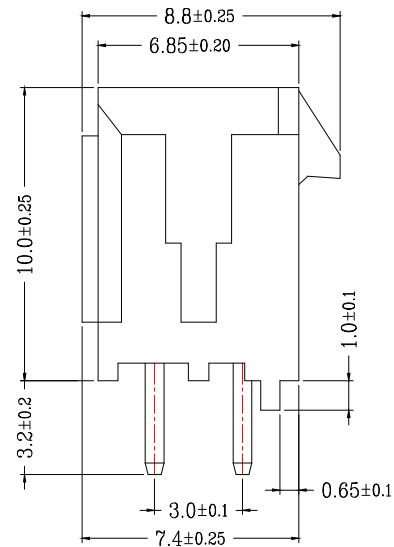

TYPE 1(无K脚)

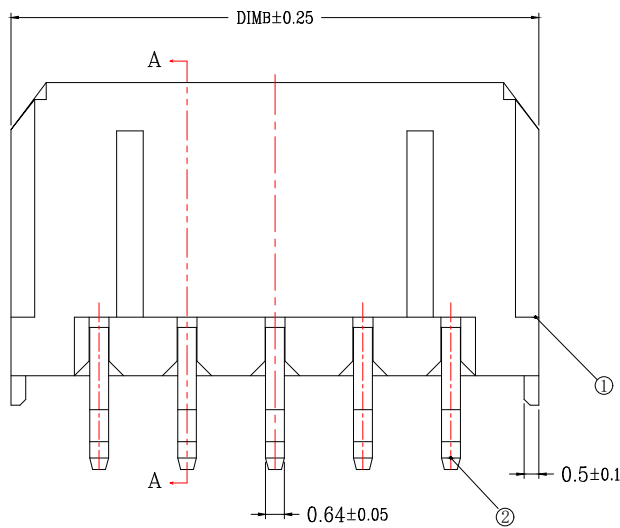
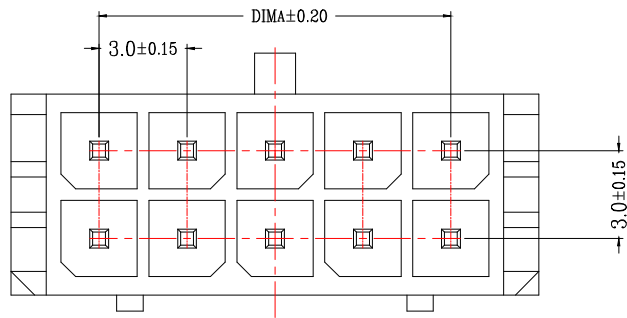
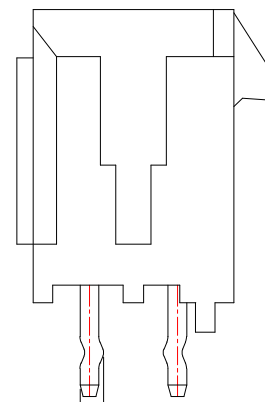

TYPE 2(打K脚)

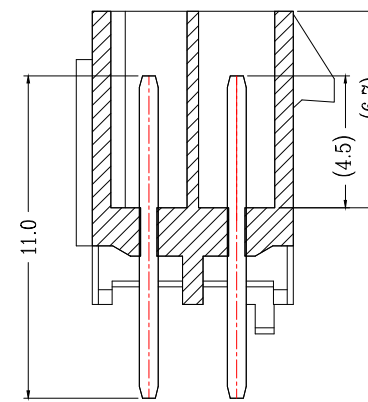
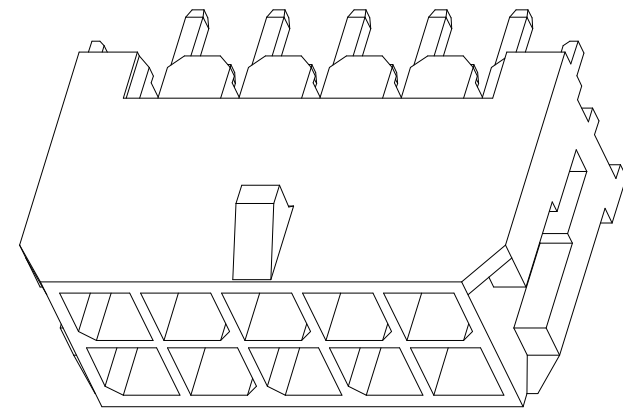

SECTION A-A

CKT	A	B
2*1		6.00
2*2	3.0	9.00
2*3	6.0	12.00
2*4	9.0	15.00
2*5	12.0	18.00
2*6	15.0	21.00
2*7	18.0	24.00
2*8	21.0	27.00
2*9	24.0	30.00
2*10	27.0	33.00
2*11	30.0	36.00
2*12	33.0	39.00

技术指标(Technical Index):

1. 温度范围(Temperature range): -25° C~+85° C.
2. 额定电压(Rated voltage): 600V, AC, DC.
3. 额定电流(Rated current): 5.0A AC, DC.
4. 接触电阻(Contact resistance): ≤20mΩ .
5. 耐压值(Withstanding voltage): 1500V AC/minute.
6. 绝缘电阻(Insulation resistance): ≥1000MΩ.

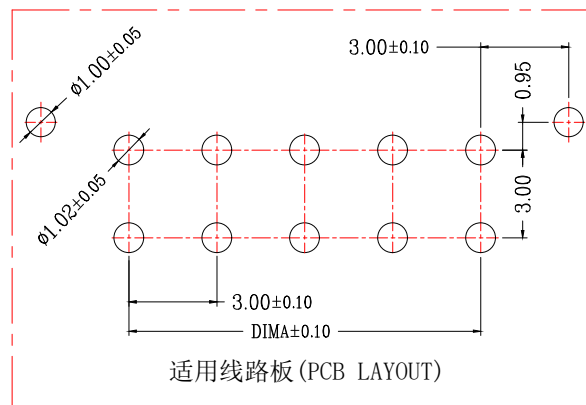

适用线路板(PCB LAYOUT)



一般公差(TOLERANCE)
 X: ±.50 XX ±.10
 .X ±.20 .XXX ±.05
 ANGLES ±1°

兆星精密电子(深圳)有限公司

品名(TITLE)	MX3.0双排直针WTB	制图(DR)	
料号(DWG.NO)	ZX-MX3.0-2-9PZZ	校对(CHKD)	
比例(SCALE)	1:1	审核(APPD)	
单位(UNITS)	mm	张数(SHEET)	1 OF 1
		SIZE	A4
		REV	A