

- ★ Green Device Available
- ★ Super Low Gate Charge
- ★ Excellent CdV/dt effect decline
- ★ Advanced high cell density Trench technology
- ★ 100% EAS Guaranteed

Product Summary

BVDSS	R _{DS(on)}	I _D
40V	17mΩ	20A

Description

The 4886D is the high cell density trenched N-ch MOSFETs, which provide excellent R_{DS(on)} and gate charge for most of the synchronous buck converter applications.

The 4886D meet the RoHS and Green Product, requirement 100% EAS guaranteed with full function reliability approved.

PDFN3* 3 Pin Configuration

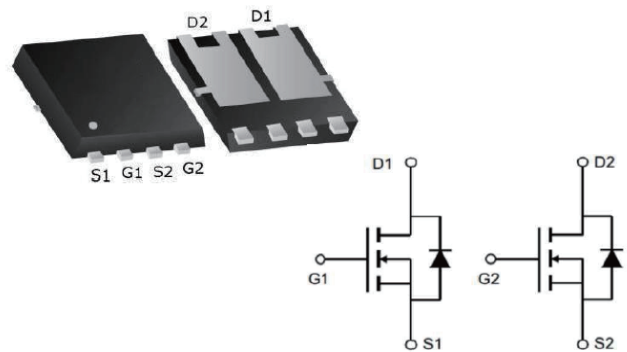

Absolute Maximum Ratings

Symbol	Parameter	Value	Unit
V _{DS}	Drain-Source Voltage	40	V
V _{GS}	Gate-Source Voltage	±20	V
I _{D@Tc=25°C}	Continuous Drain Current ₁	20	A
I _{D@Tc=70°C}	Continuous Drain Current ₁	13	A
I _{DM}	Pulsed Drain Current ₂	43	A
EAS	Single Pulse Avalanche Energy ₃	13	mJ
I _{AS}	Avalanche Current	20	A
P _{D@Tc=25°C}	Total Power Dissipation ₄	3.0	W
T _{STG}	Storage Temperature Range	-55 to 150	°C
T _J	Operating Junction Temperature Range	-55 to 150	°C

Thermal Data

Symbol	Parameter	Typ.	Max.	Units
R _{θJA}	Thermal Resistance Junction-ambient ₁ (t _s ≤10s)	---	62.5	°C/W
	Thermal Resistance Junction-ambient ₁	---	65	°C/W

Electrical Characteristics ($T_J = 25^\circ\text{C}$ unless otherwise specified)

Symbol	Parameter	Test condition	Min.	Typ.	Max.	Units
Off Characteristic						
$V_{(BR)DSS}$	Drain-Source Breakdown Voltage	$V_{GS}=0V, I_D=250\mu A$	40	-	-	V
I_{DSS}	Zero Gate Voltage Drain Current	$V_{DS}=40V, V_{GS}=0V$	-	-	1	μA
I_{GSS}	Gate to Body Leakage Current	$V_{DS}=0V, V_{GS}=\pm 20V$	-	-	± 100	nA
On Characteristics						
$V_{GS(th)}$	Gate Threshold Voltage	$V_{DS}=V_{GS}, I_D=250\mu A$	1	1.5	2.5	V
$R_{DS(on)}$	Static Drain-Source on-Resistance <small>note3</small>	$V_{GS}=10V, I_D=8A$	-	17	22	$m\Omega$
		$V_{GS}=4.5V, I_D=5A$	-	25	35	$m\Omega$
Dynamic Characteristics						
C_{iss}	Input Capacitance	$V_{DS}=20V, V_{GS}=0V,$ $f=1.0MHz$	-	633	-	pF
C_{oss}	Output Capacitance		-	67	-	pF
C_{riss}	Reverse Transfer Capacitance		-	58	-	pF
Q_g	Total Gate Charge	$V_{DS}=20V, I_D=8A,$ $V_{GS}=10V$	-	12	-	nC
Q_{gs}	Gate-Source Charge		-	3.2	-	nC
Q_{gd}	Gate-Drain("Miller") Charge		-	3.1	-	nC
Switching Characteristics						
$t_{d(on)}$	Turn-on Delay Time	$V_{DD}=20V, R_L=2.5\Omega$ $V_{GS}=10V, R_{REN}=3\Omega$	-	4	-	ns
t_r	Turn-on Rise Time		-	3	-	ns
$t_{d(off)}$	Turn-off Delay Time		-	15	-	ns
t_f	Turn-off Fall Time		-	2	-	ns
Drain-Source Diode Characteristics and Maximum Ratings						
I_S	Maximum Continuous Drain to Source Diode Forward Current		-	-	8	A
I_{SM}	Maximum Pulsed Drain to Source Diode Forward Current		-	-	32	A
V_{SD}	Drain to Source Diode Forward Voltage	$V_{GS}=0V, I_S=8A$	-	-	1.2	V

Note :

1. Repetitive Rating: Pulse Width Limited by Maximum Junction Temperature.
2. EAS condition : $T_J=25^\circ\text{C}, V_{DD}=20V, V_G=10V, L=0.5mH, R_g=25\Omega, I_{AS}=7.2A$
 $T_J=25^\circ\text{C}, V_{DD}=-20V, V_G=-10V, L=0.5mH, R_g=25\Omega, I_{AS}=-8.4A$
3. Pulse Test: Pulse Width $\leq 300\mu s$, Duty Cycle $\leq 2\%$

Typical Performance Characteristics

Figure 1: Output Characteristics

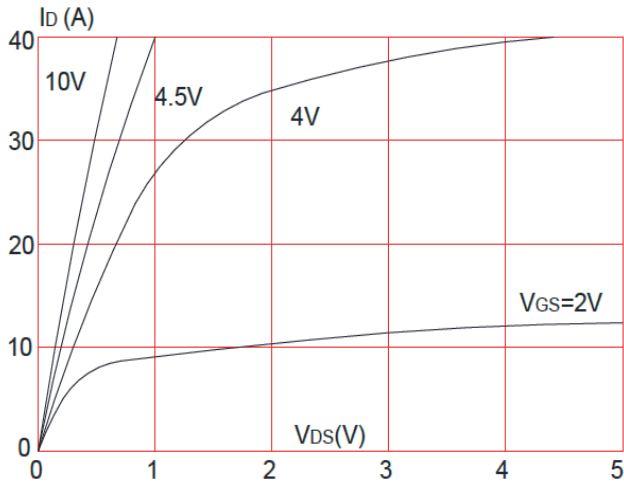

Figure 2: Typical Transfer Characteristics

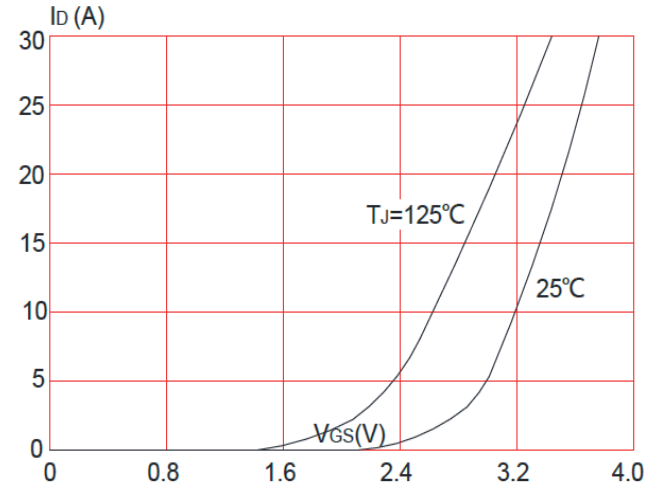

Figure 3: On-resistance vs. Drain Current

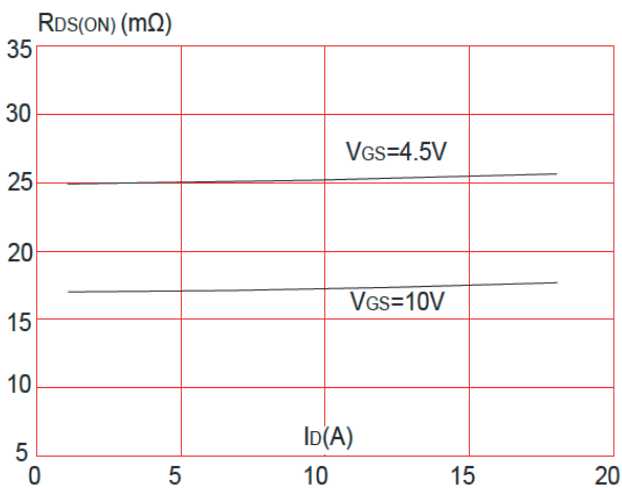

Figure 4: Body Diode Characteristics

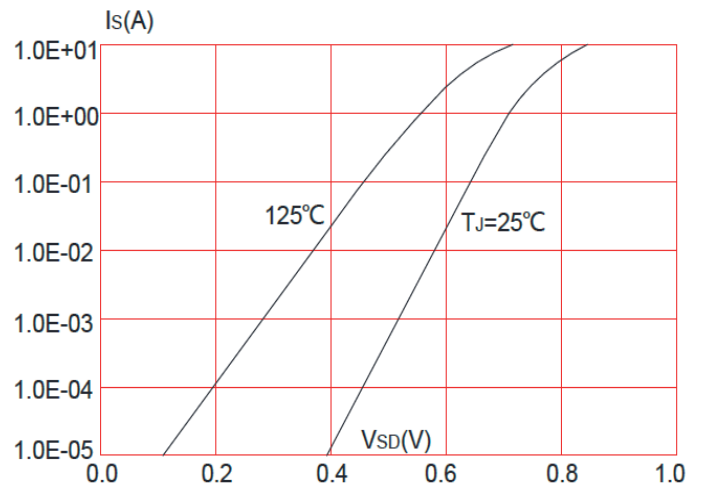

Figure 5: Gate Charge Characteristics

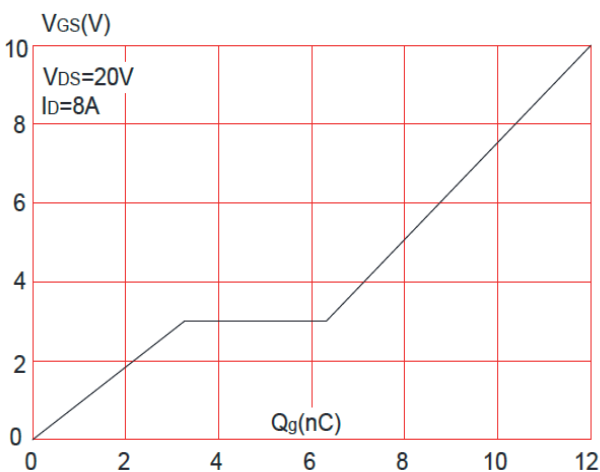
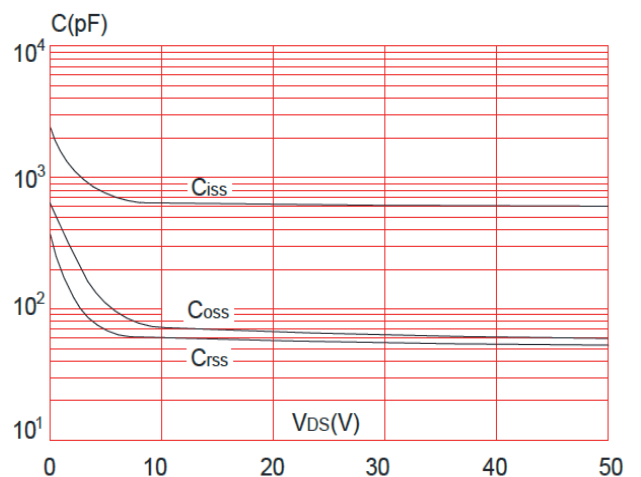

Figure 6: Capacitance Characteristics



Typical Performance Characteristics

Figure 7: Normalized Breakdown Voltage

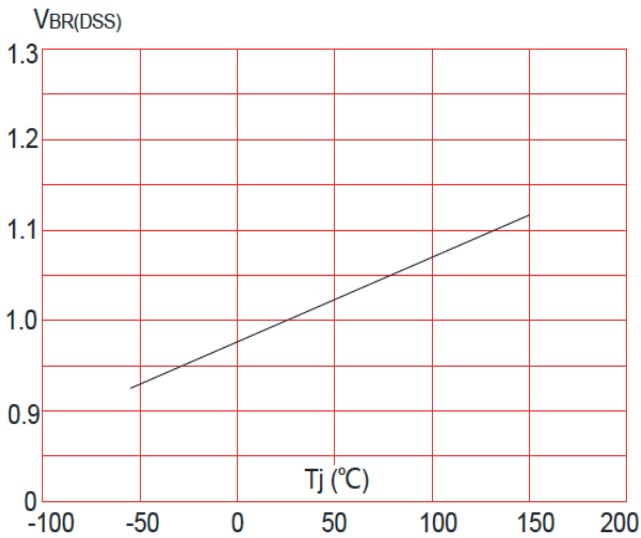

Figure 8: Normalized on Resistance vs. Junction Temperature

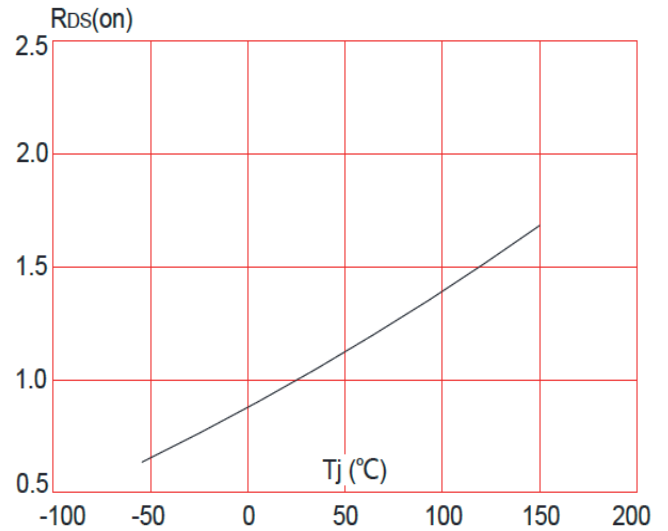

Figure 9: Maximum Safe Operating Area

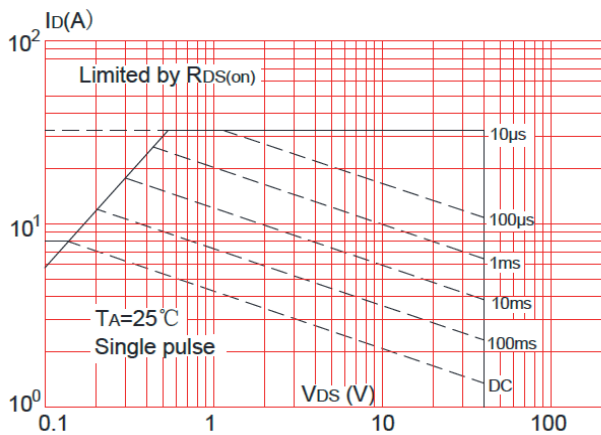

Figure 10: Maximum Continuous Drain Current vs. Ambient Temperature

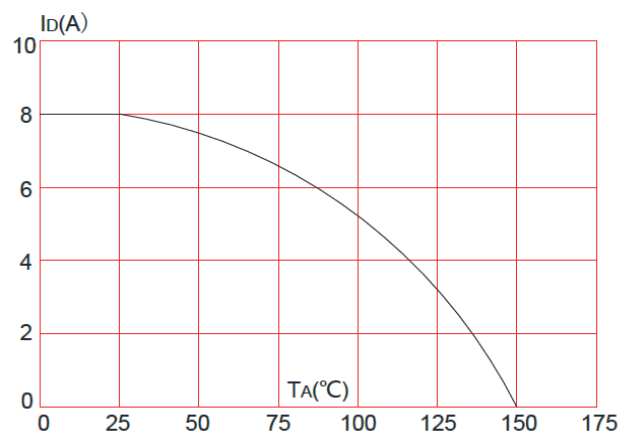
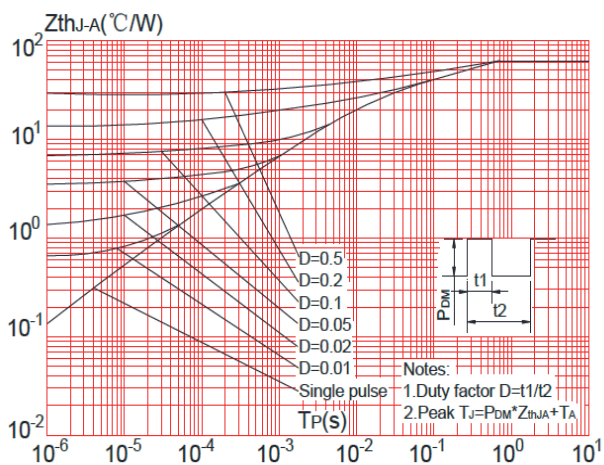
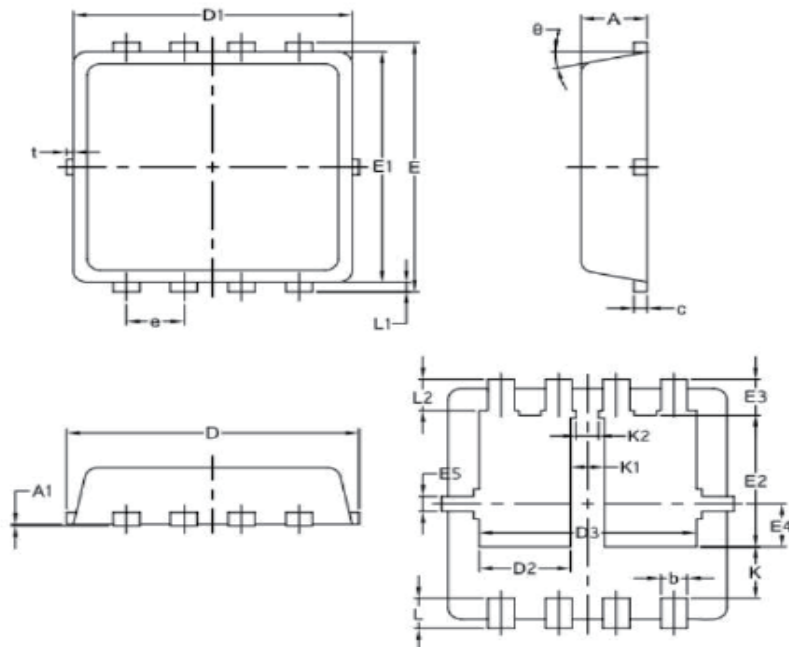

Figure.11: Maximum Effective Transient Thermal Impedance



Package Mechanical Data-PDFN3x3-8L-D-Type A



SYMBOL	COMMON		
	MM		
	MIN	NOM	MAX
A	0.70	0.75	0.85
A1	/	/	0.05
b	0.25	0.30	0.39
c	0.14	0.152	0.20
D	3.20	3.30	3.45
D1	3.05	3.15	3.25
D2	0.84	1.04	1.24
D3	2.30	2.45	2.60
E	3.20	3.30	3.40
E1	2.95	3.05	3.15
E2	1.60	1.74	1.90
E3	0.28	0.48	0.65
E4	0.37	0.57	0.77
E5	0.10	0.20	0.30
e	0.60	0.65	0.70
K	0.50	0.69	0.80
K1	0.30	0.38	0.53
K2	0.15	0.25	0.35
L	0.30	0.40	0.50
L1	0.06	0.125	0.20
L2	0.27	0.42	0.57
t	0	0.075	0.13
θ	10°	12°	14°

Package Mechanical Data-PDFN3x3-8L-D-Type B

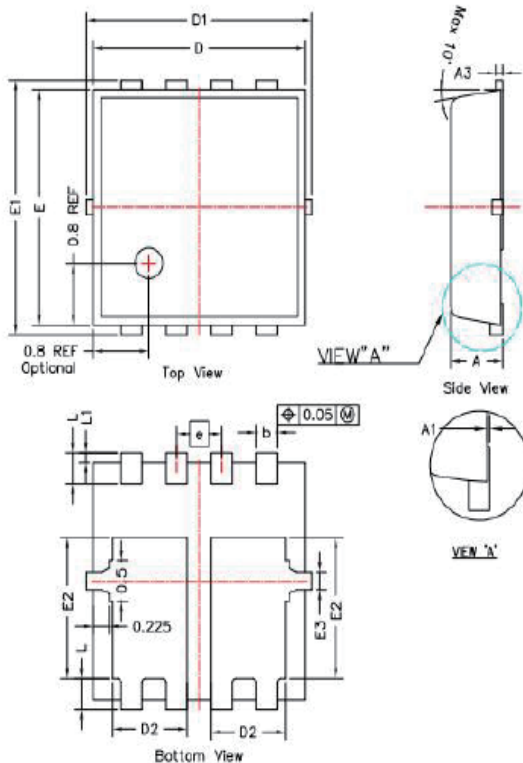

SYMBOLS	DIMENSION IN MM			DIMENSION IN INCHES		
	MIN	NOM	MAX	MIN	NOM	MAX
A	0.700	0.750	0.800	0.028	0.030	0.031
A1	---	---	0.050	---	---	0.002
A3	0.144	0.152	0.202	0.006	0.006	0.008
b	0.250	0.300	0.350	0.010	0.012	0.014
e	0.65 BSC			0.026 BSC		
D	2.950	3.050	3.150	0.116	0.120	0.124
E	2.950	3.050	3.150	0.116	0.120	0.124
D1	3.200	3.300	3.400	0.126	0.130	0.134
E1	3.200	3.300	3.400	0.126	0.130	0.134
D2	0.970	1.070	1.170	0.038	0.042	0.046
E2	1.700	1.800	1.900	0.067	0.071	0.075
E3	0.150	0.200	0.250	0.006	0.008	0.010
L	0.300	0.400	0.500	0.012	0.016	0.020
L1	0.075	0.125	0.175	0.003	0.005	0.007