

FEATURES

- Wide Input Voltage from 4.5V to 18V
- Adjustable Output Voltage from 0.6V to 12V
- Support Output:
 - Dual 2.5A Continuous Output Current
 - Single 5A Continuous Current within 3.3V output voltage
- Constant on Time (COT) Control
- Forced Continuous Conduction Mode (FCCM) for Light Load
- Stable with low ESR Ceramic Capacitors
- Junction Temperature Range from -40°C to 125°C
- Internal Soft-Start time of 2.8ms
- Power Good (PG) Indicator
- Pre-Biased Output Start-Up
- Cycle-by-Cycle Output Current Limit Protection
- Short Circuit and Over-Load Hiccup Protection
- Thermal Shutdown Protection
- BGA-25 (6.25mm×6.25mm×2.42mm) Package
- Pb-Free RoHS Compliant

DESCRIPTION

The M4622 is a dual 2.5A step-down switching mode Power SoC (System on Chip) with integrated power MosFETs, inductor and input decoupling capacitor in BGA-25 package. The input voltage is from 4.5V to 18V.

The M4622 provides high efficiency with COT control mode for fast transient response and good loop stability. It works on FCCM which keeps low output ripple.

The M4622 indicates faults by PG and provides short circuit and over-load hiccup protection and over temperature shutdown protection.

APPLICATIONS

- Optical Module
- PoL Power Supply
- Solid-State and Hard Disk Drives

TYPICAL APPLICATION&EFFICIENCY

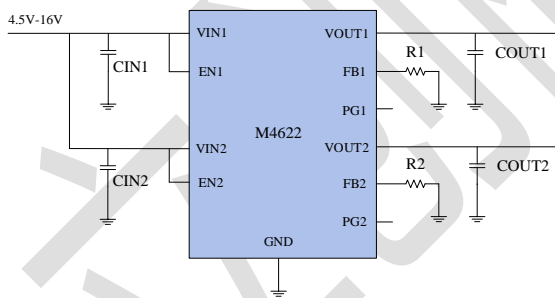

Dual Channel Output

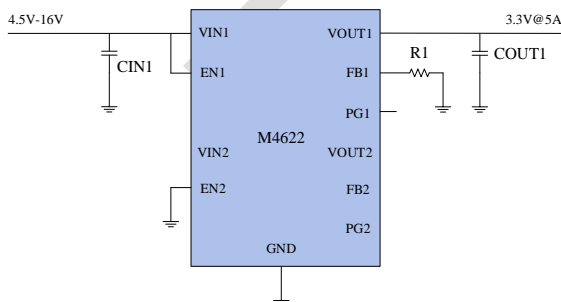

Single Channel Output

($V_{in}=12\text{V}$ for single channel output)

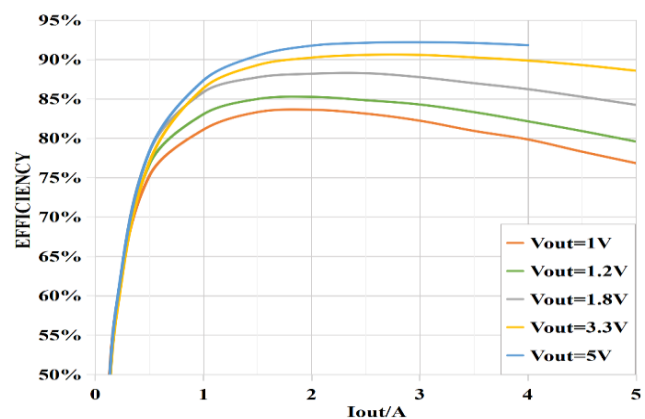



ORDERING INFORMATION

PART NUMBER	TOP MARKING	PACKAGE	MOQ	MSL LEVEL
M4622DBHJ	M4622 YWWLLL	BGA-25 (6.25mm×6.25mm×2.42mm)	260/ Tray	MSL 3

NOTES: Y: Year, WW: Week, LLL: Lot Number.

PACKAGE REFERENCE

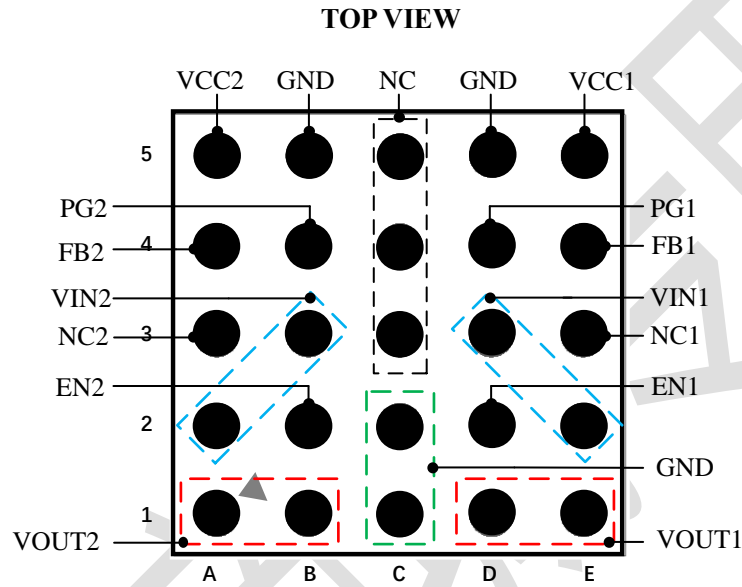



PIN FUNCTIONS

PIN #	NAME	DESCRIPTION
C1, C2, B5, D5	GND	Power Ground.
C3	NC	Not Connected.
C4	NC	Not Connected.
C5	NC	Not Connected.
E3	NC1	Not Connected.
A3	NC2	Not Connected.
D2	EN1	Enable Control of Channel 1. Pull this pin low shuts the channel down. Pull it up high enables the channel.
D4	PG1	Power Good of Channel 1. The output of PG is an open drain, a pull-up resistor to power source is needed if used.
D1, E1	VOUT1	Output Voltage of Channel 1. Connect this pin with the load. Output capacitor is recommended to be placed between VOUT1 and GND.
D3, E2	VIN1	Input Voltage of Channel 1. Input capacitor is recommended to be placed between VIN1 and GND.
E4	FB1	Feedback of Channel 1. Connect this pin to GND with an external feedback bottom resistor to set the output voltage.
E5	VCC1	Not Connected. Internal 5V LDO Output. An output capacitor to AGND has been placed internally.
B2	EN2	Enable Control of Channel 2. Pull this pin low shuts the channel down. Pull it up high enables the channel.
B4	PG2	Power Good of Channel 1. The output of PG is an open drain, a pull-up resistor to power source is needed if used.
A1, B1	VOUT2	Output Voltage of Channel 1. Connect this pin with the load. Output capacitor is recommended to be placed between VOUT2 and GND.
A2, B3	VIN2	Input Voltage of Channel 1. Input capacitor is recommended to be placed between VIN2 and GND.
A4	FB2	Feedback of Channel 1. Connect this pin to GND with an external feedback bottom resistor to set the output voltage.
A5	VCC2	Not Connected. Internal 5V LDO Output. An output capacitor to AGND has been placed internally.



ABSOLUTE MAXIMUM RATINGS

	SYMBOL	MIN	MAX	UNIT
Voltage at Vin	V _{IN}		20	V
Voltage at EN	EN		20	
Voltage at Other Pins		-0.3	6	V
Junction Temperature Range	T _J	-40	125	°C
Storage Temperature Range	T _S	-55	150	°C
Power Dissipation (T _A =+25°C)	P _D ^{Notes 1)}		5	W

RECOMMENDED OPERATING CONDITIONS

	SYMBOL	MIN	MAX	UNIT
Input Voltage Range	V _{IN}	4.5	18	V
Output Voltage Range	V _{OUT}	0.6	12	V
Output Current	I _{OUT}		5	A

THERMAL RESISTANCE

	SYMBOL	MIN	MAX	UNIT
Junction to Ambient	θ _{JA} ^{Notes 2)}		20	°C/W
Junction to Case	θ _{JC} ^{Notes 2)}		1	°C/W

NOTES:

- 1) The maximum allowable continuous power dissipation at any ambient temperature (T_A) is calculated by $P_D(\max) = (T_J(\max) - T_A) / \theta_{JA}$. Exceeding the maximum allowable power dissipation will cause excessive die temperature, and the power module will go into thermal shutdown.
- 2) Measured on EVB, 4-layer PCB 2oZ.



ELECTRICAL CHARACTERISTICS

 $V_{IN}=12V, T_A=25^{\circ}C.$

PARAMETERS	SYMBOL	CONDITION	MIN	TYP	MAX	UNIT
VIN UVLO rising threshold	$V_{IN_UV_R}$	V_{IN} Rising	4.0	4.1	4.3	V
VIN UVLO hysteresis			300	450	600	mV
Shutdown supply current	I_S	$V_{IN}=12V$		1	3	μA
Quiescent supply current	I_Q	No load, $V_{FB} = 0.62V$, no switching		290	325	μA
Enable rising threshold	V_{EN_R}	V_{EN} Rising	1.3	1.45	1.6	V
Hysteresis			100	200	500	mV
Enable Threshold Hysteresis	R_{EN}		1500	1950	2100	$k\Omega$
VCC regulator	VCC	$V_{IN}>5.2V, I_{VCC}=0\mu A$	4.8	5	5.2	V
Feedback voltage	V_{FB_REF}		591	600	609	mV
Feedback leakage	I_{LK_FB}	$V_{EN} = 0V, V_{FB} = 0.6V$			0.1	μA
Low-side Valley Current limit	I_{LIM_LS}		5.5	6.7	7.5	A
Oscillator frequency	F_{SW}		480	560	640	kHz
Soft-start time	T_{SS}	V_{FB} from 10% to 90%	2	2.7	3.5	ms
Power Good	PG_{OVP_R}	Output OVP rising threshold	110%	115%	120%	V_{FB}
	PG_{OVP_F}	Output OVP falling threshold	100%	105%	110%	V_{FB}
	PG_{UVP_F}	UVP threshold falling threshold	70%	75%	80%	V_{FB}
	PG_{UVP_R}	UVP threshold rising threshold	75%	80%	85%	V_{FB}
Output OVP threshold	V_{OVP}	V_{FB} in respect to V_{FB_REF}	110	115	120	%
		hysteresis		10		%
UVP threshold threshold	V_{UVP}	V_{FB} in respect to V_{FB_REF}		80		%
		hysteresis		10		%
Thermal shutdown threshold				160		$^{\circ}C$
OTP hysteresis				20		$^{\circ}C$



TYPICAL PERFORMANCE CHARACTERISTICS

$V_{IN}=12V$, $T_A=25^\circ C$, $F_{SW}=600kHz$, $V_{OUT}=1.2V$, unless otherwise noted.

Line Regulation

$V_{OUT}=0.85V/1V/1.2V/1.8V/3.3V$, $I_{OUT}=3A$,

$V_{IN}=4.5\sim 18V$

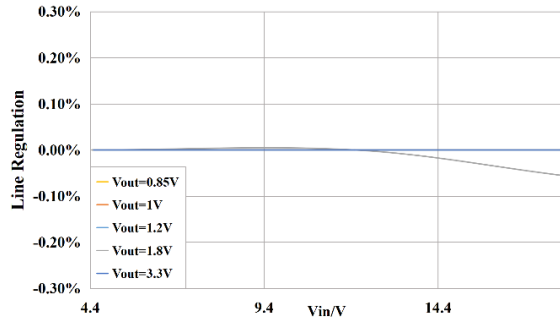

Load Regulation

$V_{IN}=12V$, $V_{OUT}=0.85V/1V/1.2V/1.8V/3.3V$,

$I_{OUT}=0\sim 3A$

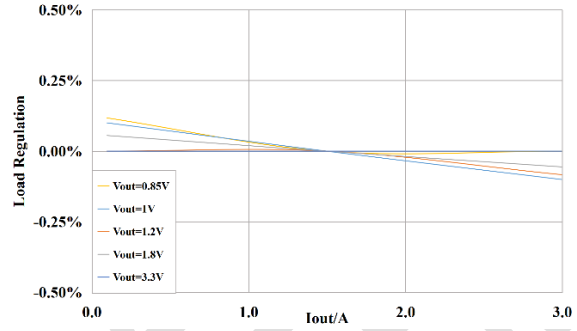

Efficiency

$V_{IN}=12V$, $V_{OUT}=1V/1.2V/1.8V/3.3V/5V$,

$I_{OUT}=0\sim 5A$

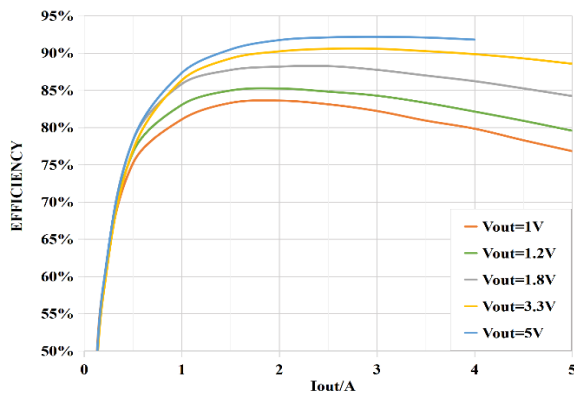

Efficiency

$V_{IN}=5V$, $V_{OUT}=0.85V/1V/1.2V/1.8V/3.3V$,

$I_{OUT}=0\sim 5A$

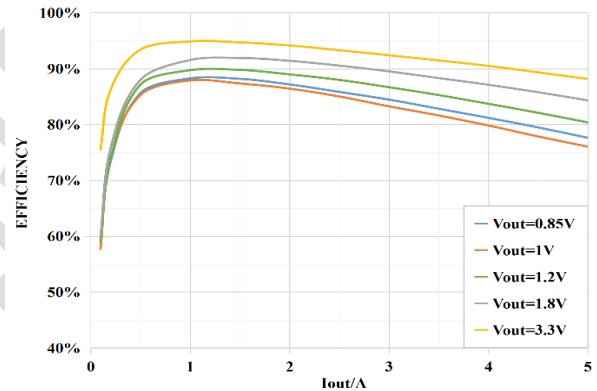



TYPICAL PERFORMANCE CHARACTERISTICS (continued)

$V_{IN}=12V$, $T_A=25^\circ C$, $F_{SW}=600kHz$, $V_{OUT}=1.2V$, unless otherwise noted.

VIN Start-up

$I_{OUT}=0A$

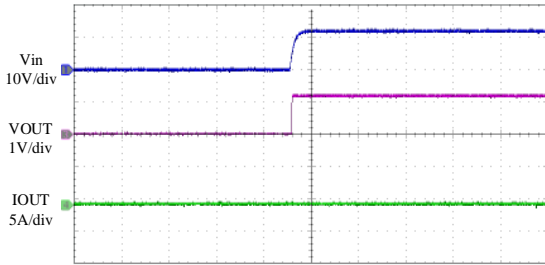

100ms/div

VIN Start-up

$I_{OUT}=5A$

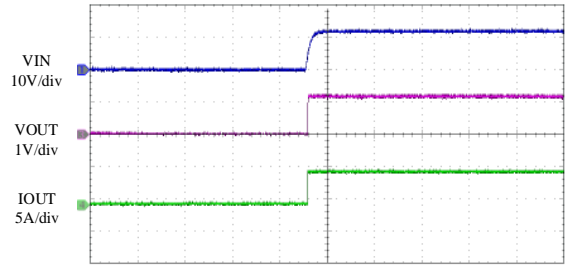

100ms/div

VIN Shutdown

$I_{OUT}=0A$

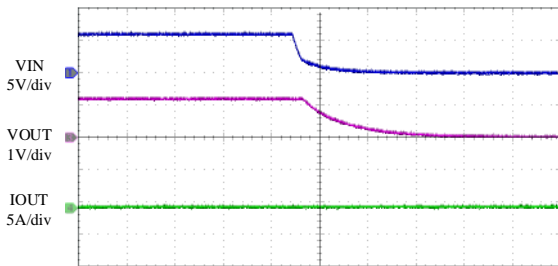

400ms/div

VIN Shutdown

$I_{OUT}=5A$

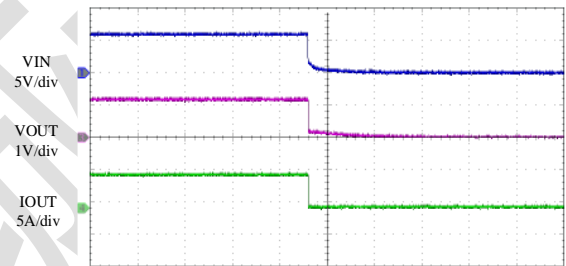

400ms/div

EN Start-up

$I_{OUT}=0A$

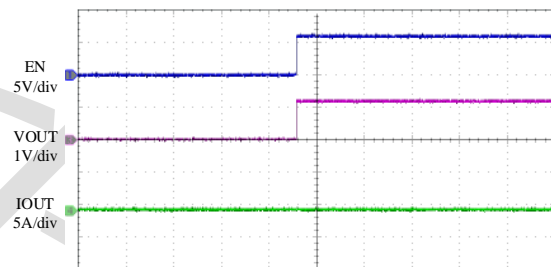

1s/div

EN Start-up

$I_{OUT}=5A$

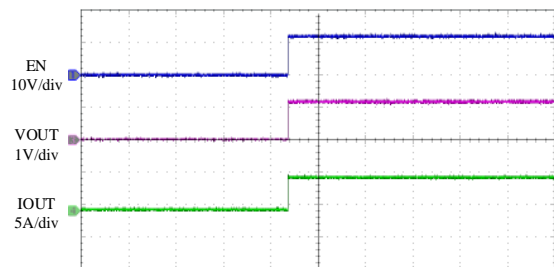

1s/div



TYPICAL PERFORMANCE CHARACTERISTICS (continued)

$V_{IN}=12V$, $T_A=25^\circ C$, $F_{sw}600kHz$, $V_{OUT}=1.2V$, unless otherwise noted.

EN Shutdown

$I_{OUT}=0A$

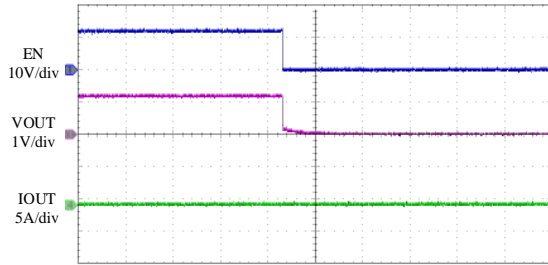

1s/div

EN Shutdown

$I_{OUT}=5A$

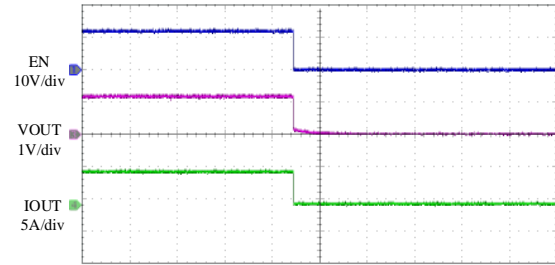

1s/div

SCP Entry

$I_{OUT}=0A$

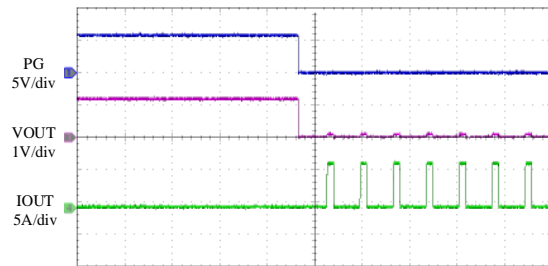

40ms/div

SCP Entry

$I_{OUT}=5A$

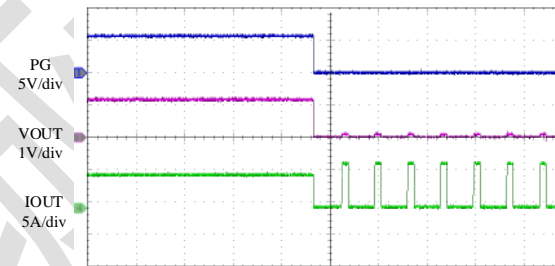

40ms/div

SCP Recovery

$I_{OUT}=0A$

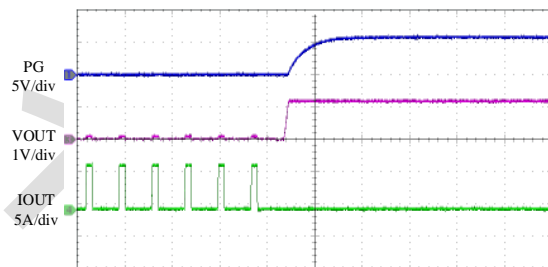

40ms/div

SCP Recovery

$I_{OUT}=5A$

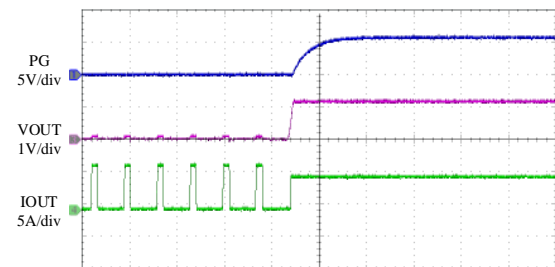

40ms/div



TYPICAL PERFORMANCE CHARACTERISTICS (continued)

$V_{IN}=12V$, $T_A=25^{\circ}C$, $F_{SW}=600kHz$, $V_{OUT}=1.2V$, unless otherwise noted.

VOUT Ripple

$I_{OUT}=0A$

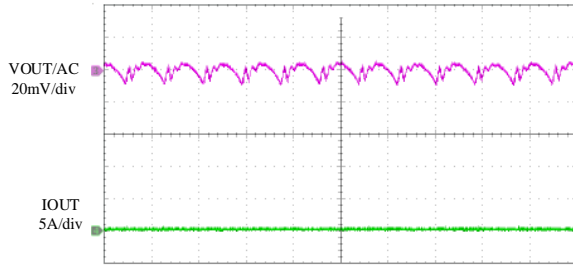

2us/div

VOUT Ripple

$I_{OUT}=5A$

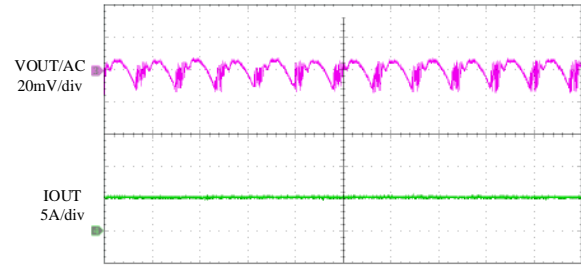

2us/div

Load Transient

$I_{OUT}=0A$ to 2.5A, 1A/ μs

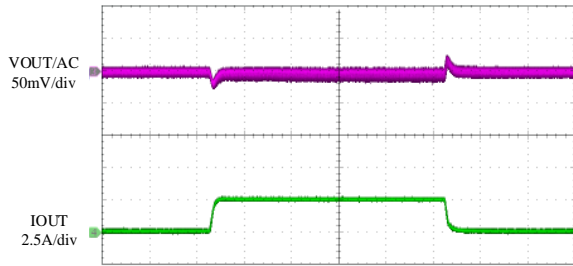

100 μs /div

Load Transient

$I_{OUT}=0A$ to 5A, 1A/ μs

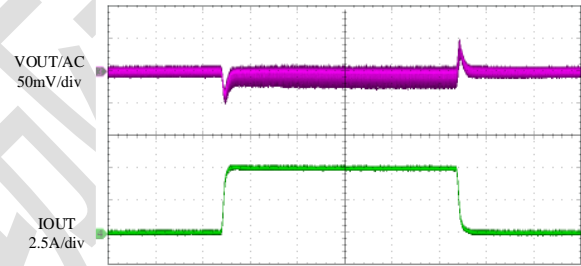

100 μs /div

Load Transient

$I_{OUT}=2.5A$ to 5A, 1A/ μs

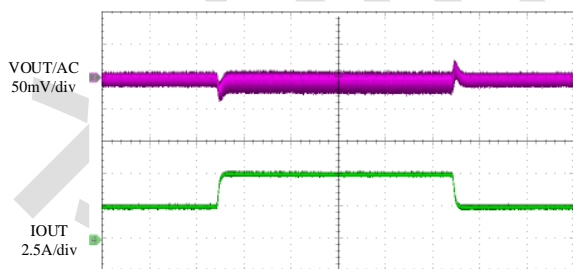

100 μs /div



OPERATION

The M4622 is a dual 2.5A step-down switching mode Power SoC (System on Chip) with integrated power MosFETs, inductor and input decoupling capacitor in BGA-25 package. Only FB resistors, input and output capacitors are needed to complete the design over 4.5V to 18V input voltage range. The M4622 supports output voltage of 0.6V to 12V with the fixed switching frequency of 600kHz.

M4622 works on COT control mode that offers excellent transient response over the wide range of input voltage. M4622 operates in Forced Continuous Conduction Mode (FCCM) which keeps low output ripple. The soft start time of M4622 is 2.8ms internally. Fully integrated protection features include OCP, UVP, OTP and all these faults can be indicated by PG. The protection function details are shown below.

VIN Under-Voltage Lockout (VIN UVLO)

VIN Under-voltage lockout (VIN UVLO) protects the chip from operating at an insufficient VIN voltage. The M4622 VIN UVLO comparator monitors the VIN voltage. The VIN UVLO rising threshold is about 4.1V, while its falling threshold is consistently 3.6V.

Pre-Bias Start-Up

M4622 is designed for monotonic start-up into pre-biased loads. If the output is pre-biased to a certain voltage during start-up, the BST voltage is refreshed and charged, and the voltage on the soft start is charged as well. If the BST voltage exceeds its rising threshold voltage and the soft-start voltage exceeds the sensed output voltage at FB, the part works normally.

Over-Current Protection (OCP)

M4622 has both valley current-limit control and peak current limit control. During low side MosFET on, the inductor current is monitored. When the sensed inductor

current reaches the valley current limit, the low side MosFET limit comparator. The device enters overcurrent protection (OCP) mode, and the high side MosFET waits until the valley current limit disappears before turning on again. During the high side MosFET on period, the inductor current is compared with the peak current-limit. If the peak current limit is triggered, the high side MosFET on pulse will be terminated immediately. The output voltage drops until VFB is below the UVP threshold. Once FB UVP is triggered, M4622 enters hiccup mode to restart the part periodically.

Output Over-Voltage Protection (OVP)

M4622 monitors a resistor-divided V_{FB} to detect over or under-voltage. When V_{FB} becomes higher than 115% of the target voltage, the over-voltage protection (OVP) comparator output goes to high, and the circuit will turn on low side MosFET to discharge the output. Low side MosFET will be turned off until the negative current limit is triggered then low side MosFET will remain off for 5 μ s to turn on again. IC will repeat above process until the output OVP condition is removed.

Under-Voltage Protection (UVP)

When VFB drops below 75% of VREF, the UVP comparator output goes to high, and M4622 enters the hiccup protection.

Thermal Shutdown

The junction temperature of M4622 is monitored internally. If the junction temperature exceeds the threshold value (typically 160°C), the converter shuts off. This is a non-latched protection. The device will power up again when the junction temperature drops below typically 140°C.



USER GUIDE

Output Voltage

The output voltage is set by the external feedback bottom resistor as the typical application circuit on Page 1. The bottom feedback resistor R_2 can be calculated as:

$$R_2 = \frac{60.4}{\frac{V_{OUT}}{V_{FB}} - 1}$$

Table 1 lists the recommended feedback resistor values for common output voltages.

Table 1: FB Resistor Values for Common Output Voltages.

$V_{OUT}(V)$	$R_2(k\Omega)$
0.9	120
1.0	90.1
1.2	60.4
1.5	40
1.8	30
2.5	19
3.3	13.3
5	8.2

Input Capacitor Selection

The input current of the step-down converter is discontinuous with sharp edges, therefore, placing input filter capacitors is necessary. For better performance, low ESR ceramic capacitor with X5R or X7R dielectrics are highly recommended because of their lowest temperature variations. The RMS current of the input capacitor is calculated:

$$I_{CIN_RMS} = I_{OUT} \sqrt{D(1-D)}$$

in which D is the Duty Cycle and when the current is continuous, $D = V_{OUT}/V_{IN}$; I_{OUT} is the output load current. As the equation above, when D is 0.5, the highest RMS current is approximately:

$$I_{CIN_RMS} = \frac{1}{2} \times I_{OUT}$$

So, it is recommended to choose the capacitors with the RMS current rating higher than $1/2 I_{OUT}$.

The power dissipation on the input capacitors can be estimated with the RMS current and the ESR.

Electrolytic or tantalum capacitors can also be used. The input voltage ripple caused by the capacitor can be calculated as:

$$\Delta V_{CIN} = \frac{I_{OUT}}{F_{SW} \cdot C_{IN}} \cdot \frac{V_{OUT}}{V_{IN}} \cdot \left(1 - \frac{V_{OUT}}{V_{IN}}\right)$$

in which, F_{SW} is switching frequency.

Output Capacitor Selection

Output capacitors are required to keep output voltage stable. To minimize the output voltage ripple, low ESR ceramic capacitors should be used. The output voltage ripple can be estimated as:

$$\Delta V_{OUT} = \frac{V_{OUT}}{8F_{SW}^2 C_{OUT} L} \cdot \left(1 - \frac{V_{OUT}}{V_{IN}}\right)$$

In which, L is the inductor fixed at $1\mu H$ internally.

If electrolytic or tantalum capacitors are used, the ESR will dominate the output voltage ripple as:

$$\Delta V_{OUT} = R_{ESR} \cdot \frac{V_{OUT}}{F_{SW} L} \cdot \left(1 - \frac{V_{OUT}}{V_{IN}}\right)$$

Enable Control

The EN resistor has been placed internally, so EN can be pull up to V_{in} directly. M4622 can be enabled by pulling the EN pin to above 1.25V and will be disabled if the EN pin is below 1V.

Power Good Indicator

The M4622 has power good indication function, it is an open-drain output. When the output voltage within 85% to 105% of the target value, the PG internal pulled-down circuits is disabled, PG signal is pulled-high by VCC or other external voltage source. When the output voltage falls below 80%, or rises above 115% of the target value, PG signal will be pulled down internally.

Recommend to connect a $10k\Omega$ - $100k\Omega$ value resistor from PG to VCC.

PCB Layout Guide

To optimize the electrical and thermal performance, some PCB layout guidelines should be considered as below:

1. Use wide trace for the high current paths and keep it as short as possible. It helps to minimize the PCB conduction loss and thermal stress.



2. Place the input decoupling capacitor close to VIN and GND.
3. Connect all feedback network to FB shortly.

立创商城



TYPICAL APPLICATION

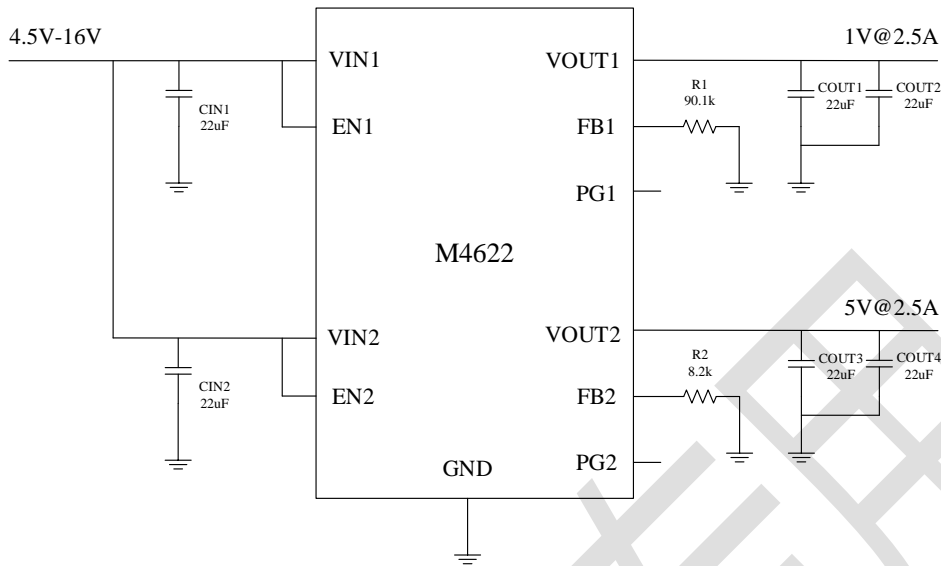

Figure 2. Typical Application Circuits of M4622 for 1V5V@2.5A Output

Table 2: Reference Design(Vin=12V)

VOUT	CIN	COUT	Target Vout Ripple	R1/R2	Io
5.0V	1×22uF	2×22uF	75mV	8.2kΩ	4A
3.3V	1×22uF	2×22uF	50mV	13.4kΩ	5A
1.8V	1×22uF	2×22uF	30mV	30.2kΩ	5A
1.2V	1×22uF	2×22uF	25mV	60.4kΩ	5A
1.0V	1×22uF	2×22uF	20mV	90.1kΩ	5A



PACKAGE INFORMATION

BGA-25 (6.25mm×6.25mm×2.42mm) Package

TOP VIEW

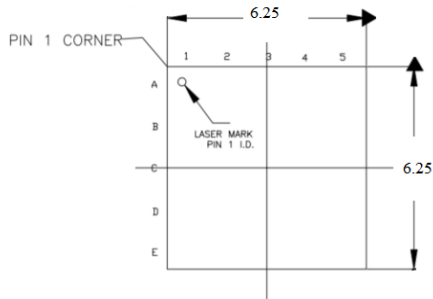

SIDE VIEW

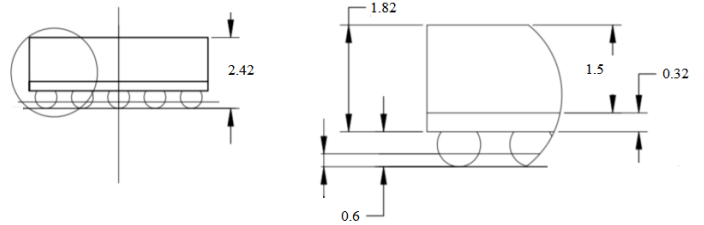

BOTTOM VIEW

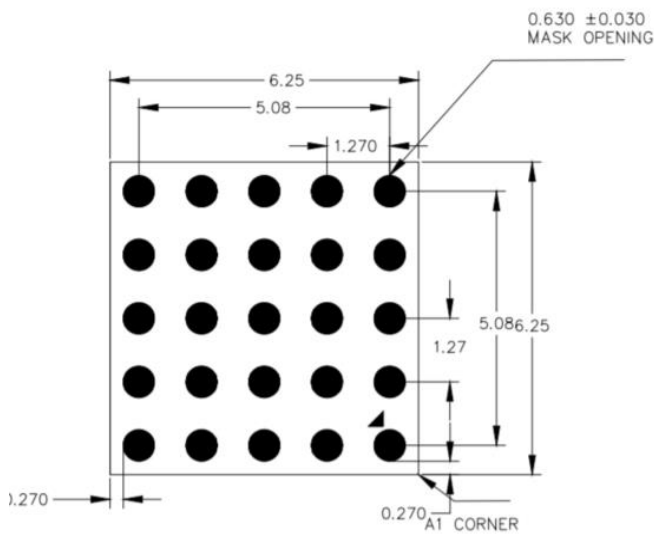

RECOMMENDED LAND PATTERN

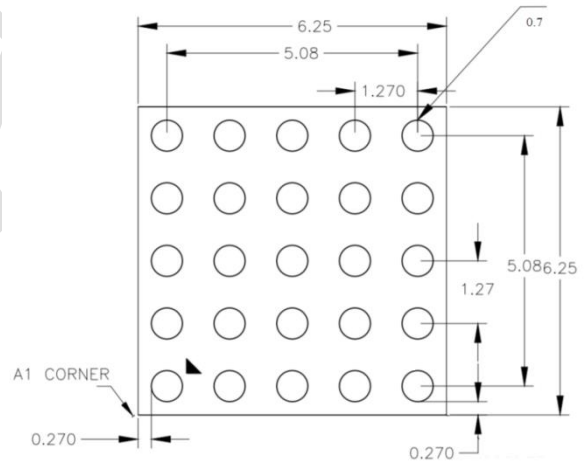

**M4622 VS LXX4622 PIN CONNECTION RECOMMENDATIONS**

	M4644		LXX4622		兼容措施
	引脚	连接方式	引脚	连接方式	
C5	NC	NC	MODE/SYNC	GND/VCC/CLOCK	可直接兼容
C4	NC	NC	FREQ	R	可直接兼容
C3	NC	NC	INTVCC	NC	可直接兼容
A5,E5	VCC1,2	NC	COMP1,2	NC 或外接 R/C	不接阻容
A3,E3	NC1,2	NC	TRACK/SS1,2	C	不接阻容