



Features

- $V_{DS} = 30V, I_D = 5.8A$   
 $R_{DS(ON)} < 31m\Omega @ V_{GS}=10V$   
 $R_{DS(ON)} < 43m\Omega @ V_{GS}=4.5V$
- High Power and current handing capability
- Lead free product is acquired
- Surface mount package

Typical Applications

- Load switch
- PWM application

Shipping Quantity

- 3000pcs / Tape & Reel



Marking:A49T

Circuit Diagram

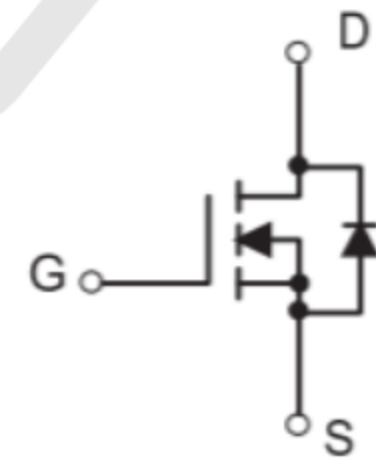

N-MOS

Absolute Maximum Ratings ( $T_A=25^\circ C$  unless otherwise noted)

Parameter	Symbol	Limit	Unit
Drain-Source Voltage	$V_{DS}$	30	V
Gate-Source Voltage	$V_{GS}$	$\pm 20$	V
Drain Current-Continuous	$I_D$	5.8	A
Drain Current-Pulsed <sup>(Note 1)</sup>	$I_{DM}$	20	A
Maximum Power Dissipation	$P_D$	1.4	W
Operating Junction and Storage Temperature Range	$T_J, T_{STG}$	-55 To 150	$^\circ C$

Thermal Characteristic

Thermal Resistance, Junction-to-Ambient <sup>(Note 2)</sup>	$R_{\theta JA}$	89	$^\circ C/W$
---	-----------------	----	--------------

Electrical Characteristics ( $T_A=25^\circ\text{C}$  unless otherwise noted)

Parameter	Symbol	Condition	Min	Typ	Max	Unit
<b>Off Characteristics</b>						
Drain-Source Breakdown Voltage	$BV_{DSS}$	$V_{GS}=0V, I_D=250\mu A$	30	33	-	V
Zero Gate Voltage Drain Current	$I_{DSS}$	$V_{DS}=30V, V_{GS}=0V$	-	-	1	$\mu A$
Gate-Body Leakage Current	$I_{GSS}$	$V_{GS}=\pm 20V, V_{DS}=0V$	-	-	$\pm 100$	nA
<b>On Characteristics</b> (Note 3)						
Gate Threshold Voltage	$V_{GS(th)}$	$V_{DS}=V_{GS}, I_D=250\mu A$	1.2	1.6	2.4	V
Drain-Source On-State Resistance	$R_{DS(on)}$	$V_{GS}=10V, I_D=5A$	-	25.5	31	m $\Omega$
		$V_{GS}=4.5V, I_D=4A$	-	36	43	m $\Omega$
Forward Transconductance	$g_{FS}$	$V_{DS}=5V, I_D=5A$	-	15	-	S
<b>Dynamic Characteristics</b> (Note 4)						
Input Capacitance	$C_{iss}$	$V_{DS}=15V, V_{GS}=0V,$ $F=1.0MHz$	-	255	-	PF
Output Capacitance	$C_{oss}$		-	45	-	PF
Reverse Transfer Capacitance	$C_{rss}$		-	35	-	PF
<b>Switching Characteristics</b> (Note 4)						
Turn-on Delay Time	$t_{d(on)}$	$V_{DD}=15V, R_L=3\Omega$ $V_{GS}=10V, R_{GEN}=3\Omega$	-	4.5	-	nS
Turn-on Rise Time	$t_r$		-	2.5	-	nS
Turn-Off Delay Time	$t_{d(off)}$		-	14.5	-	nS
Turn-Off Fall Time	$t_f$		-	3.5	-	nS
Total Gate Charge	$Q_g$	$V_{DS}=15V, I_D=5A,$ $V_{GS}=10V$	-	5.2	-	nC
Gate-Source Charge	$Q_{gs}$		-	0.85	-	nC
Gate-Drain Charge	$Q_{gd}$		-	1.3	-	nC
<b>Drain-Source Diode Characteristics</b>						
Diode Forward Voltage (Note 3)	$V_{SD}$	$V_{GS}=0V, I_S=5A$	-	-	1.2	V
Diode Forward Current (Note 2)	$I_S$		-	-	5	A



Typical Performance Characteristics ( $T_A=25^\circ\text{C}$  unless otherwise Specified)

[www.sot23.com.tw](http://www.sot23.com.tw)

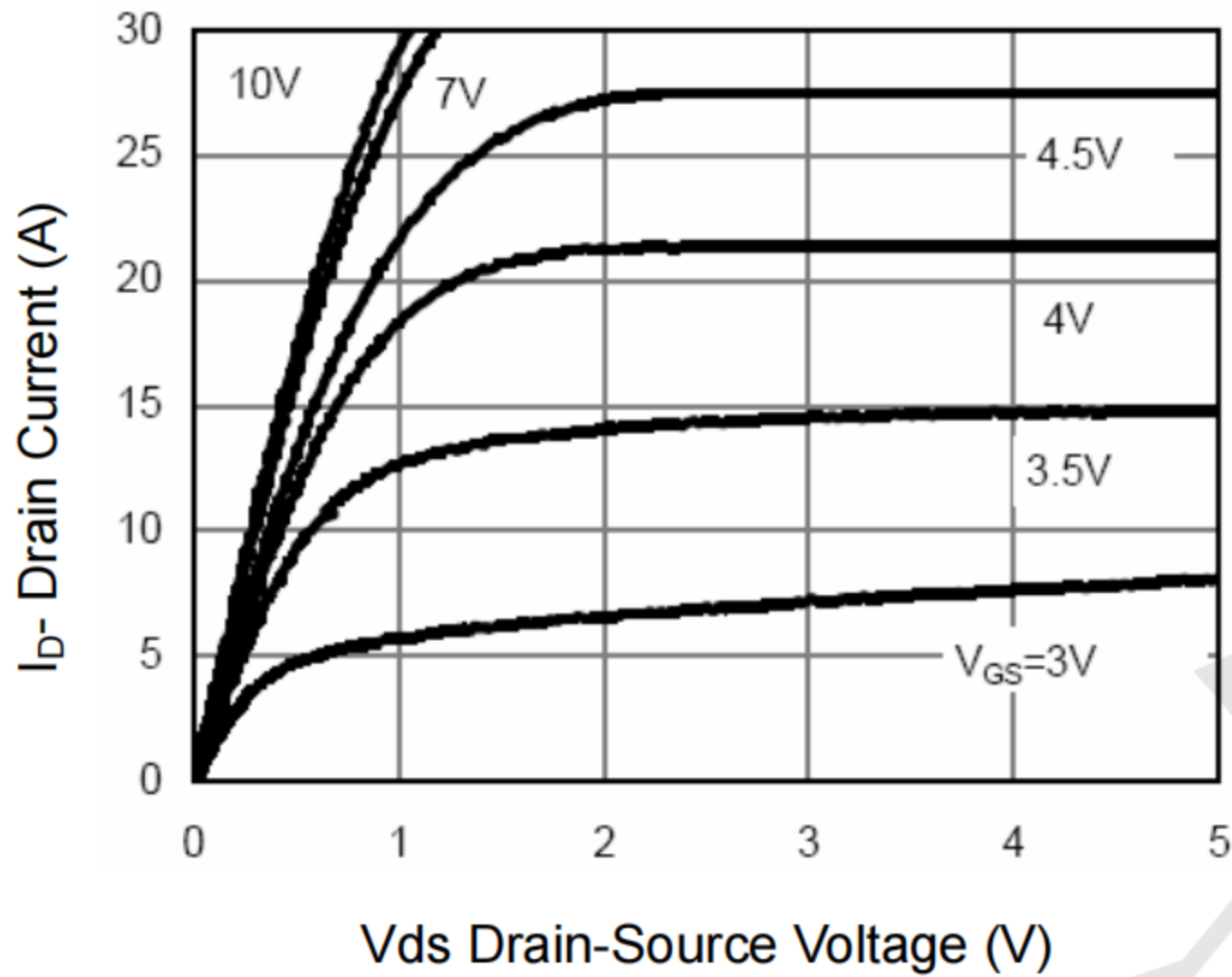

Figure 1 Output Characteristics

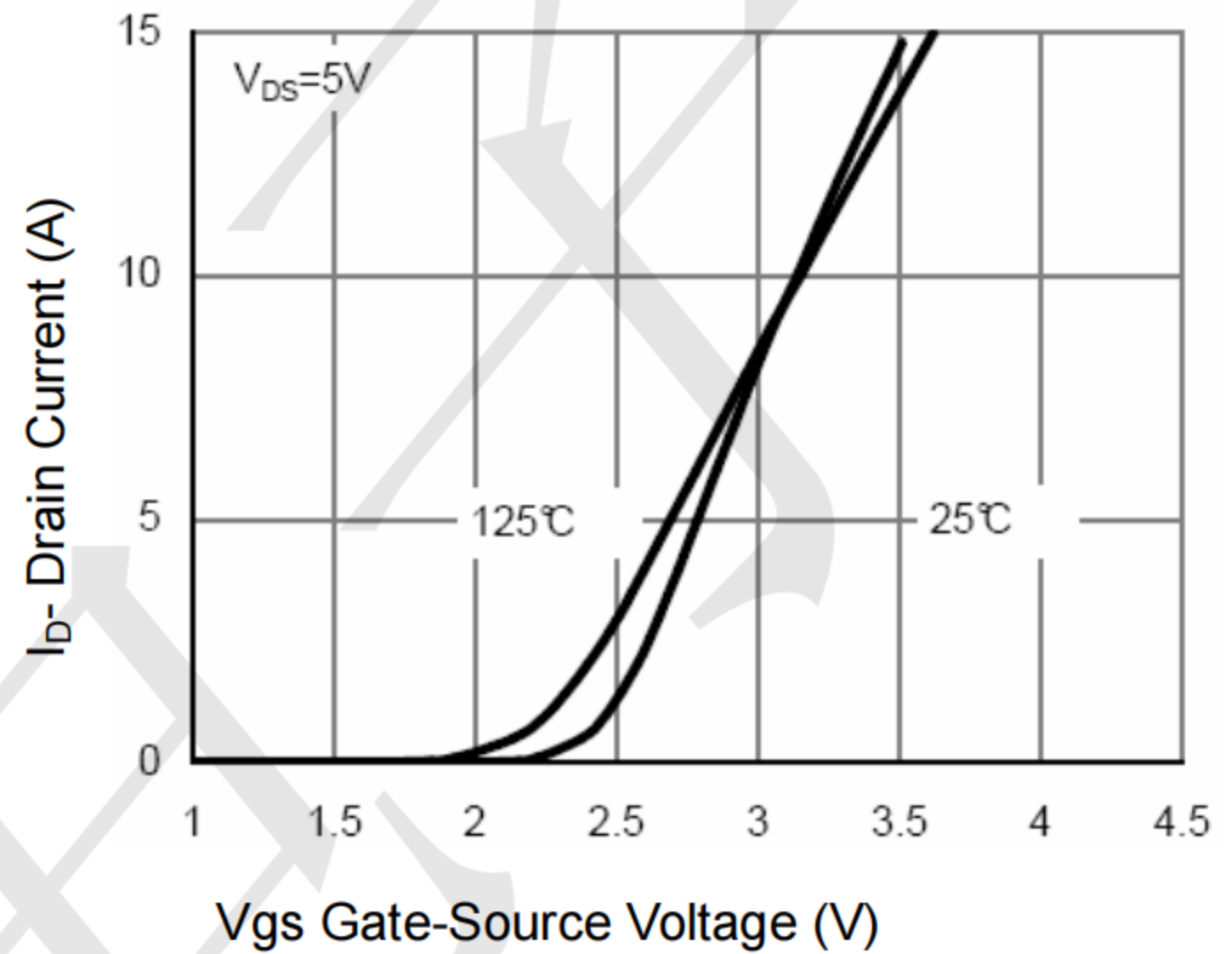

Figure 2 Transfer Characteristics

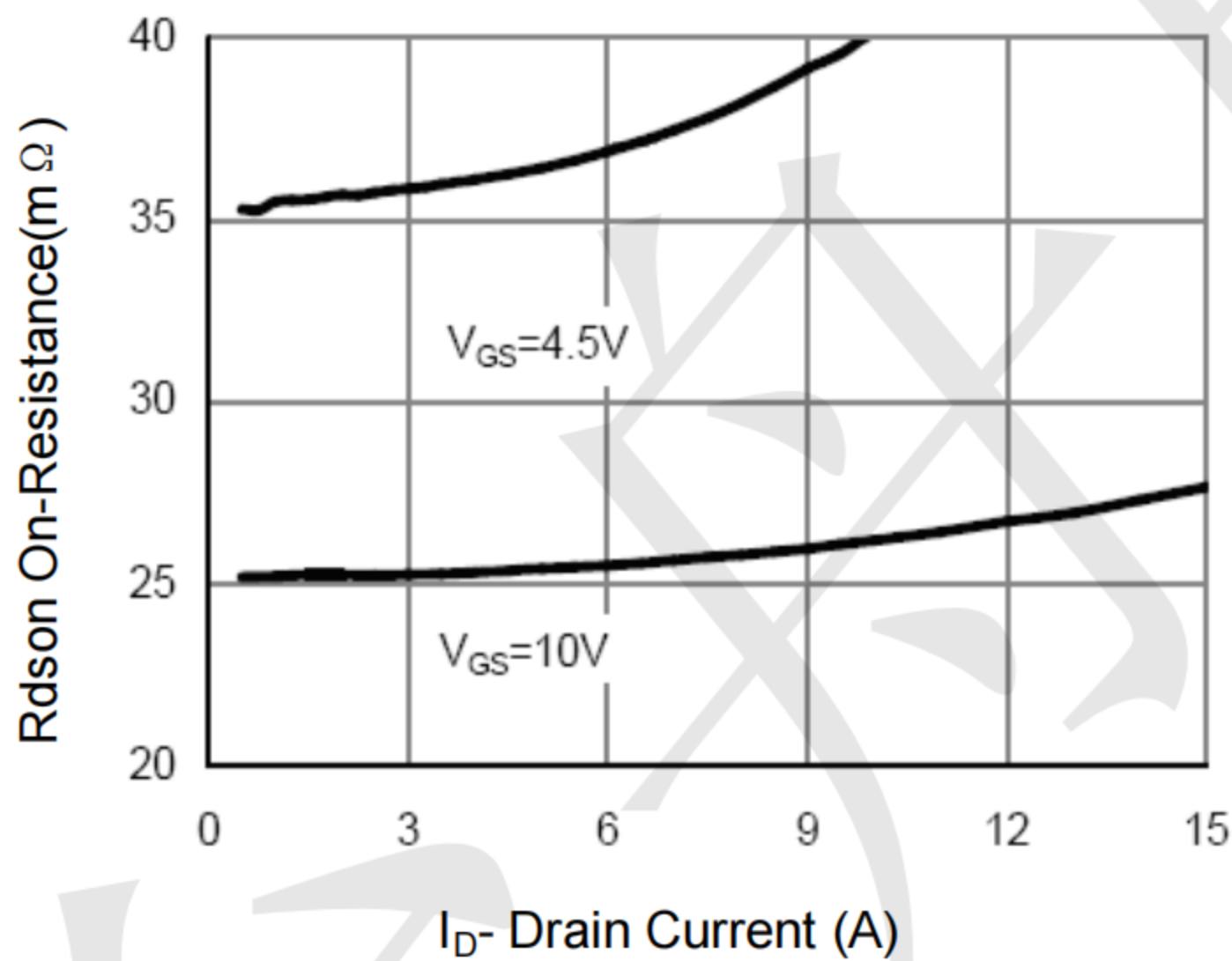

Figure 3 Drain-Source On-Resistance

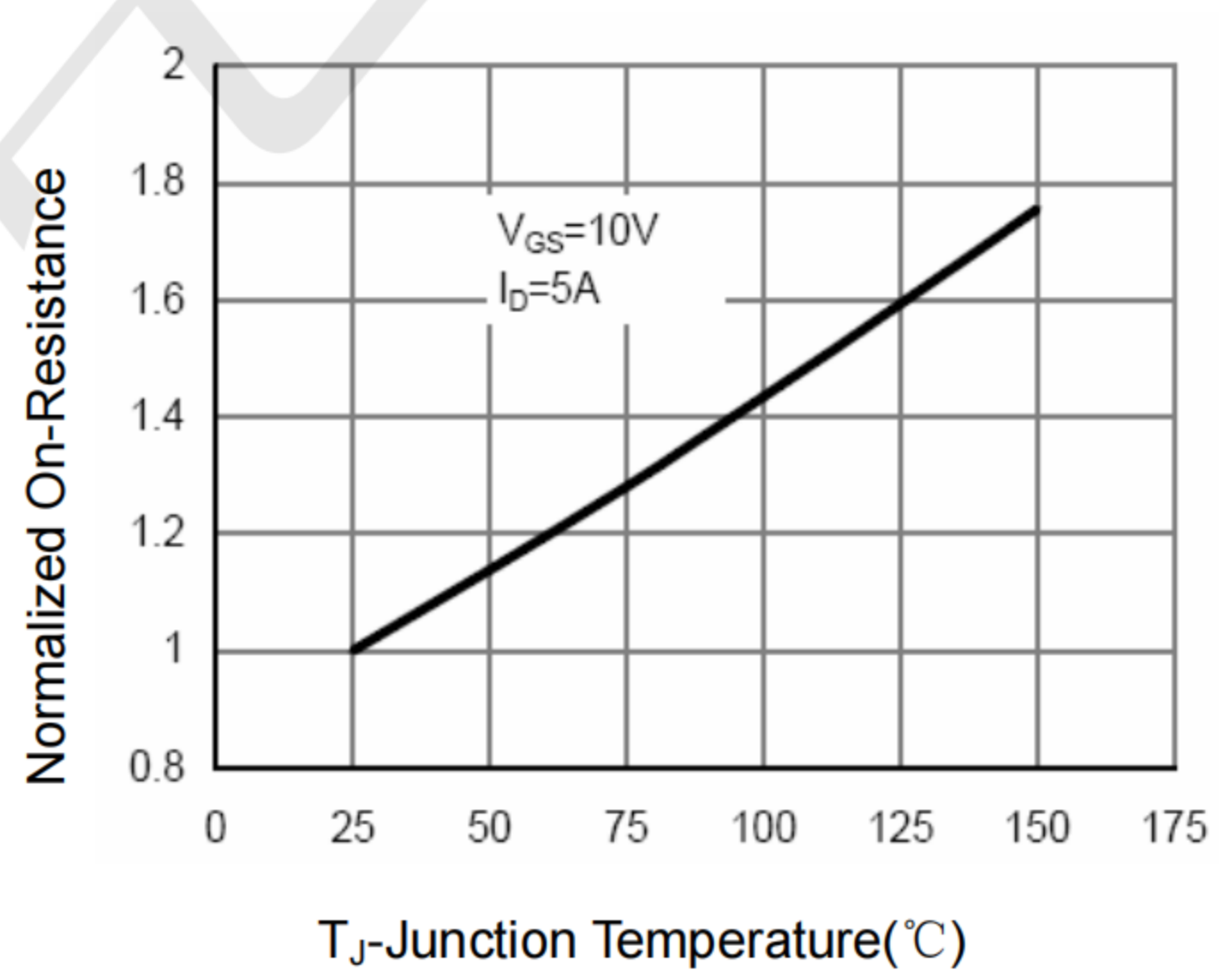

Figure 4 Drain-Source On-Resistance

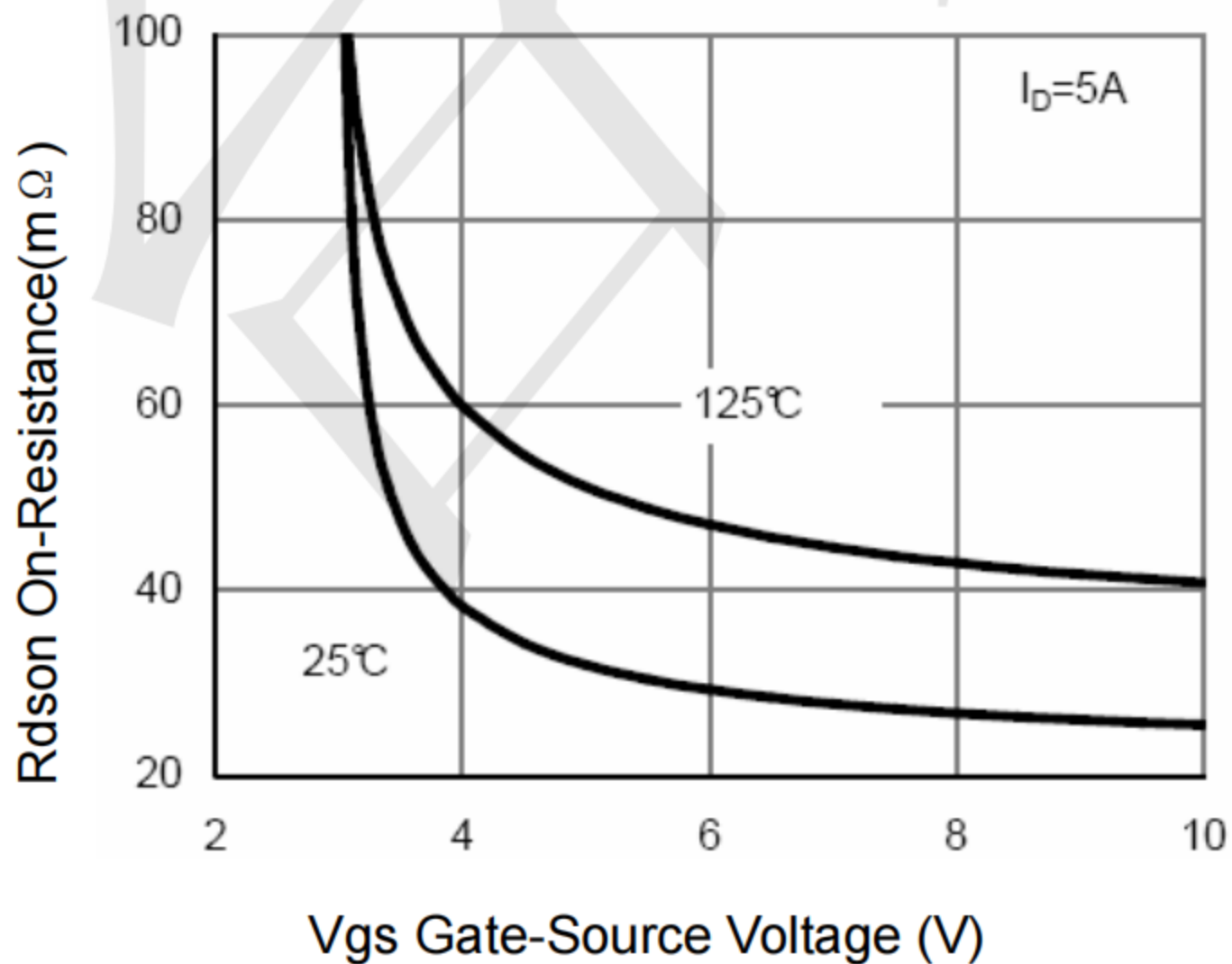

Figure 5 Rdson vs Vgs

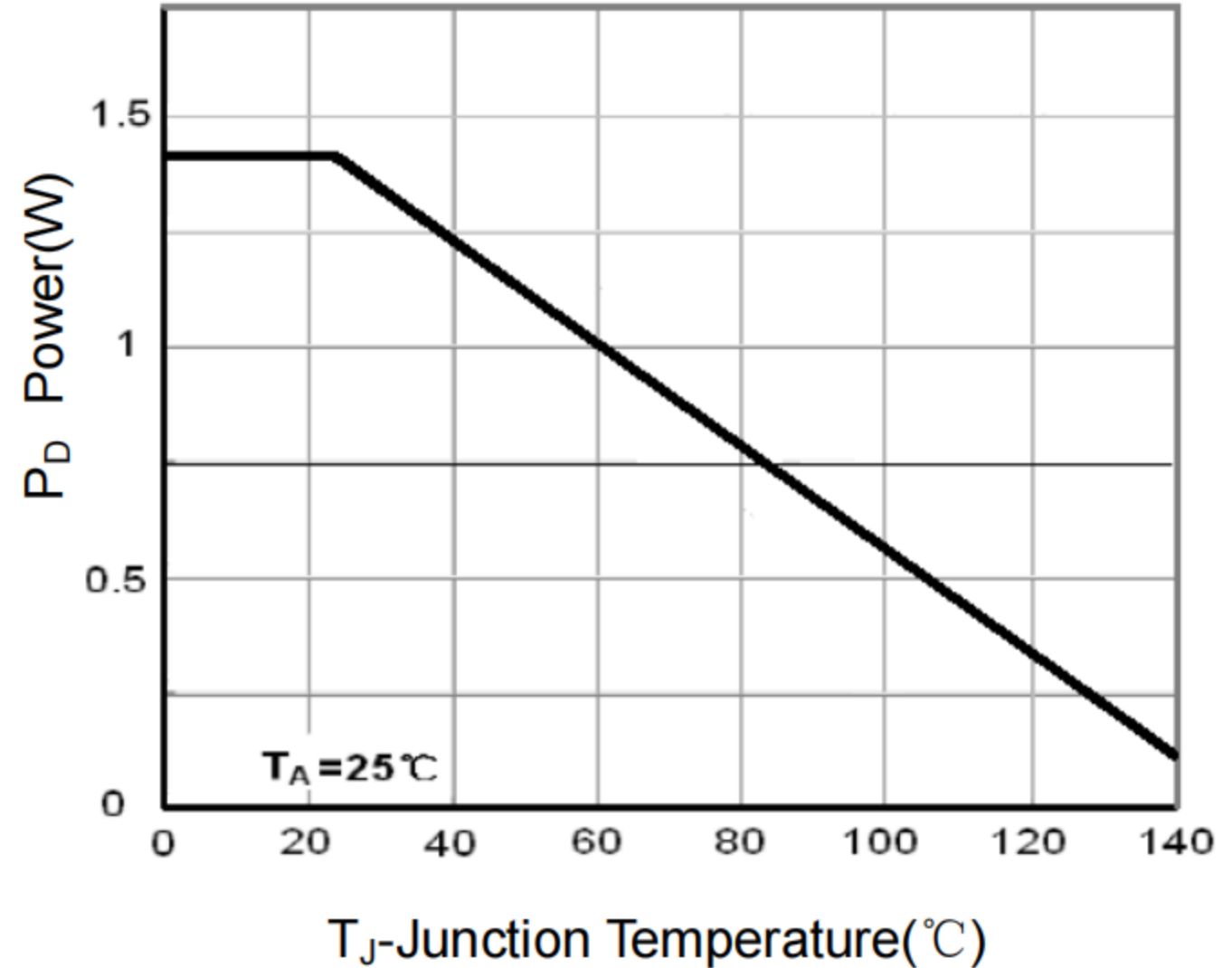

Figure 6 Power Dissipation

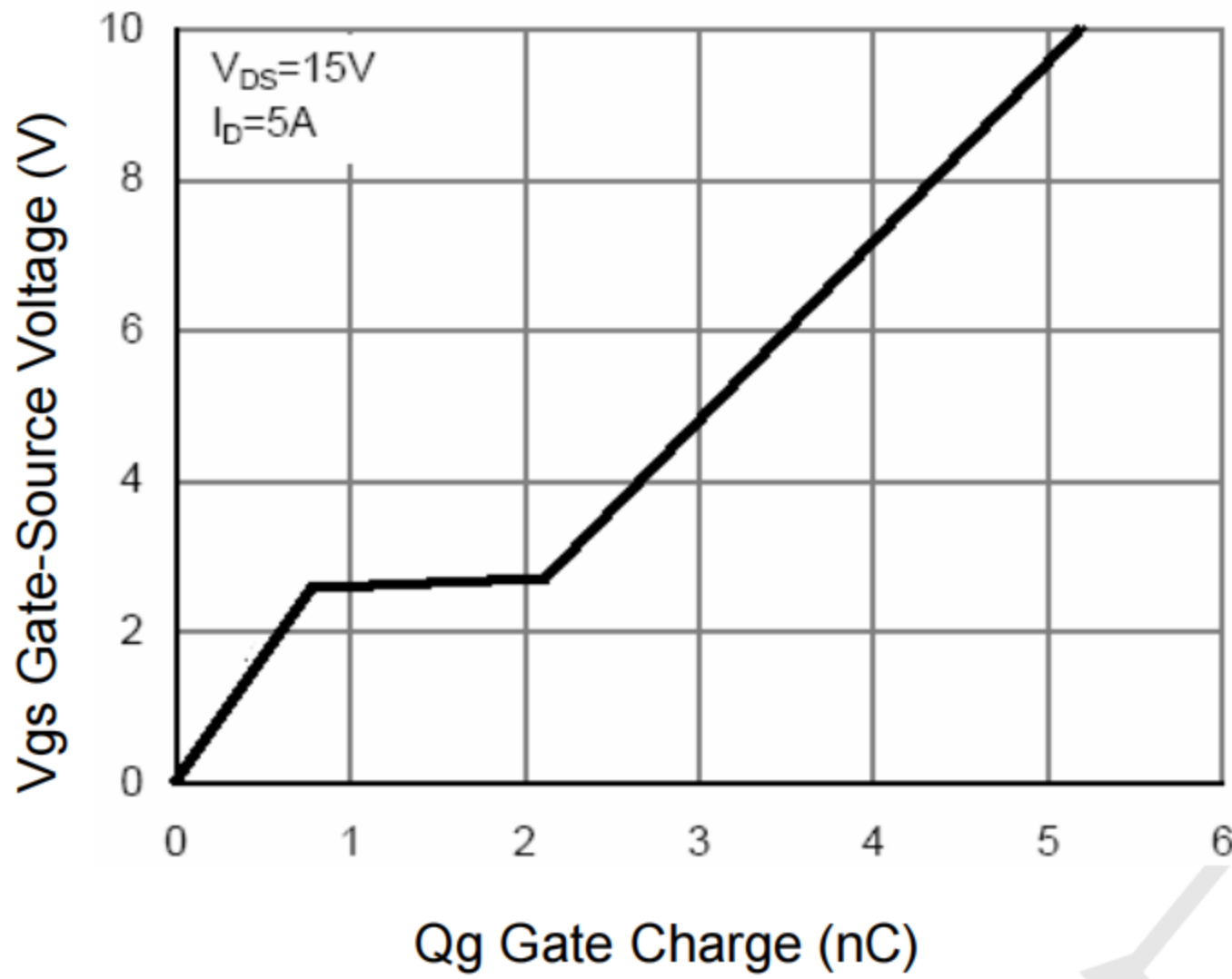

Figure 7 Gate Charge

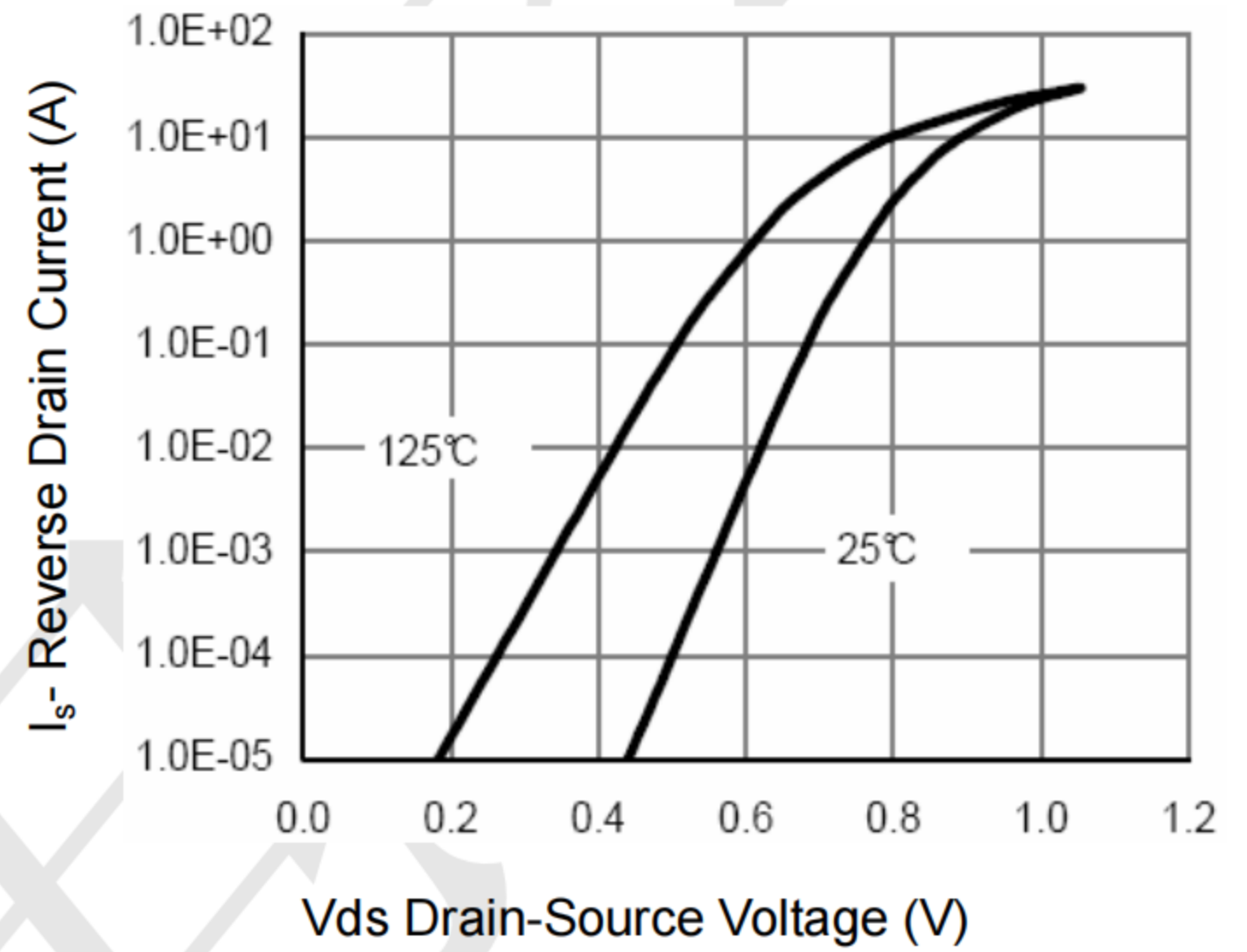

Figure 8 Source- Drain Diode Forward

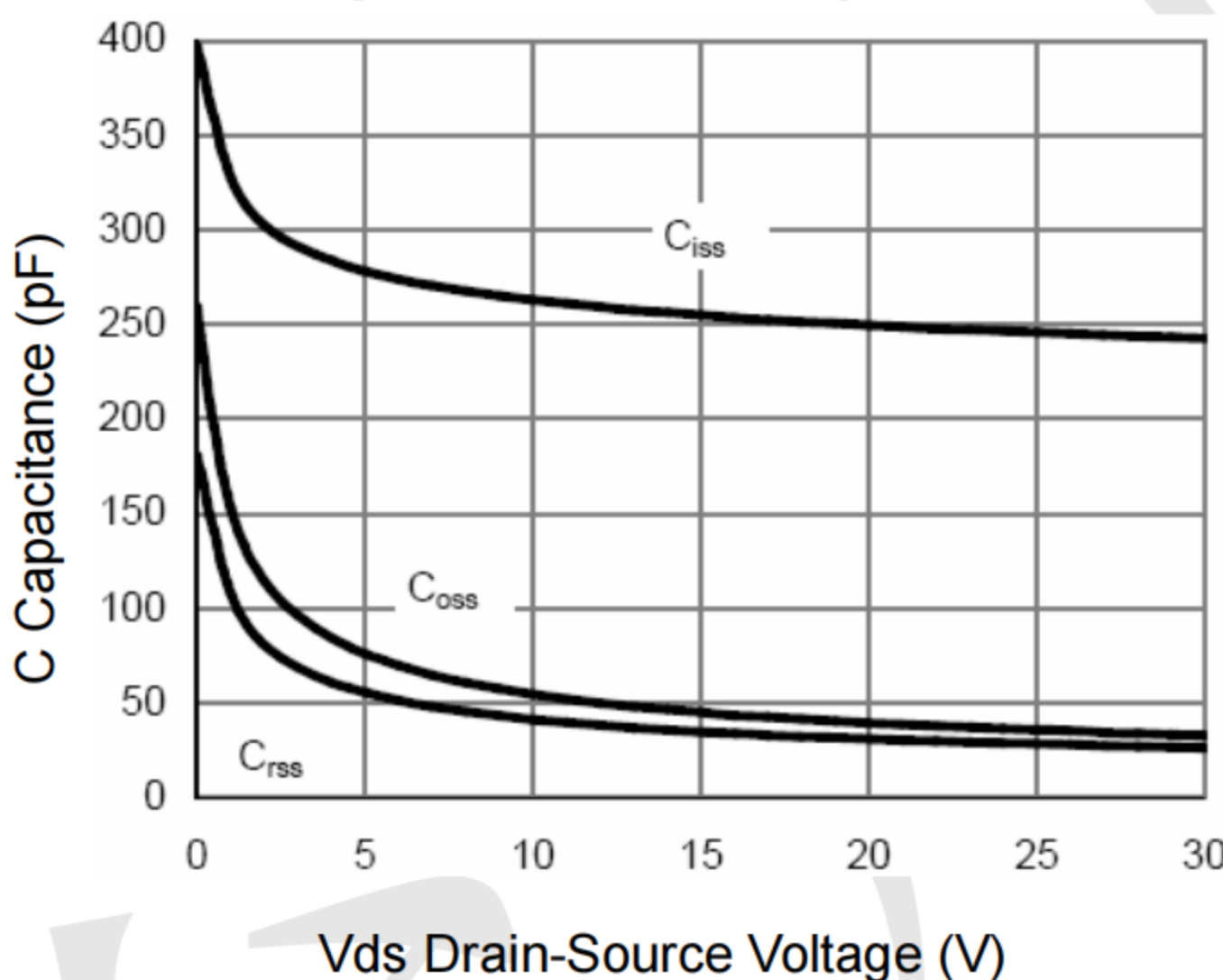

Figure 9 Capacitance vs Vds

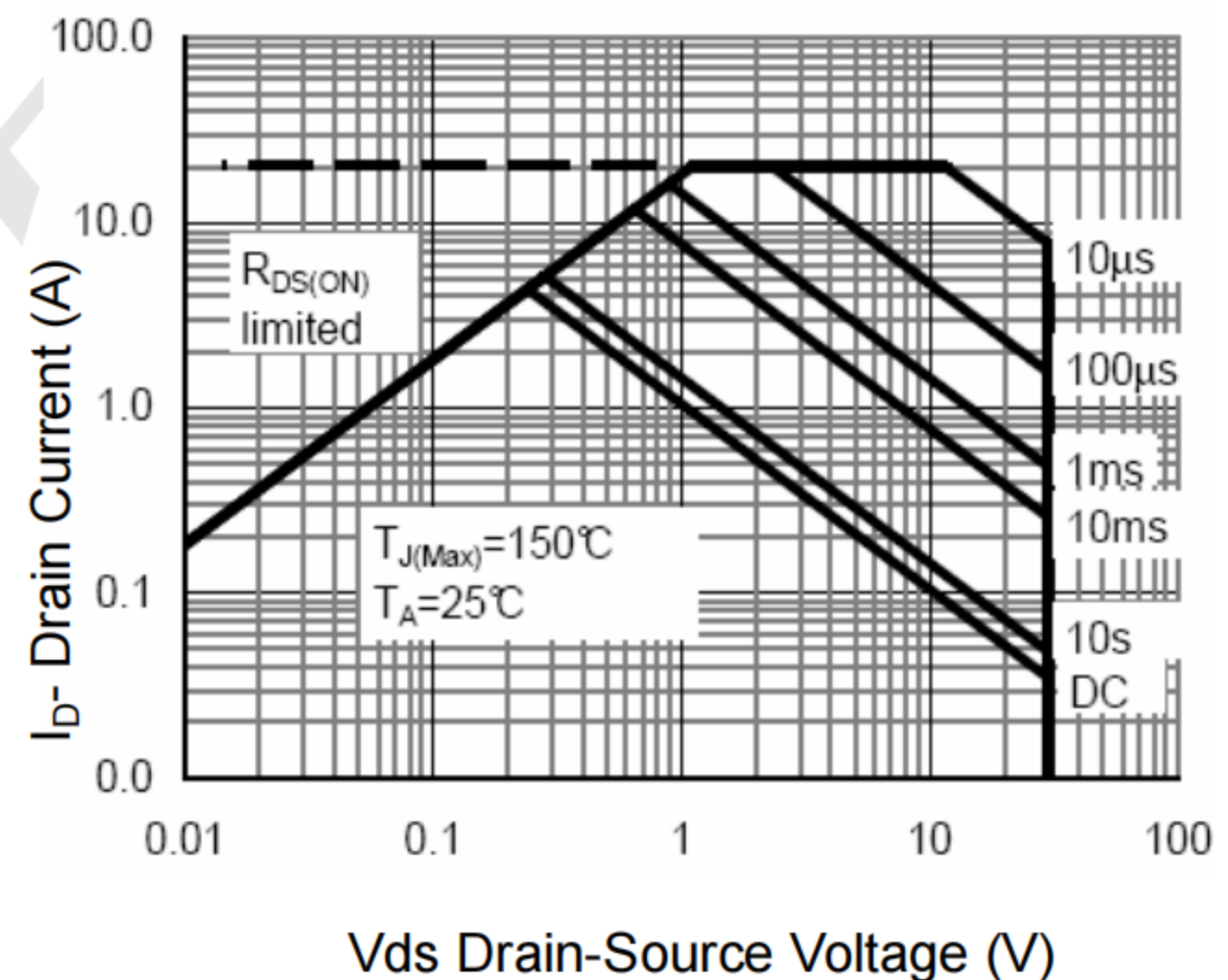

Figure 10 Safe Operation Area

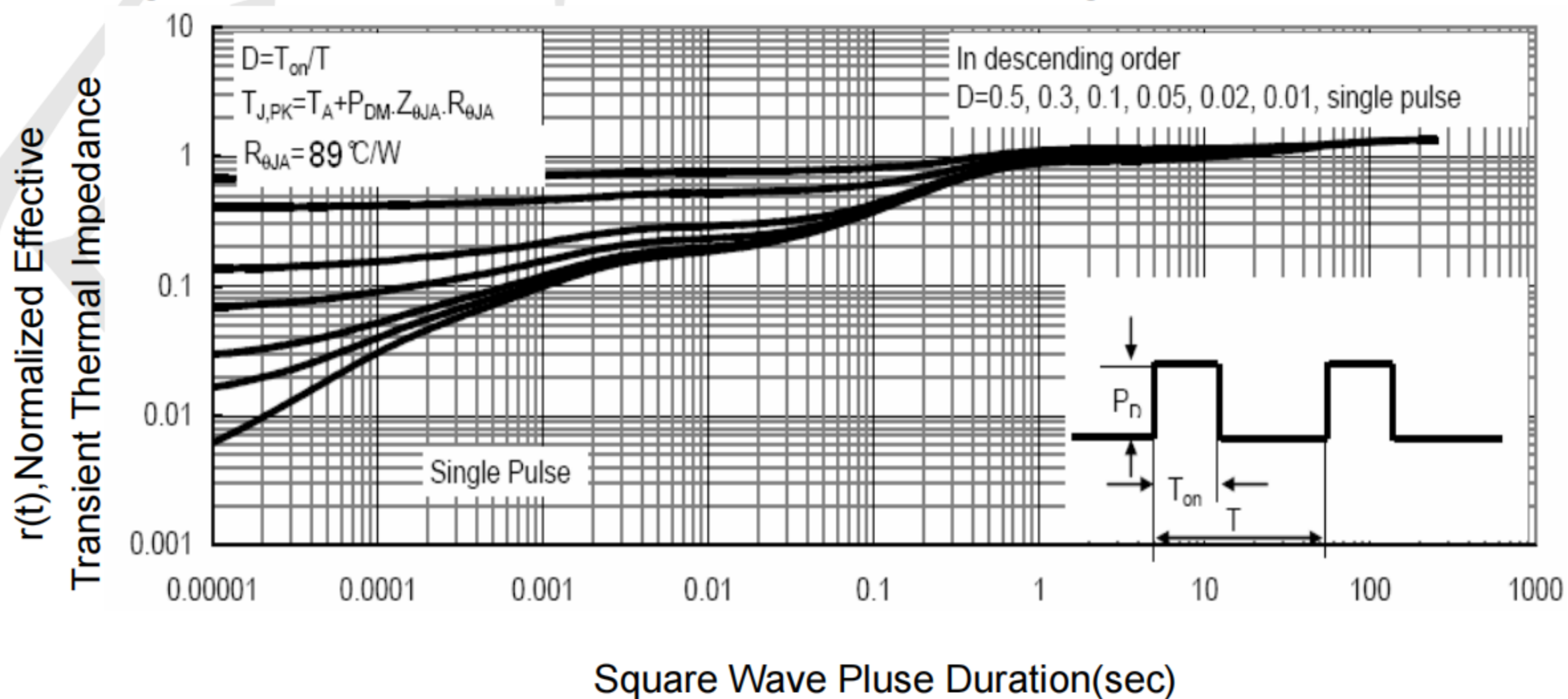
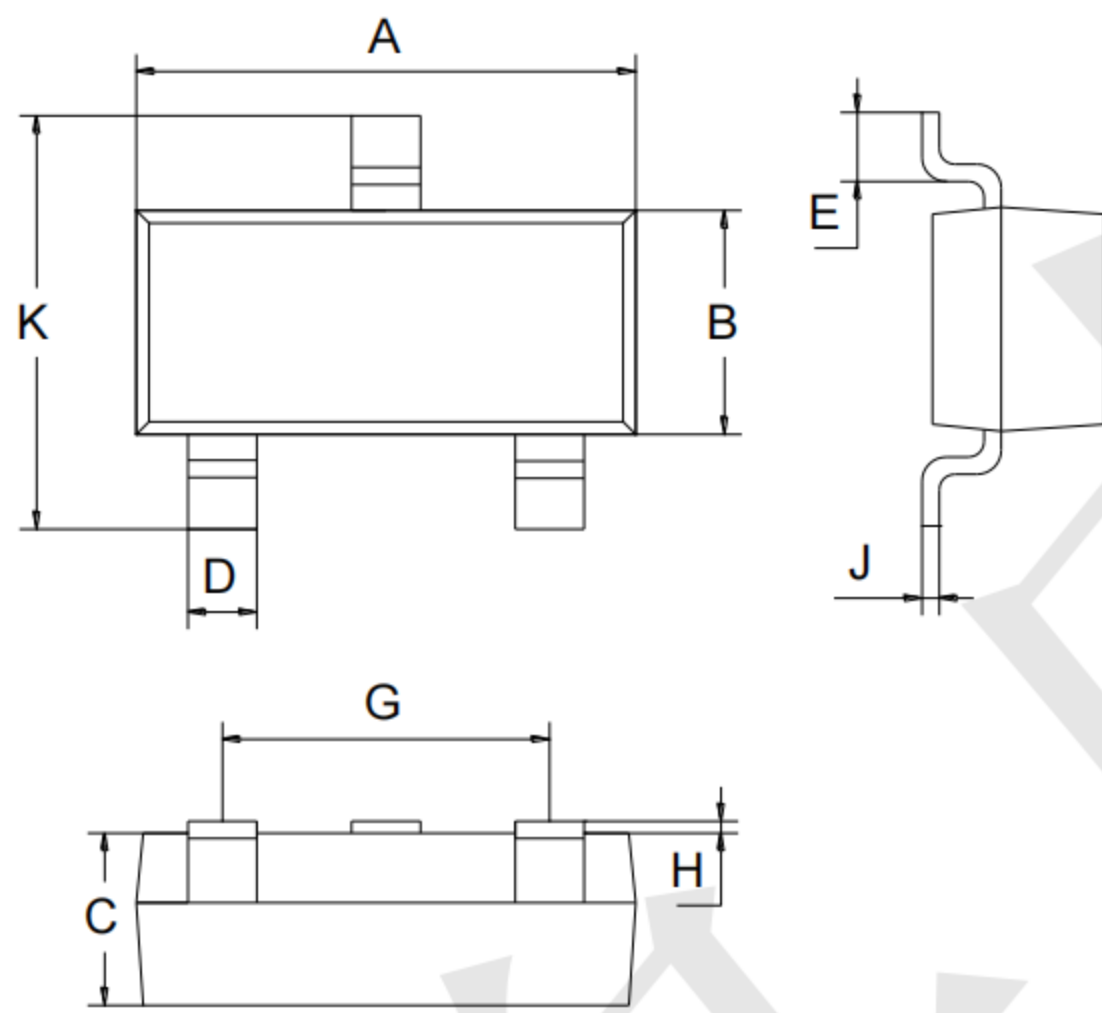

Figure 11 Normalized Maximum Transient Thermal Impedance



### Outline Drawing - SOT23



SOT-23		
Dimension	Min.	Max.
A	2.70	3.10
B	1.10	1.50
C	0.90	1.10
D	0.30	0.50
E	0.35	0.48
G	1.80	2.00
H	0.02	0.10
J	0.05	0.15
K	2.20	2.60

### Land Pattern - SOT23

