

## N-channel 650 V, 0.093 $\Omega$ typ., 32 A MDmesh™ DM2 Power MOSFET in a D<sup>2</sup>PAK package

Datasheet - preliminary data

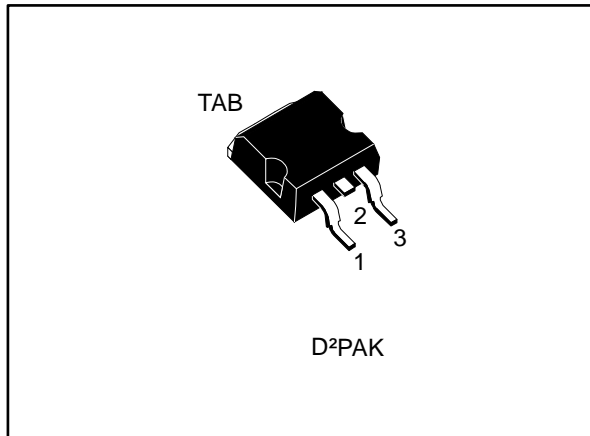
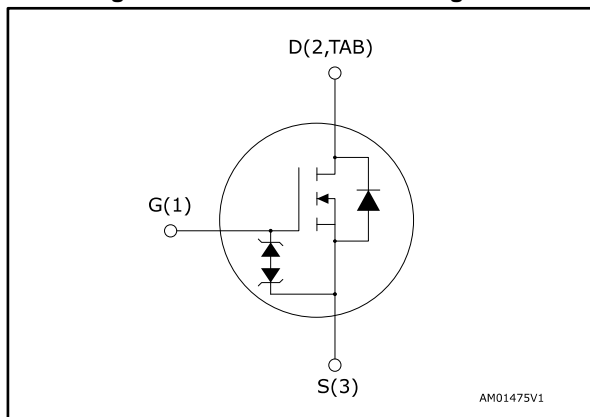

Figure 1: Internal schematic diagram



### Features

Order code	V <sub>DS</sub>	R <sub>DS(on)</sub> max.	I <sub>D</sub>	P <sub>TOT</sub>
STB35N65DM2	650 V	0.110 $\Omega$	32 A	250 W

- Fast-recovery body diode
- Extremely low gate charge and input capacitance
- Low on-resistance
- 100% avalanche tested
- Extremely high dv/dt ruggedness
- Zener-protected

### Applications

- Switching applications

### Description

This high voltage N-channel Power MOSFET is part of the MDmesh™ DM2 fast recovery diode series. It offers very low recovery charge ( $Q_{rr}$ ) and time ( $t_{rr}$ ) combined with low  $R_{DS(on)}$ , rendering it suitable for the most demanding high efficiency converters and ideal for bridge topologies and ZVS phase-shift converters.

Table 1: Device summary

Order code	Marking	Package	Packing
STB35N65DM2	35N65DM2	D <sup>2</sup> PAK	Tape and reel

---

**Contents**

<b>1</b>	<b>Electrical ratings .....</b>	<b>3</b>
<b>2</b>	<b>Electrical characteristics .....</b>	<b>4</b>
	2.1 Electrical characteristics (curves) .....	6
<b>3</b>	<b>Test circuits .....</b>	<b>8</b>
<b>4</b>	<b>Package information .....</b>	<b>9</b>
	4.1 D <sup>2</sup> PAK (TO-263) type A2 mechanical data .....	9
	4.2 D <sup>2</sup> PAK (TO-263) packing information.....	12
<b>5</b>	<b>Revision history .....</b>	<b>14</b>

# 1 Electrical ratings

**Table 2: Absolute maximum ratings**

Symbol	Parameter	Value	Unit
$V_{GS}$	Gate-source voltage	$\pm 25$	V
$I_D$	Drain current (continuous) at $T_{case} = 25\text{ }^\circ\text{C}$	32	A
	Drain current (continuous) at $T_{case} = 100\text{ }^\circ\text{C}$	20	
$I_{DM}^{(1)}$	Drain current (pulsed)	90	A
$P_{TOT}$	Total dissipation at $T_{case} = 25\text{ }^\circ\text{C}$	250	W
$dv/dt^{(2)}$	Peak diode recovery voltage slope	50	V/ns
$dv/dt^{(3)}$	MOSFET $dv/dt$ ruggedness	50	
$T_{stg}$	Storage temperature range	-55 to 150	$^\circ\text{C}$
$T_j$	Operating junction temperature range		

**Notes:**

(1) Pulse width is limited by safe operating area.

(2)  $I_{SD} \leq 32\text{ A}$ ,  $di/dt = 900\text{ A}/\mu\text{s}$ ,  $V_{DS\text{ peak}} < V_{(BR)DSS}$ ,  $V_{DD} = 80\% V_{(BR)DSS}$

(3)  $V_{DS} \leq 520\text{ V}$

**Table 3: Thermal data**

Symbol	Parameter	Value	Unit
$R_{thj-case}$	Thermal resistance junction-case	0.5	$^\circ\text{C}/\text{W}$
$R_{thj-pcb}$	Thermal resistance junction-pcb <sup>(1)</sup>	30	

**Notes:**

(1) When mounted on a 1-inch<sup>2</sup> FR-4, 2 Oz copper board.

**Table 4: Avalanche characteristics**

Symbol	Parameter	Value	Unit
$I_{AR}$	Avalanche current, repetitive or non-repetitive	4	A
$E_{AS}^{(1)}$	Single pulse avalanche energy	1150	mJ

**Notes:**

(1) Starting  $T_j = 25\text{ }^\circ\text{C}$ ,  $I_D = I_{AR}$ ,  $V_{DD} = 50\text{ V}$ .

## 2 Electrical characteristics

( $T_{\text{case}} = 25\text{ °C}$  unless otherwise specified)

**Table 5: Static**

Symbol	Parameter	Test conditions	Min.	Typ.	Max.	Unit
$V_{(\text{BR})\text{DSS}}$	Drain-source breakdown voltage	$V_{\text{GS}} = 0\text{ V}$ , $I_{\text{D}} = 1\text{ mA}$	650			V
$I_{\text{DSS}}$	Zero gate voltage drain current	$V_{\text{GS}} = 0\text{ V}$ , $V_{\text{DS}} = 650\text{ V}$			1	$\mu\text{A}$
		$V_{\text{GS}} = 0\text{ V}$ , $V_{\text{DS}} = 650\text{ V}$ , $T_{\text{case}} = 125\text{ °C}^{(1)}$			100	
$I_{\text{GSS}}$	Gate-body leakage current	$V_{\text{DS}} = 0\text{ V}$ , $V_{\text{GS}} = \pm 25\text{ V}$			$\pm 5$	$\mu\text{A}$
$V_{\text{GS(th)}}$	Gate threshold voltage	$V_{\text{DS}} = V_{\text{GS}}$ , $I_{\text{D}} = 250\text{ }\mu\text{A}$	3	4	5	V
$R_{\text{DS(on)}}$	Static drain-source on-resistance	$V_{\text{GS}} = 10\text{ V}$ , $I_{\text{D}} = 16\text{ A}$		0.093	0.110	$\Omega$

**Notes:**

<sup>(1)</sup>Defined by design, not subject to production test.

**Table 6: Dynamic**

Symbol	Parameter	Test conditions	Min.	Typ.	Max.	Unit
$C_{\text{iss}}$	Input capacitance	$V_{\text{DS}} = 100\text{ V}$ , $f = 1\text{ MHz}$ , $V_{\text{GS}} = 0\text{ V}$	-	2540	-	$\text{pF}$
$C_{\text{oss}}$	Output capacitance		-	115	-	
$C_{\text{riss}}$	Reverse transfer capacitance		-	2.5	-	
$C_{\text{oss eq.}}^{(1)}$	Equivalent output capacitance	$V_{\text{DS}} = 0\text{ to }520\text{ V}$ , $V_{\text{GS}} = 0\text{ V}$	-	204	-	$\text{pF}$
$R_{\text{G}}$	Intrinsic gate resistance	$f = 1\text{ MHz}$ , $I_{\text{D}} = 0\text{ A}$	-	4.2	-	$\Omega$
$Q_{\text{g}}$	Total gate charge	$V_{\text{DD}} = 520\text{ V}$ , $I_{\text{D}} = 32\text{ A}$ , $V_{\text{GS}} = 0\text{ to }10\text{ V}$ (see <a href="#">Figure 15: "Test circuit for gate charge behavior"</a> )	-	56.3	-	$\text{nC}$
$Q_{\text{gs}}$	Gate-source charge		-	12.7	-	
$Q_{\text{gd}}$	Gate-drain charge		-	27.6	-	

**Notes:**

<sup>(1)</sup> $C_{\text{oss eq.}}$  is defined as a constant equivalent capacitance giving the same charging time as  $C_{\text{oss}}$  when  $V_{\text{DS}}$  increases from 0 to 80%  $V_{\text{DSS}}$ .

**Table 7: Switching times**

Symbol	Parameter	Test conditions	Min.	Typ.	Max.	Unit
$t_{\text{d(on)}}$	Turn-on delay time	$V_{\text{DD}} = 325\text{ V}$ , $I_{\text{D}} = 16\text{ A}$ , $R_{\text{G}} = 4.7\text{ }\Omega$ , $V_{\text{GS}} = 10\text{ V}$ (see <a href="#">Figure 14: "Test circuit for resistive load switching times"</a> and <a href="#">Figure 19: "Switching time waveform"</a> )	-	23.4	-	$\text{ns}$
$t_{\text{r}}$	Rise time		-	23	-	
$t_{\text{d(off)}}$	Turn-off delay time		-	72	-	
$t_{\text{f}}$	Fall time		-	10.4	-	

Table 8: Source-drain diode

Symbol	Parameter	Test conditions	Min.	Typ.	Max.	Unit
$I_{SD}$	Source-drain current		-		32	A
$I_{SDM}^{(1)}$	Source-drain current (pulsed)		-		90	A
$V_{SD}^{(2)}$	Forward on voltage	$V_{GS} = 0 \text{ V}$ , $I_{SD} = 32 \text{ A}$	-		1.6	V
$t_{rr}$	Reverse recovery time	$I_{SD} = 32 \text{ A}$ , $di/dt = 100 \text{ A}/\mu\text{s}$ , $V_{DD} = 60 \text{ V}$ (see <a href="#">Figure 16: "Test circuit for inductive load switching and diode recovery times"</a> )	-	100		ns
$Q_{rr}$	Reverse recovery charge		-	0.42		$\mu\text{C}$
$I_{RRM}$	Reverse recovery current		-	8.4		A
$t_{rr}$	Reverse recovery time	$I_{SD} = 32 \text{ A}$ , $di/dt = 100 \text{ A}/\mu\text{s}$ , $V_{DD} = 60 \text{ V}$ , $T_j = 150 \text{ }^\circ\text{C}$ (see <a href="#">Figure 16: "Test circuit for inductive load switching and diode recovery times"</a> )	-	205		ns
$Q_{rr}$	Reverse recovery charge		-	1.8		$\mu\text{C}$
$I_{RRM}$	Reverse recovery current		-	17.6		A

**Notes:**

(1)Pulse width is limited by safe operating area.

(2)Pulse test: pulse duration = 300  $\mu\text{s}$ , duty cycle 1.5%

## 2.1 Electrical characteristics (curves)

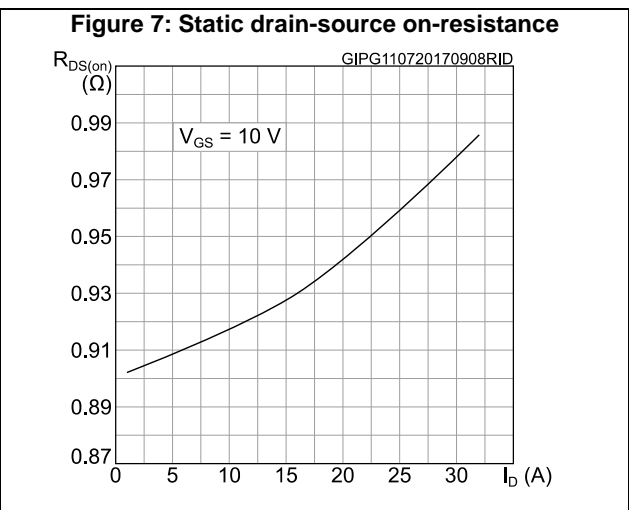
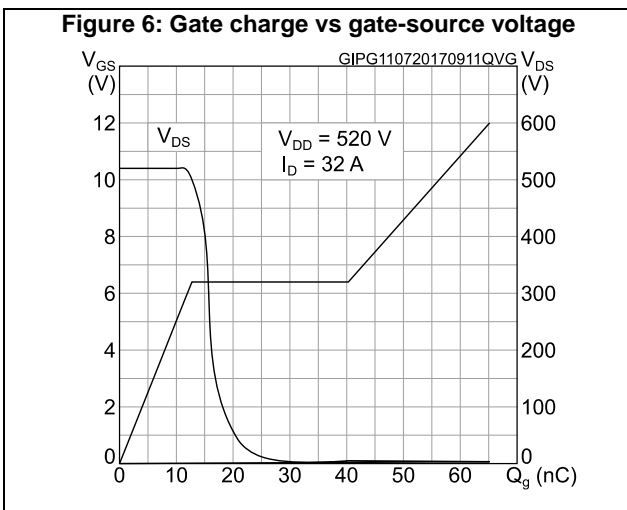
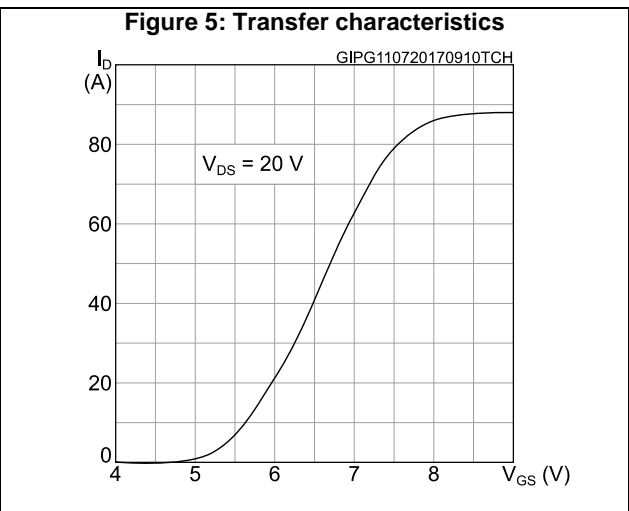
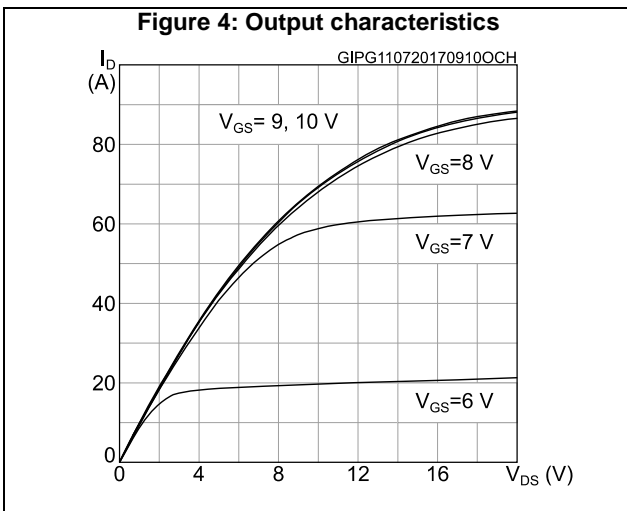
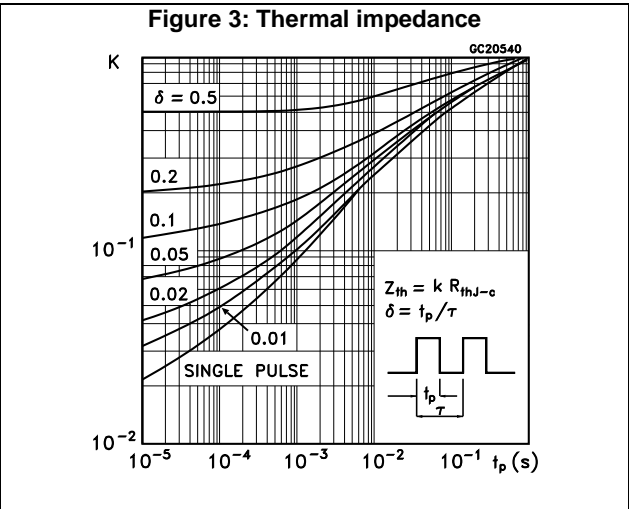
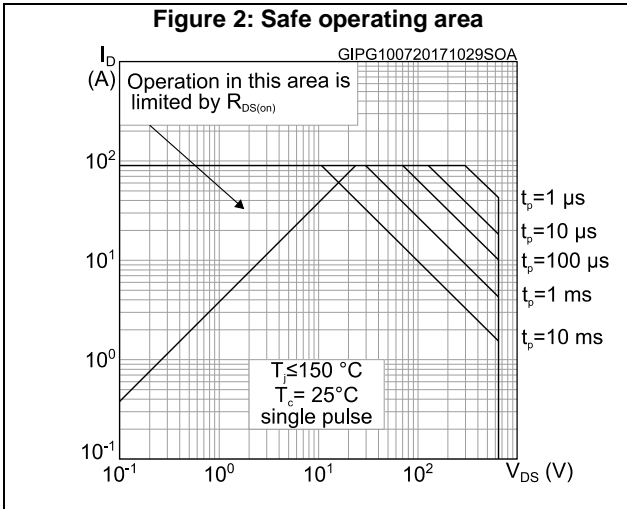

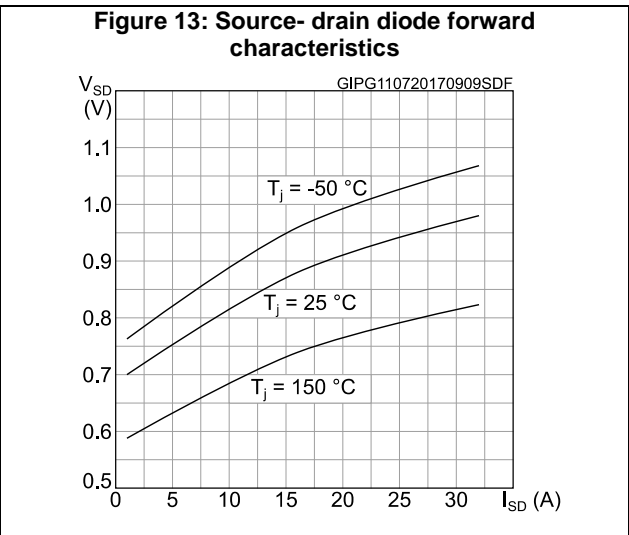
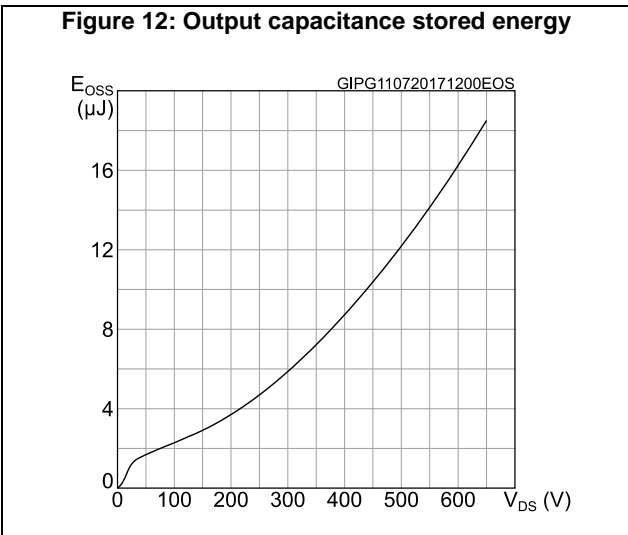
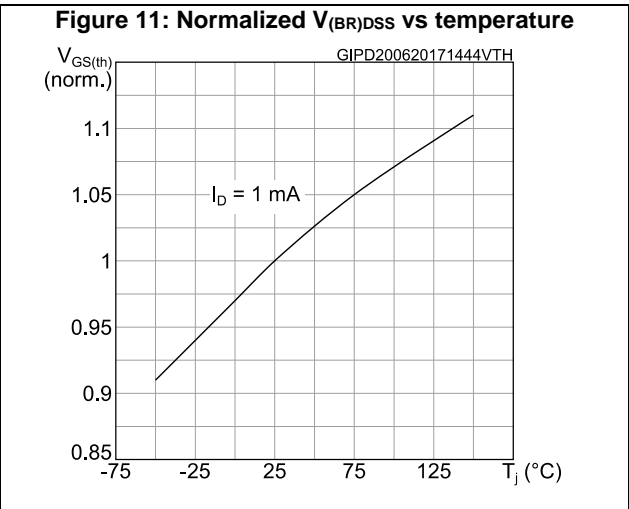
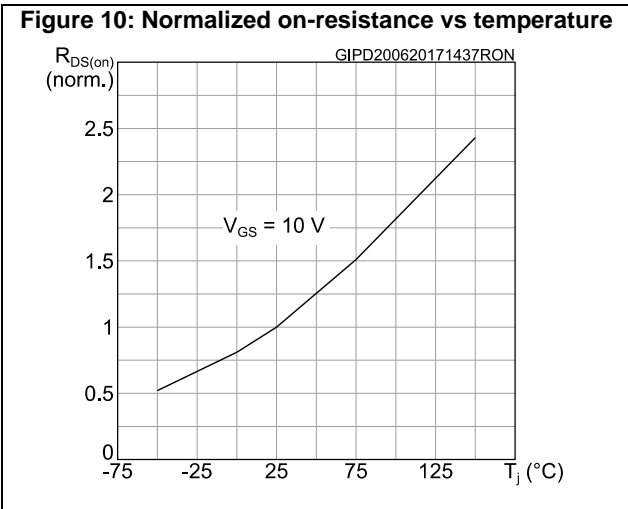
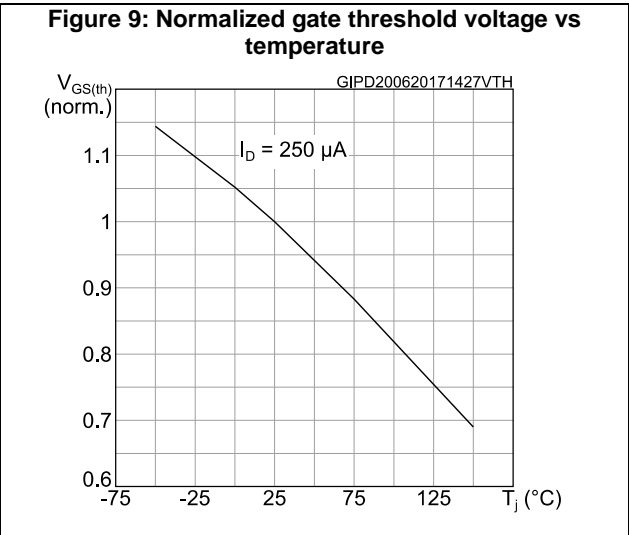
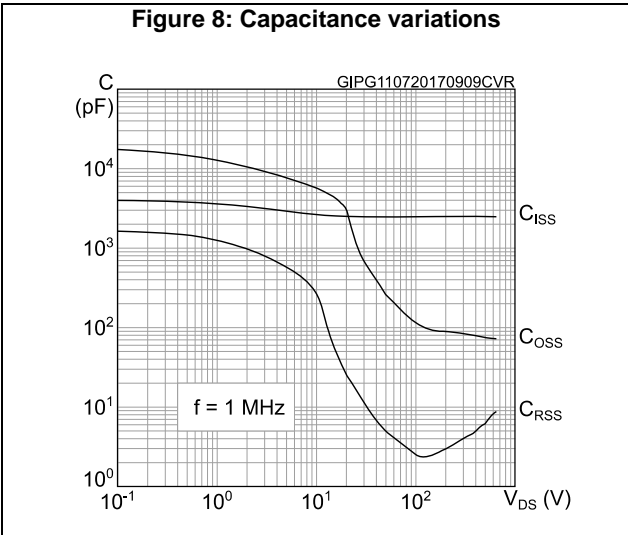

### 3 Test circuits

**Figure 14: Test circuit for resistive load switching times**



AM01468v1

**Figure 15: Test circuit for gate charge behavior**



AM01469v1

**Figure 16: Test circuit for inductive load switching and diode recovery times**



AM01470v1

**Figure 17: Unclamped inductive load test circuit**



AM01471v1

**Figure 18: Unclamped inductive waveform**

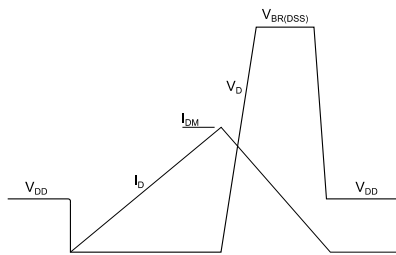

AM01472v1

**Figure 19: Switching time waveform**

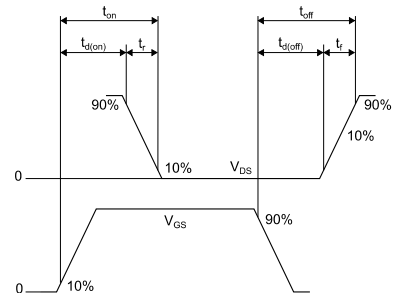

AM01473v1



## 4 Package information

In order to meet environmental requirements, ST offers these devices in different grades of ECOPACK® packages, depending on their level of environmental compliance. ECOPACK® specifications, grade definitions and product status are available at: [www.st.com](http://www.st.com). ECOPACK® is an ST trademark.

### 4.1 D<sup>2</sup>PAK (TO-263) type A2 mechanical data

Figure 20: D<sup>2</sup>PAK (TO-263) type A2 package outline

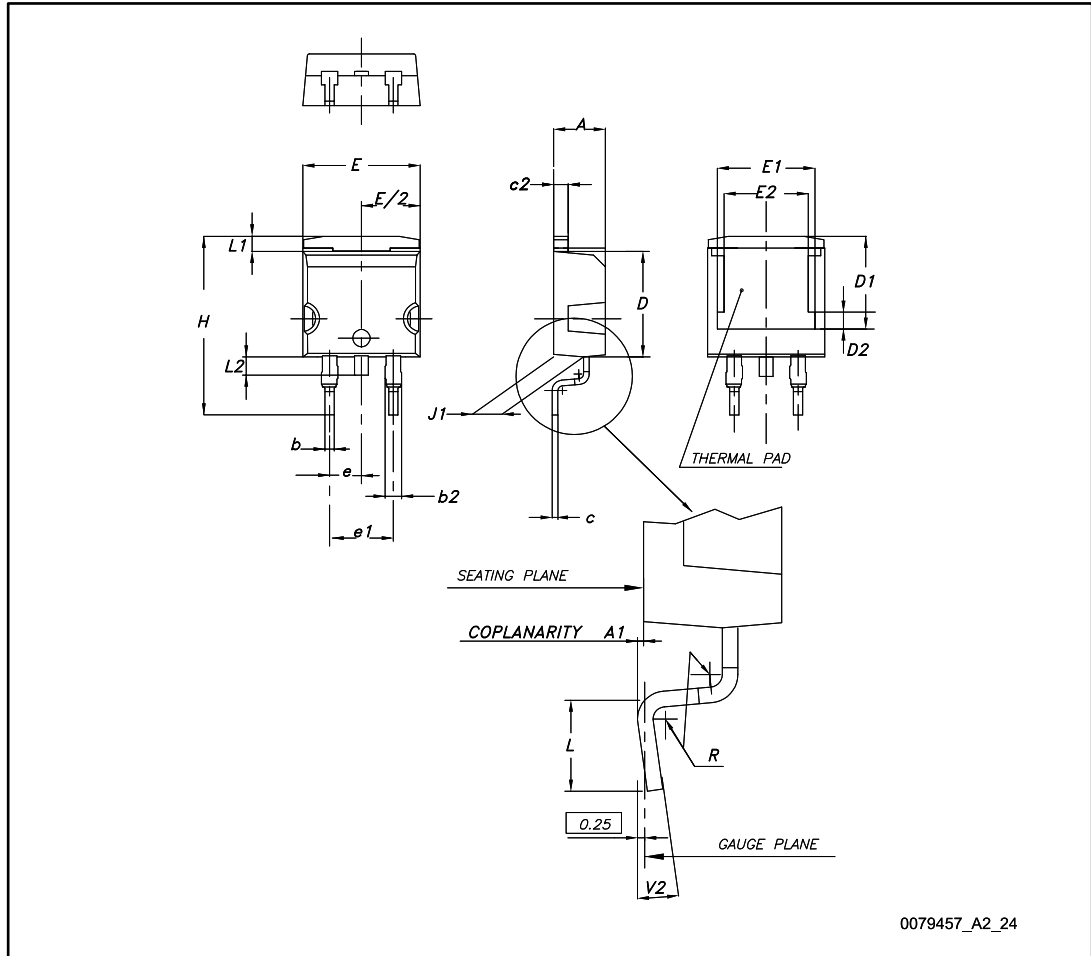
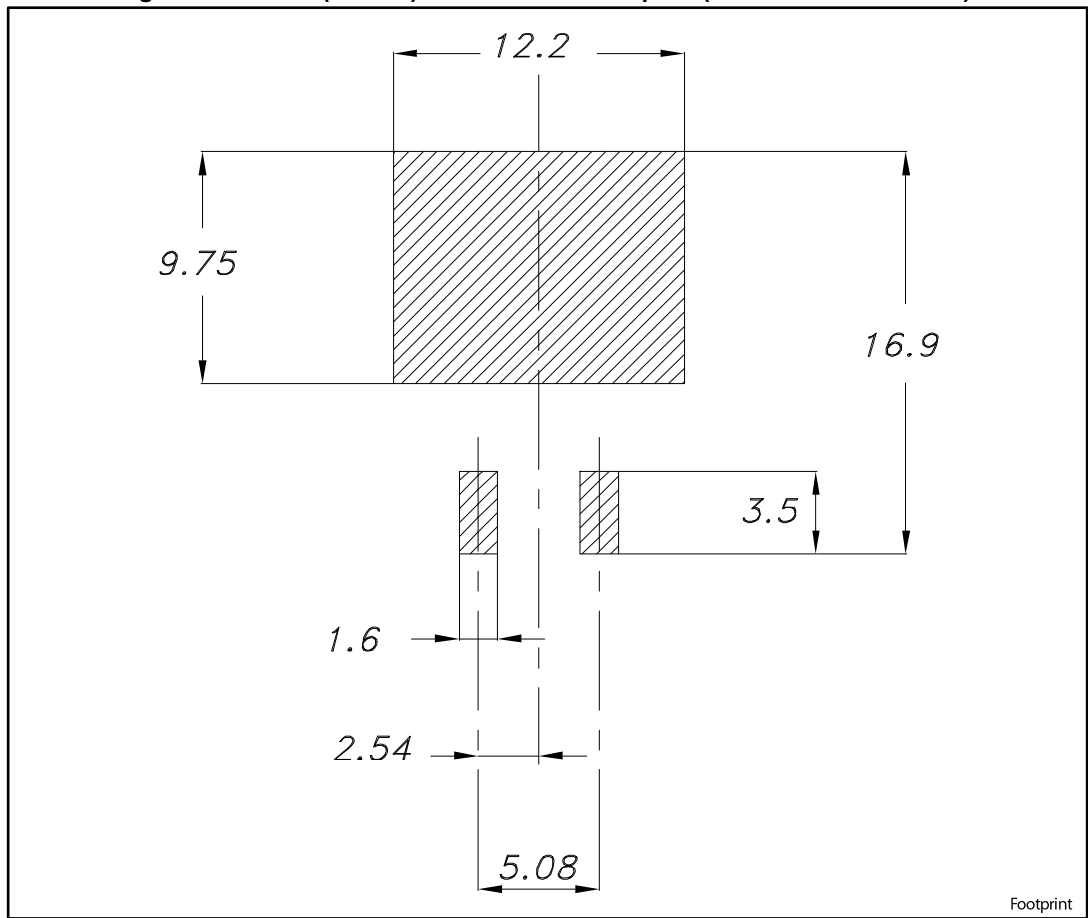

Table 9: D<sup>2</sup>PAK (TO-263) type A2 package mechanical data

Dim.	mm		
	Min.	Typ.	Max.
A	4.40		4.60
A1	0.03		0.23
b	0.70		0.93
b2	1.14		1.70
c	0.45		0.60
c2	1.23		1.36
D	8.95		9.35
D1	7.50	7.75	8.00
D2	1.10	1.30	1.50
E	10.00		10.40
E1	8.70	8.90	9.10
E2	7.30	7.50	7.70
e		2.54	
e1	4.88		5.28
H	15.00		15.85
J1	2.49		2.69
L	2.29		2.79
L1	1.27		1.40
L2	1.30		1.75
R		0.40	
V2	0°		8°

Figure 21: D<sup>2</sup>PAK (TO-263) recommended footprint (dimensions are in mm)



### 4.2 D<sup>2</sup>PAK (TO-263) packing information

Figure 22: D<sup>2</sup>PAK tape outline

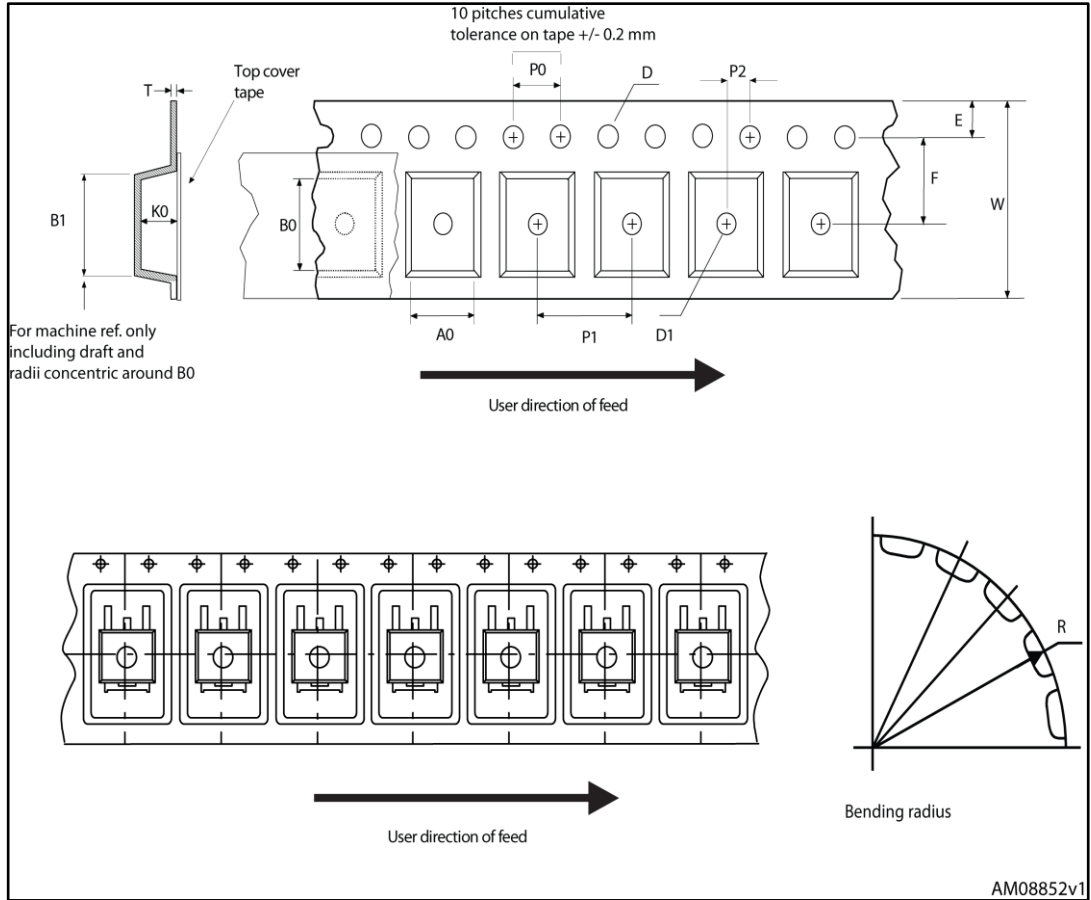
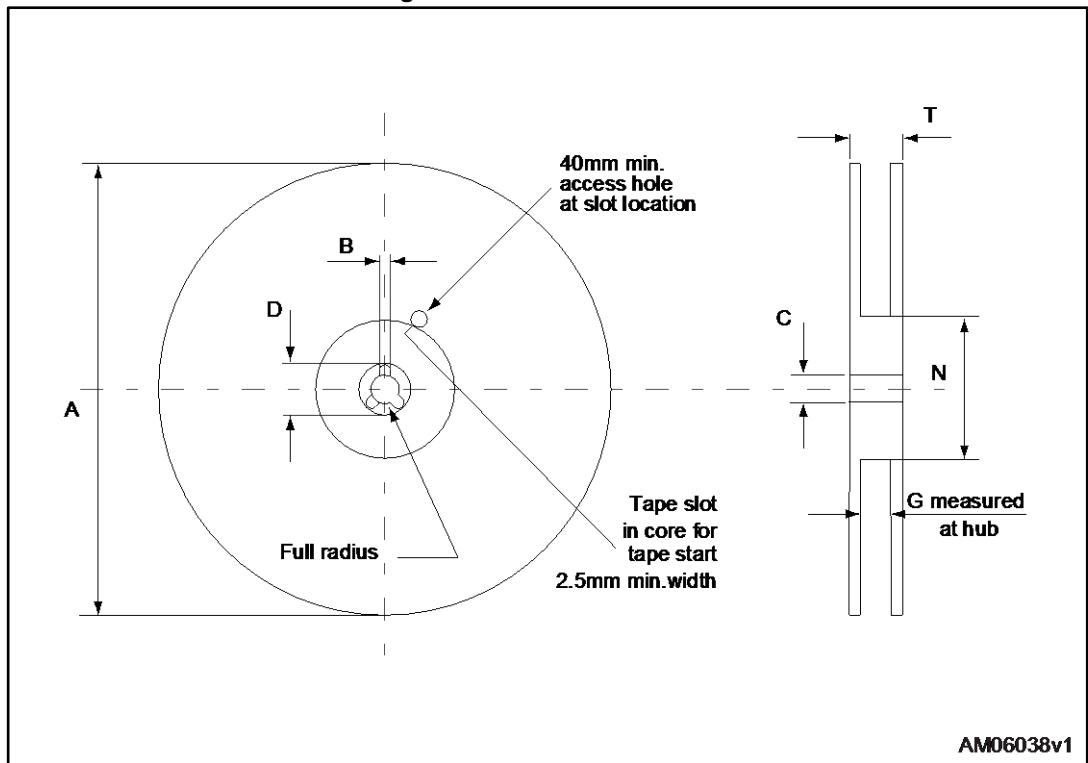

Figure 23: D<sup>2</sup>PAK reel outline



AM06038v1

Table 10: D<sup>2</sup>PAK tape and reel mechanical data

Tape			Reel		
Dim.	mm		Dim.	mm	
	Min.	Max.		Min.	Max.
A0	10.5	10.7	A		330
B0	15.7	15.9	B	1.5	
D	1.5	1.6	C	12.8	13.2
D1	1.59	1.61	D	20.2	
E	1.65	1.85	G	24.4	26.4
F	11.4	11.6	N	100	
K0	4.8	5.0	T		30.4
P0	3.9	4.1			
P1	11.9	12.1	Base quantity		1000
P2	1.9	2.1	Bulk quantity		1000
R	50				
T	0.25	0.35			
W	23.7	24.3			

## 5 Revision history

Table 11: Document revision history

Date	Revision	Changes
10-Jul-2017	1	Initial release
15-Jan-2018	2	Modified <i>Table 2: "Absolute maximum ratings"</i> , <i>Table 8: "Source-drain diode"</i> . Modified <i>Figure 2: "Safe operating area"</i> . Modified <i>Section 4: "Package information"</i> . Minor text changed.

**IMPORTANT NOTICE – PLEASE READ CAREFULLY**

STMicroelectronics NV and its subsidiaries ("ST") reserve the right to make changes, corrections, enhancements, modifications, and improvements to ST products and/or to this document at any time without notice. Purchasers should obtain the latest relevant information on ST products before placing orders. ST products are sold pursuant to ST's terms and conditions of sale in place at the time of order acknowledgement.

Purchasers are solely responsible for the choice, selection, and use of ST products and ST assumes no liability for application assistance or the design of Purchasers' products.

No license, express or implied, to any intellectual property right is granted by ST herein.

Resale of ST products with provisions different from the information set forth herein shall void any warranty granted by ST for such product.

ST and the ST logo are trademarks of ST. All other product or service names are the property of their respective owners.

Information in this document supersedes and replaces information previously supplied in any prior versions of this document.

© 2018 STMicroelectronics – All rights reserved