

规格书

Specification

品名
Model name

HYD-2310E

PROPRIETARY
Huayu Electronic co.,Ltd.

CONFIDENTIAL
Huayu Electronic co.,Ltd.

Version #	Spec V1.1
制作日期 Date	2022/03/01
准备 Prepared	Yi Shen Acoustic specialist,R&D Dept.
承认 Approved	Qian Wanjin Executive Manager,R&D Dept.



兴化市华宇电子有限公司

地址：江苏省兴化市陈堡工业区人民路 1 号

电话：13625199874 传真：0523-83723118

邮箱：391245375@qq.com 网址：www.js-huayu.com

*Components Operating Div.
Huayu Electronic co.,Ltd.*

1.适用范围：本规范适用于 HYD-2310E 蜂鸣器。

This specifications apply the HYD-2310E buzzer.

2.基本规格/General specification

项目/Item	规格/Spec	条件/Condition
1 额定电压 Rated voltage	12VDC	
2 工作电压 Operation voltage	3~24VDC	
3 声压 Sound Pressure Level=SPL	Min 85dB	测试环境：标准状态，标准驱动电路，额定电压 测试距离：0.1m Standard State,Standard Drive Circuit. Rated voltage,Distance at 0.1m
4 平均消费电流 Average consumption current	Max 10mA	
5 振荡频率 Oscillation frequency	3500±500Hz	
6 工作温度范围 Range of operation temperature	-20~+70°C	
7 保存温度范围 Range of preservation temperature	-30~+80°C	
8 外部尺寸 Externals size	Φ23*10	参阅附图 Refer to the attached drawing
9 重量 Mass	4g	

☆标准状态：常温（15~35℃），湿度（25~85%相对湿度），空气压力（860~1060hpa）

在假设的情况判断，测试是一基本状态下进行。

Standard State:Ordinary Temp(15~35°C),Humidity(25~85%RH),Air pressure(860~1060hPa)

In case of doubtful judgment,the test is re—performed under Basic State.

☆基本情况：温度。（20±2℃），湿度（60~70%相对湿度），空气压力（860~1060hpa）

Basic State: Temp.(20±2°C),Humidity(60~70%RH),Air pressure(860~1060hPa)

<标准驱动电路>/<Standard Drive Circuit>

<标标测试治具>/<Standard Test Fixture>

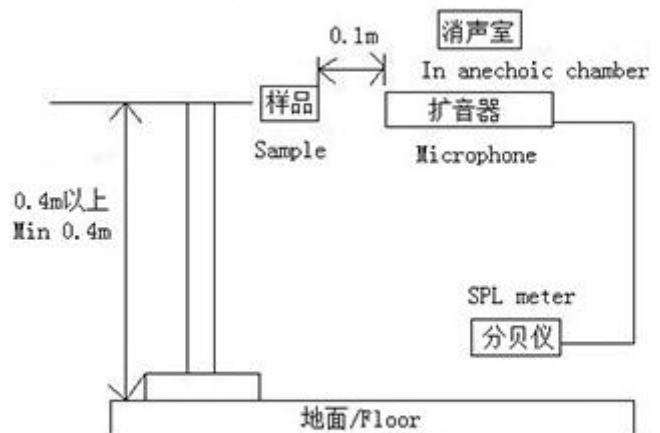
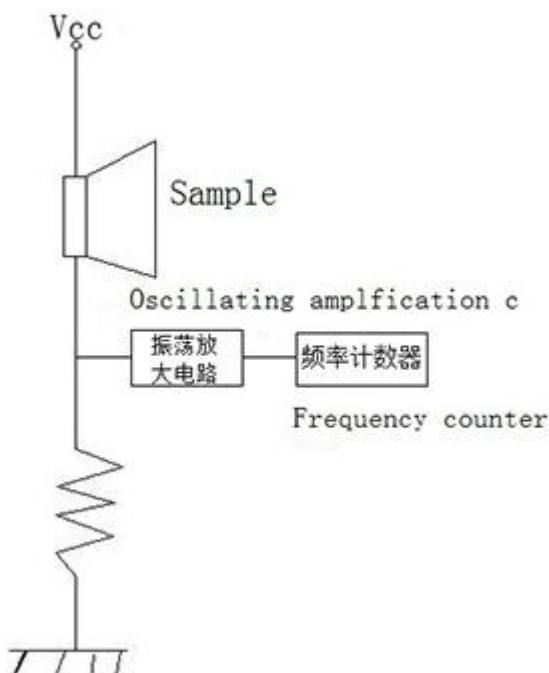

3.可靠性规范/Reliability specification

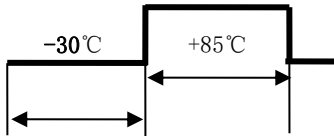
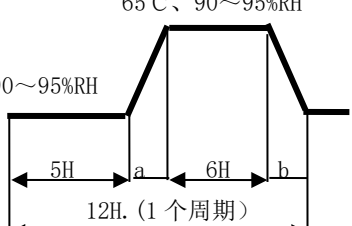
项目/Item	试验条件/Test condition	判断标准/Criteria	引用规格
高温保存试验 High temperature Preservation	+85℃环境下放置 96 小时 Exposure to +85℃ for 96 hrs.	经过测试, 符合规格, 没有任何不合格的外观和性能, 除了是 80 分贝或以上 (3500±500 Hz) After the test the part shall meet specifications without any degradation in appearance and performance except SPL. SPL shall be 80 dB More. (at 3500±500 Hz)	GB/T 2423.2
低温保存试验 Low temperature preservation	-30℃环境下放置 96 小时 Exposure to -30℃ for 96 hrs.		GB/T 2423.1
耐高温试验 Thermal Shock	 10 次周期 10 cycles		GB/T 2423.4
温湿度试验 Thermal, Humidity Shock	 a, b=0.5H		
常温寿命试验 Ordinary Temp. Life	常温 (25℃±10℃) 电压 12VDC 连续测试 1000 小时 Driving the sounder at 12VDC for 1000hrs in the room temperature (25℃±10℃)		
高温寿命试验 High Temp. Life	高温 (+80℃) 电压 12VDC 连续测试 500 小时 Driving the sounder at 12VDC for 500hrs in the low temperature (+80℃)		
低温寿命试验 Low Temp. Life	低温 (-20℃) 电压 12VDC 连续测试 500 小时 Driving the sounder at 12VDC for 500hrs in the low temperature (-20℃)		

4. 尺寸图/Dimension

(UNT: mm)

Tolerance: ±0.5mm Except Specified

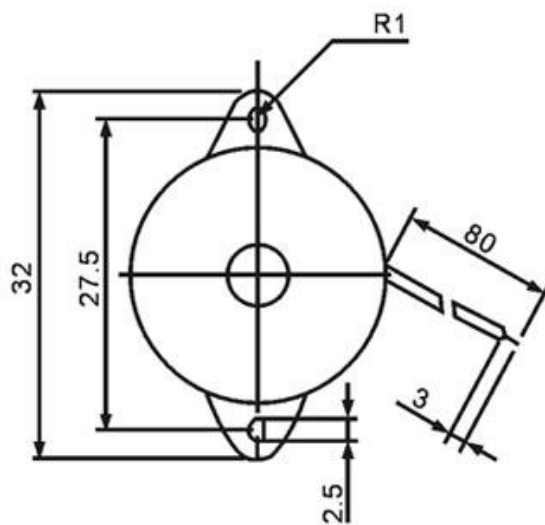
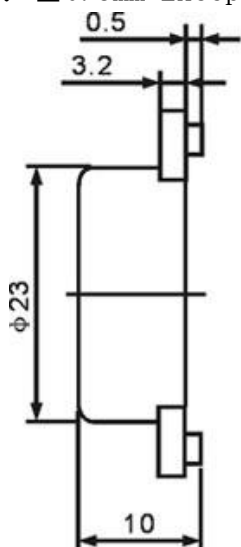

5. 频率图/Frequency Response:

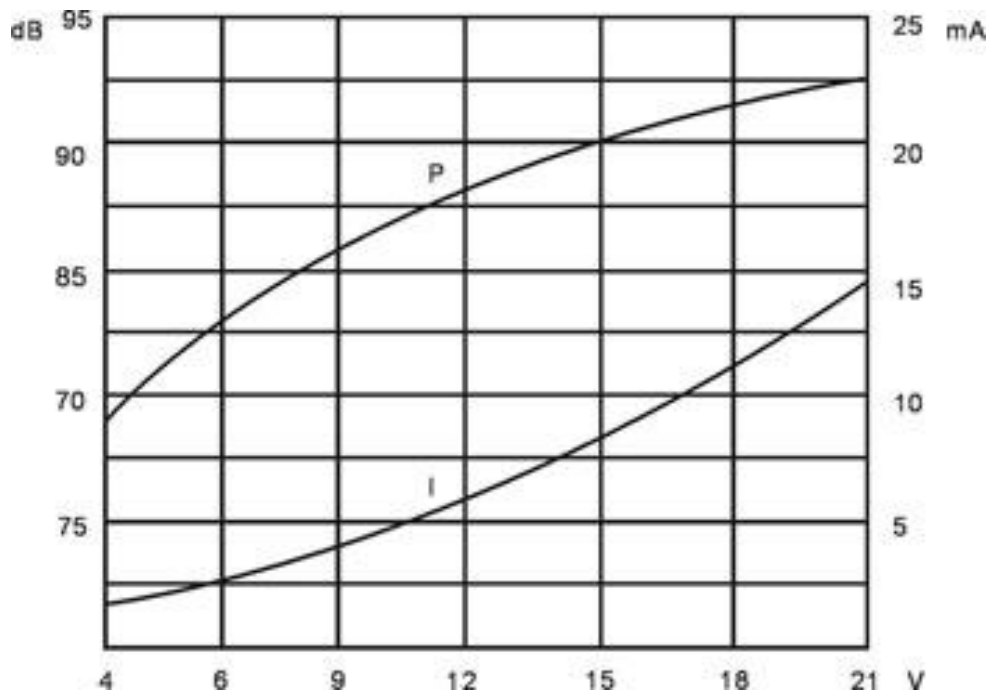

兴化市华宇电子有限公司

地址：江苏省兴化市陈堡工业区人民路 1 号

电话：13625199874 传真：0523-83723118

邮箱：391245375@qq.com 网址：www.js-huayu.com

*Components Operating Div.
Huayu Electronic co.,Ltd*