

# 规格书

## Specification

品名  
Model name **HYE1206-03ST**

**PROPRIETARY**  
Huayu Electronic co.,Ltd.

**CONFIDENTIAL**  
Huayu Electronic co.,Ltd.

Version #	Spec V1.0
制作日期 Date	2018/4/01
准备 Prepared	Yi Shen Acoustic specialist,R&D Dept.
承认 Approved	Qian Wanjin Executive Manager,R&D Dept.



## 兴化市华宇电子有限公司

地址：江苏省兴化市陈堡工业区人民路 1 号  
电话：13625199874 传真：0523-83723118  
邮箱：[391245375@qq.com](mailto:391245375@qq.com) 网址：[www.js-huayu.com](http://www.js-huayu.com)

*Components Operating Div.  
Huayu Electronic co.,Ltd.*

1.适用范围：本规范适用于 HYE1206-03ST 3V 蜂鸣器。

This specifications apply the HYE1206-03ST 3V buzzer.

2.基本规格/General specification

项目/Item		规格/Spec	条件/Condition
1	额定电压 Rated voltage	3.0V	
2	工作电压 Operation voltage	2~5V	
3	声压 Sound Pressure Level=SPL	Min 80dB	测试环境：标准状态，标准驱动电路，额定电压 测试距离：0.1m Standard State,Standard Drive Circuit. Rated voltage,Distance at 0.1m
4	电流 current	Max30mA	
5	振荡频率 Oscillation frequency	2600±400Hz	
6	工作温度范围 Operating Temperature	-20~+70°C	
7	保存温度范围 Storage temperature	-30~+80°C	
8	外部尺寸 Externals size (mm)	φ 12*H6.5	参阅附图 Refer to the attached drawing
9	重量 Mass	1.8g	
10	材质 Housing Material		

3. 电气和声学测试条件/Electrical And Acoustical Measuring Condition

驱动电路/Recommended Driving Circuit

Resonant frequency, 1/2 duty cycle. Square wave.  
Signal amplitude should be large enough to saturate the transistor.

设置 Recommended Setting

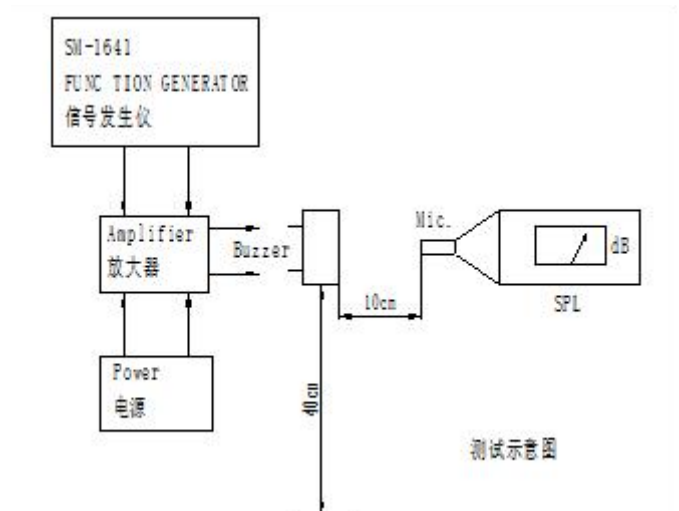
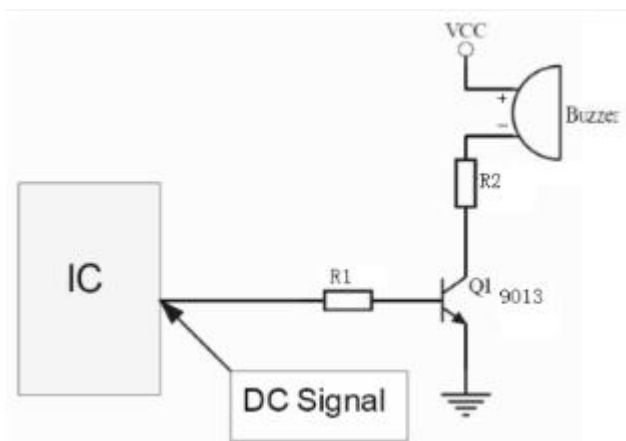

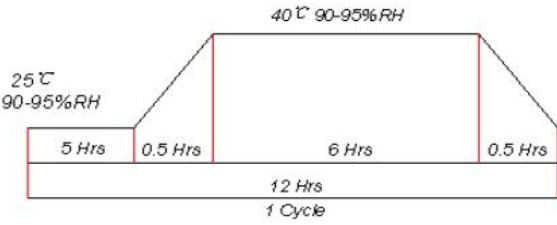
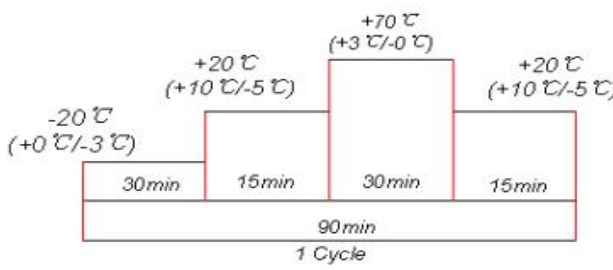
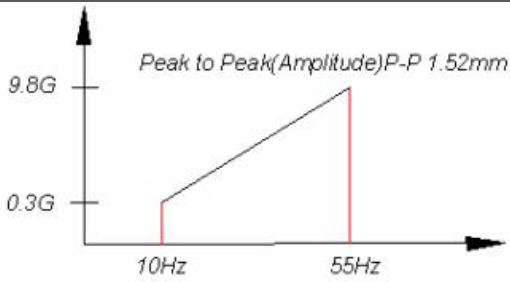
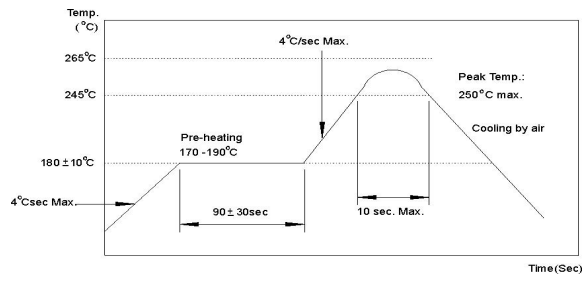
	项目 ITEM	测试方法 TEST
1	高温试验 High Temperature Test	在+80°C±2°C储存温度下存放 96 小时，恢复 2 小时后测试 After being placed in a chamber with +80±2°C for 96 hours and then being placed in normal condition for 2 hours
2	低温试验 Low Temperature Test	在-20°C±2°C储存温度下存放 96 小时，恢复 2 小时后测试 After being placed in a chamber with -20±2°C for 96 hours and then being placed in normal condition for 2 hours
3	恒定湿热试验 Humidity Test	
4	温度变化试验 Temperature Cycle Test	
5	振动试验 Vibration Test	
6	跌落试验 Drop Test	70cm 高自由掉落到 40mm 的木板上，每个方向三次 Drop on a hard wood board of 40mm thick, any directions, three times, at the height of 70cm
7	插针的抗拉强度试验 Terminal Strength Pulling Test	插针承受 1.0kg 拉力，负荷时间 5s The force 5 seconds of 1.0kg is applied to each terminal.
8	可焊性试验 Solder ability Test	焊锡温度 250±5°C，浸润时间为 3±0.5s，试验后目测产品情况 Lead terminals are immersed in rosin for 5 seconds and then immersed in solder bath of 250±5°C for 3±0.5 seconds.
9	回流焊测试 Soldering Test	

## 5. 尺寸图/Dimension

(UNT: mm)

Tolerance:  $\pm 0.5\text{mm}$  Except Specified

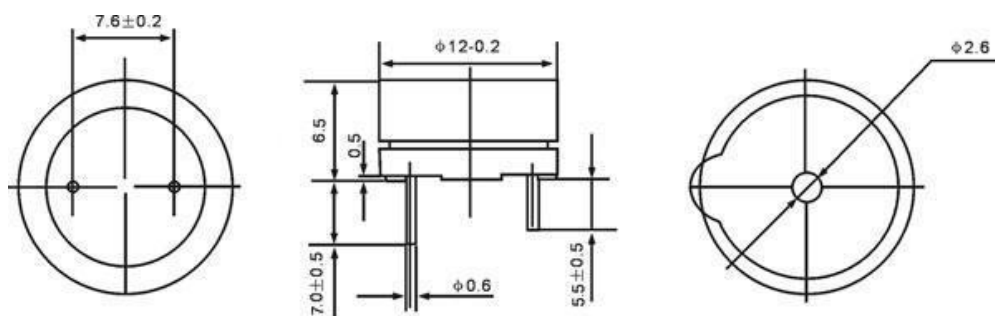

## 6. 频率图/Frequency Curve

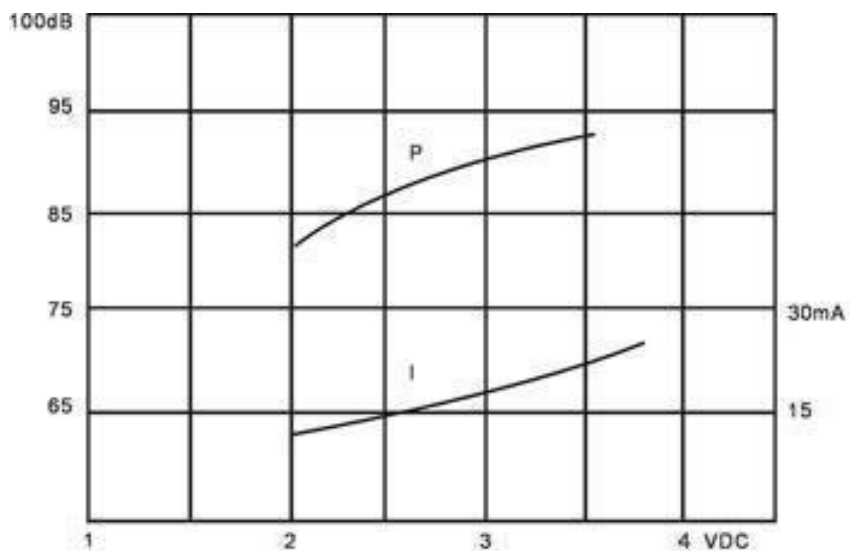

3V<sub>o-p</sub> 50% duty Square wave, 10cm

## 7. Packing Method/包装图

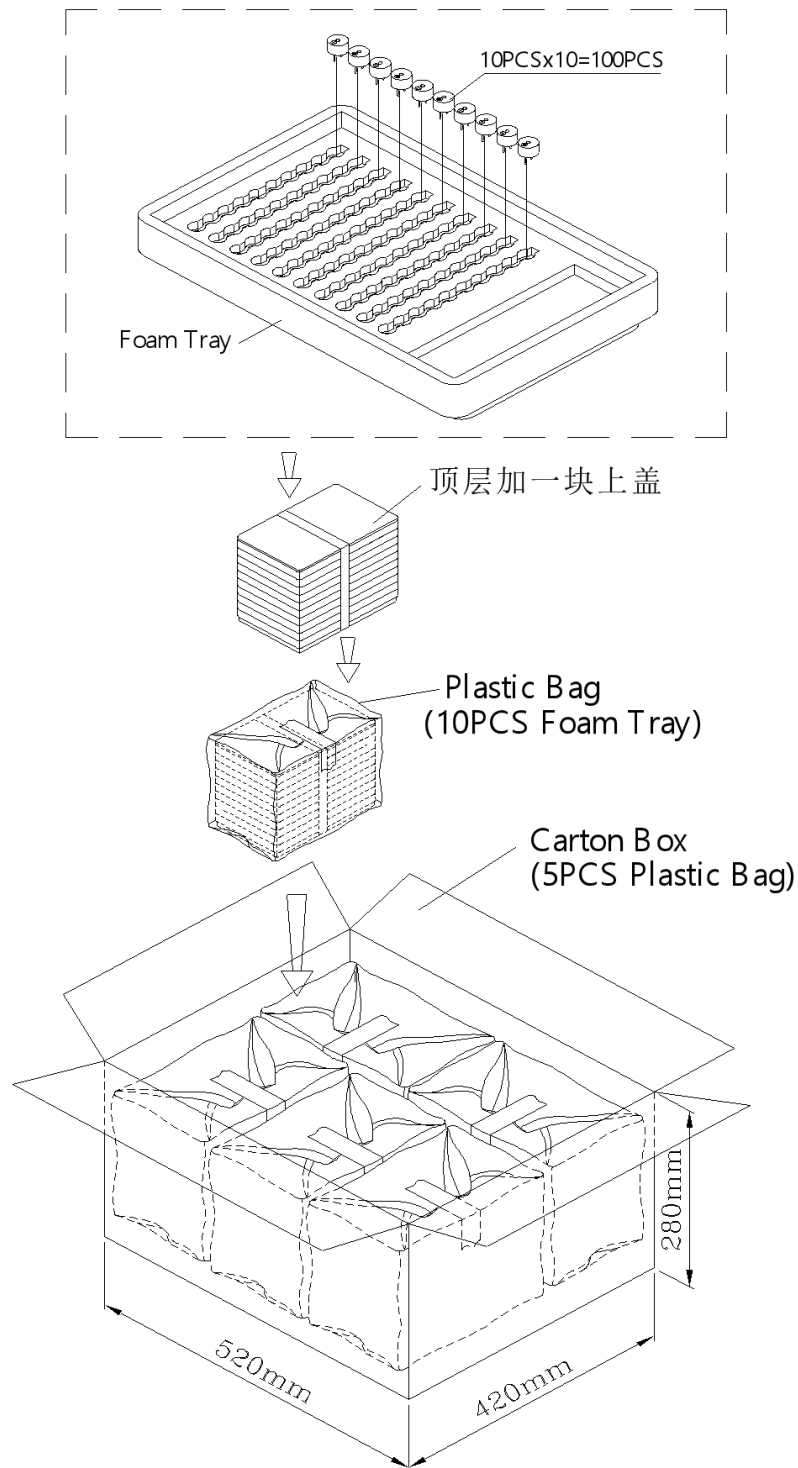

Foam Tray	240mmx160mmx30mm	1x100PCS=100PCS
Plastic Bag		10x100PCS=1000PCS
Carton Box	520mmx420mmx280mm	5x1000PCS=5,000PCS



兴化市华宇电子有限公司

Components Operating Div.  
Huayu Electronic co.,Ltd.