

## SMD ■ B

## 18-239A/R6GHBHC-M01/2T(DF)

**Features**

- Package in 8mm tape on 7" diameter reel.
- Compatible with automatic placement equipment.
- Compatible with infrared and vapor phase reflow solder process.
- Multi-color type.
- Pb-free.
- The product itself will remain within RoHS compliant version.
- Compliance with EU REACH.
- Compliance Halogen Free .(Br <900 ppm ,Cl <900 ppm , Br+Cl < 1500 ppm).

**Description**

- The 18-239A SMD LED is much smaller than lead frame type components, thus enable smaller board size, higher packing density, reduced storage space and finally smaller equipment to be obtained.
- Besides, lightweight makes them ideal for miniature applications. etc.

**Applications**

- Backlighting in dashboard and switch.
- Telecommunication: indicator and backlighting in telephone and fax.
- Flat backlight for LCD, switch and symbol.
- General use.

### Device Selection Guide

Code	Chip Materials	Emitted Color	Resin Color
R6	AlGaInP	Brilliant Red	Water Clear
GH	InGaN	Brilliant Green	
BH	InGaN	Blue	

### Absolute Maximum Ratings (Ta=25°C)

Parameter	Symbol	Code	Rating	Unit
Reverse Voltage	$V_R$		5	V
Forward Current	$I_F$	R6	30	mA
		GH	25	
		BH	10	
Peak Forward Current (Duty 1/10 @1KHz)	$I_{FP}$	R6	60	mA
		GH	100	
		BH	20	
Power Dissipation	$P_d$	R6	60	mW
		GH	95	
		BH	30	
Electrostatic Discharge(HBM)	ESD	R6	2000	V
		GH	1000	
		BH	1000	
Operating Temperature	$T_{opr}$		-40 ~ +85	°C
Storage Temperature	$T_{stg}$		-40 ~ +90	°C
Soldering Temperature	$T_{sol}$		Reflow Soldering : 260 °C for 10 sec. Hand Soldering : 350 °C for 3 sec.	

**Electro-Optical Characteristics (Ta=25°C)**

Parameter	Symbol	Code	Min.	Typ.	Max.	Unit	Condition
*Luminous Intensity	I <sub>v</sub>	R6	25.0	-----	45.0	mcd	
		GH	35.0	-----	65.0		
		BH	16.0	-----	24.0		
*Dominant Wavelength	λ <sub>d</sub>	R6	622	-----	632	nm	I <sub>F</sub> =2mA
		GH	524	-----	538		
		BH	465	-----	475		
*Forward Voltage	V <sub>F</sub>	R6	1.75	-----	2.15	V	
		GH	2.65	-----	2.95		
		BH	2.60	-----	2.85		

\*Just for reference.

Parameter	Symbol	Code	Min.	Typ.	Max.	Unit	Condition
**Luminous Intensity	I <sub>v</sub>		45	-----	90	mcd	
Viewing Angle	2θ <sub>1/2</sub>		-----	120	-----	Deg	
Peak Wavelength	λ <sub>p</sub>	R6	-----	632	-----	nm	
		GH	-----	518	-----		
		BH	-----	465	-----		
Dominant Wavelength	λ <sub>d</sub>	R6	-----	624	-----	nm	R6 : I <sub>F</sub> =0.9 mA GH : I <sub>F</sub> =2 mA BH : I <sub>F</sub> =0.65 mA
		GH	-----	525	-----		
		BH	-----	470	-----		
Spectrum Radiation Bandwidth	Δλ	R6	-----	20	-----	nm	
		GH	-----	35	-----		
		BH	-----	25	-----		
Forward Voltage	V <sub>F</sub>	R6	1.70	-----	2.10	V	
		GH	2.65	-----	2.95		
		BH	2.55	-----	2.80		
Reverse Current	I <sub>R</sub>	R6			10	μA	V <sub>R</sub> =5V
		GH			50		
		BH	-----	-----	50		

\*\*When three LED dies are operated simultaneously.

- Note: 1. Tolerance of Luminous Intensity: ±11%  
 2. Tolerance of Dominant Wavelength: ±1nm  
 3. Tolerance of Forward Voltage: ±0.1V  
 4. RA test @ 2mA

### Bin Range of Luminous Intensity

Bin Code	Min.	Max.	Unit	Condition
P1-1	45.0	50.5	mcd	R6 : IF=0.9 mA GH : IF=2 mA BH : IF=0.65 mA
P1-2	50.5	57.0		
P2-1	57.0	64.0		
P2-2	64.0	72.0		
Q1-1	72.0	81.0		
Q1-2	81.0	90.0		

### Bin Range of Forward Voltage R6

Bin Code	Min.	Max.	Unit	Condition
1	1.70	1.90	V	IF=0.9mA
2	1.90	2.10		

### GH

Bin Code	Min.	Max.	Unit	Condition
0A	2.65	2.70	V	IF=2mA
0B	2.70	2.75		
1A	2.75	2.80		
1B	2.80	2.85		
2A	2.85	2.90		
2B	2.90	2.95		

### BH

Bin Code	Min.	Max.	Unit	Condition
1	2.55	2.65	V	IF=0.65mA
2	2.65	2.75		
3	2.75	2.80		

Note:

1. Tolerance of Luminous Intensity  $\pm 11\%$
2. Tolerance of Forward Voltage  $\pm 0.05V$

Chromaticity Coordinates Specifications for Bin Grading

Bin Code	CIE_x	CIE_y	Condition
BA	0.2570	0.2700	R6 : IF=0.9 mA GH : IF=2 mA BH : IF=0.65 mA
	0.2570	0.2825	
	0.2695	0.2875	
	0.2695	0.2750	
BB	0.2695	0.2750	
	0.2695	0.2875	
	0.2820	0.2925	
	0.2820	0.2800	
BC	0.282	0.2800	
	0.2820	0.2925	
	0.2945	0.2975	
	0.2945	0.2850	
BD	0.2945	0.2850	
	0.2945	0.2975	
	0.3070	0.3025	
	0.3070	0.2900	
BE	0.2570	0.2825	
	0.2570	0.2950	
	0.2695	0.3000	
	0.2695	0.2875	
BF	0.2695	0.2875	
	0.2695	0.3000	
	0.2820	0.3050	
	0.2820	0.2925	
BG	0.282	0.2925	
	0.2820	0.3050	
	0.2945	0.3100	
	0.2945	0.2975	
BH	0.2945	0.2975	
	0.2945	0.3100	
	0.3070	0.3150	
	0.3070	0.3025	

Bin Code	CIE_x	CIE_y	Condition
BJ	0.2570	0.2950	R6 : IF=0.9 mA GH : IF=2 mA BH : IF=0.65 mA
	0.2570	0.3075	
	0.2695	0.3125	
	0.2695	0.3000	
BK	0.2695	0.3000	
	0.2695	0.3125	
	0.2820	0.3175	
	0.2820	0.3050	
BL	0.282	0.3050	
	0.2820	0.3175	
	0.2945	0.3225	
	0.2945	0.3100	
BM	0.2945	0.3100	
	0.2945	0.3225	
	0.3070	0.3275	
	0.3070	0.3150	
BN	0.2570	0.3075	
	0.2570	0.3200	
	0.2695	0.3250	
	0.2695	0.3125	
BP	0.2695	0.3125	
	0.2695	0.3250	
	0.2820	0.3300	
	0.2820	0.3175	
BQ	0.282	0.3175	
	0.2820	0.3300	
	0.2945	0.3350	
	0.2945	0.3225	
BR	0.2945	0.3225	
	0.2945	0.3350	
	0.3070	0.3400	
	0.3070	0.3275	

Bin Code	CIE_x	CIE_y	Condition
DA	0.2570	0.3200	R6 : IF=0.9 mA GH : IF=2 mA BH : IF=0.65 mA
	0.2570	0.3325	
	0.2695	0.3375	
	0.2695	0.3250	
DB	0.2695	0.3250	
	0.2695	0.3375	
	0.2820	0.3425	
	0.2820	0.3300	
DC	0.282	0.3300	
	0.2820	0.3425	
	0.2945	0.3475	
	0.2945	0.3350	
DD	0.2945	0.3350	
	0.2945	0.3475	
	0.3070	0.3525	
	0.3070	0.3400	
DE	0.2570	0.3325	
	0.2570	0.3450	
	0.2695	0.3500	
	0.2695	0.3375	
DF	0.2695	0.3375	
	0.2695	0.3500	
	0.2820	0.3550	
	0.2820	0.3425	
DG	0.2820	0.3425	
	0.2820	0.3550	
	0.2945	0.3600	
	0.2945	0.3475	
DH	0.2945	0.3475	
	0.2945	0.3600	
	0.3070	0.3650	
	0.3070	0.3525	

Bin Code	CIE_x	CIE_y	Condition
DJ	0.2570	0.3450	R6 : IF=0.9 mA GH : IF=2 mA BH : IF=0.65 mA
	0.2570	0.3575	
	0.2695	0.3625	
	0.2695	0.3500	
DK	0.2695	0.3500	
	0.2695	0.3625	
	0.2820	0.3675	
	0.2820	0.3550	
DL	0.282	0.3550	
	0.2820	0.3675	
	0.2945	0.3725	
	0.2945	0.3600	
DM	0.2945	0.3600	
	0.2945	0.3725	
	0.3070	0.3775	
	0.3070	0.3650	
DN	0.2570	0.3575	
	0.2570	0.3700	
	0.2695	0.3750	
	0.2695	0.3625	
DP	0.2695	0.3625	
	0.2695	0.3750	
	0.2820	0.3800	
	0.2820	0.3675	
DQ	0.282	0.3675	
	0.2820	0.3800	
	0.2945	0.3850	
	0.2945	0.3725	
DR	0.2945	0.3725	
	0.2945	0.3850	
	0.3070	0.3900	
	0.3070	0.3775	

Notes:

- 1.The C.I.E. 1931 chromaticity diagram ( Tolerance  $\pm 0.01$  ).
- 2.The products are sensitive to static electricity and care must be fully taken when handling products.



CIE Chromaticity Diagram

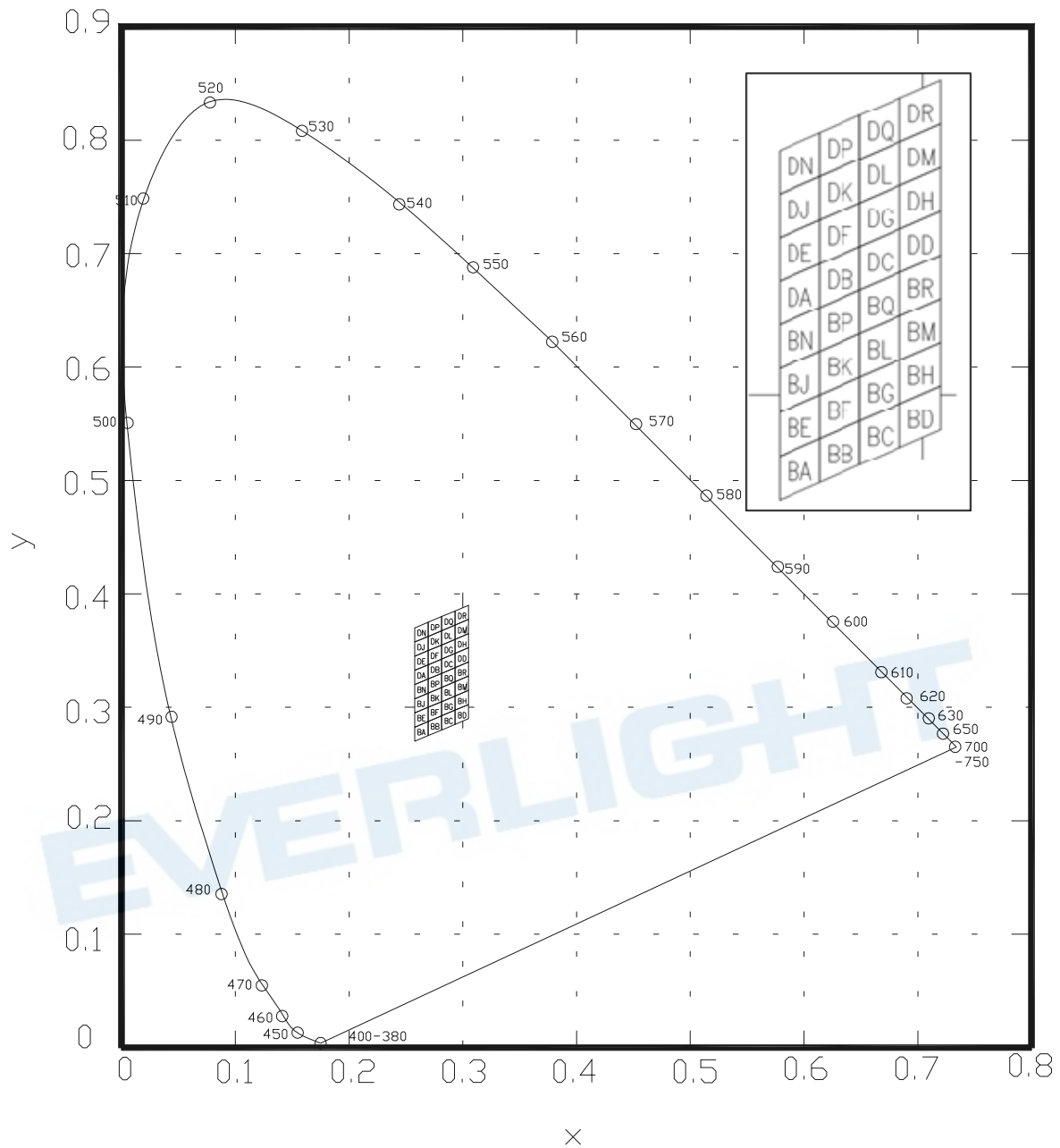

Typical Electro-Optical Characteristics Curves

R6

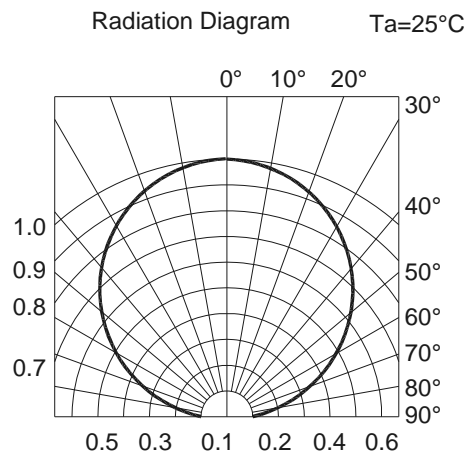
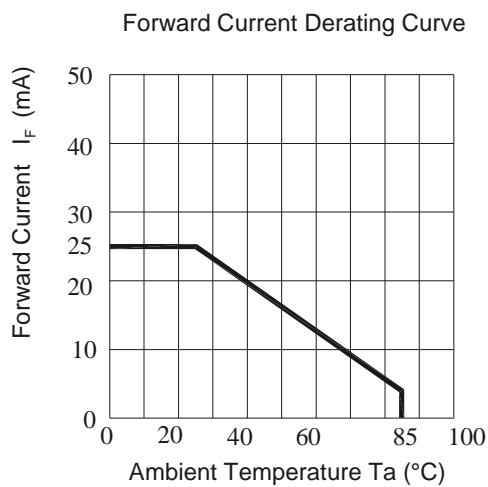
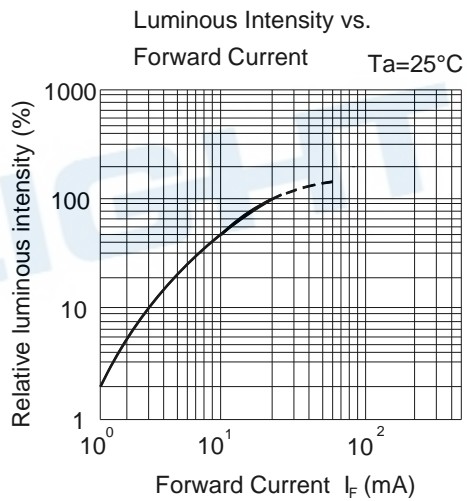
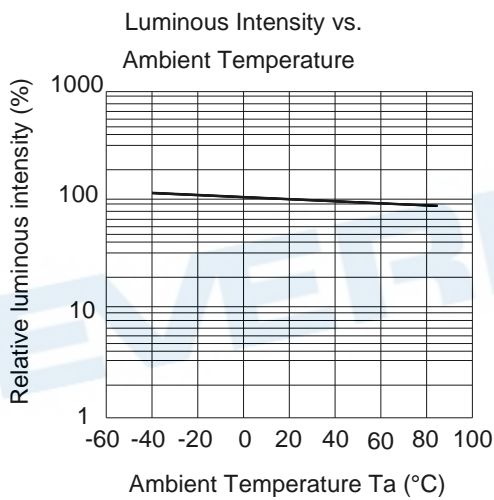
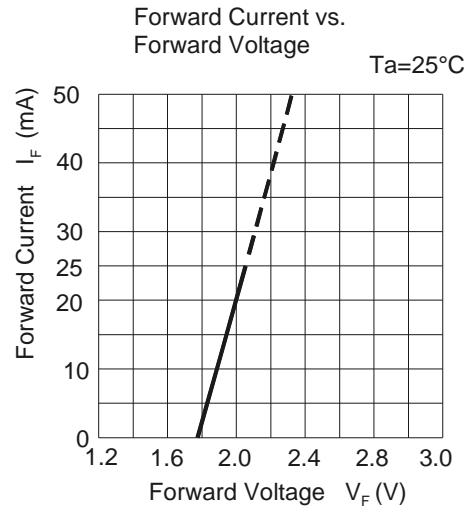
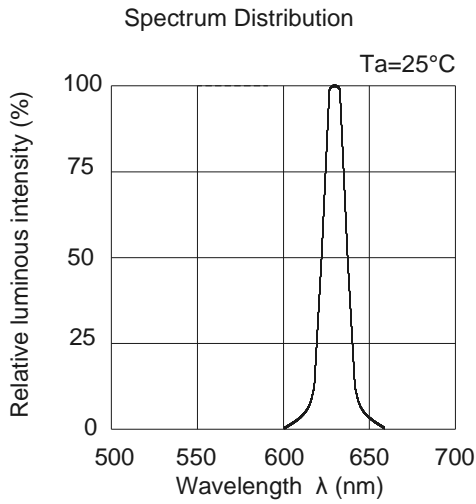

Typical Electro-Optical Characteristics Curves

GH

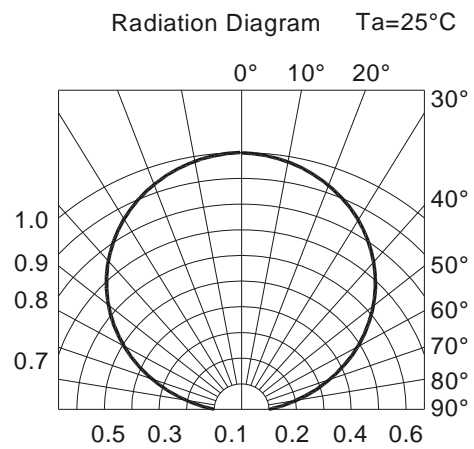
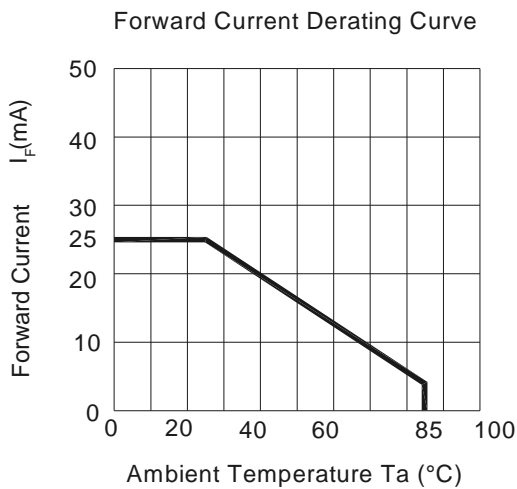
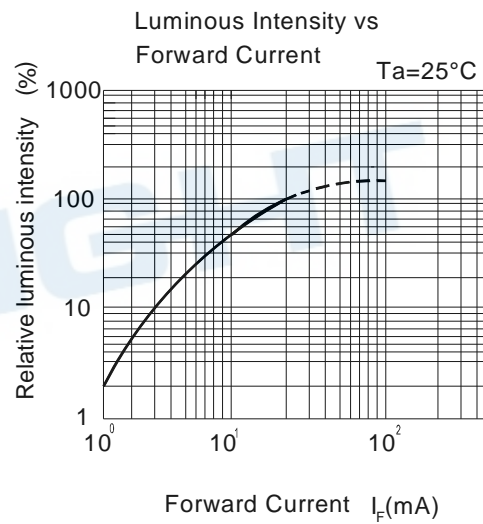
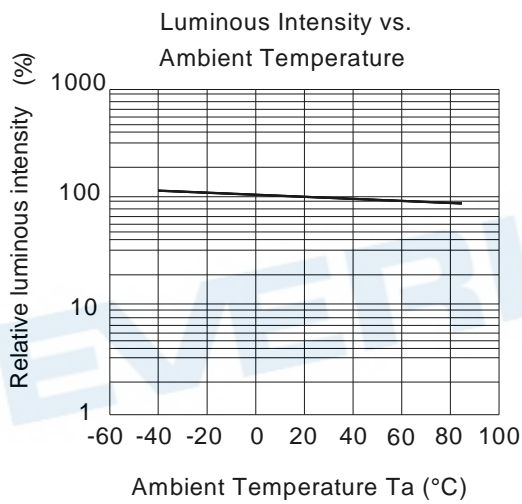
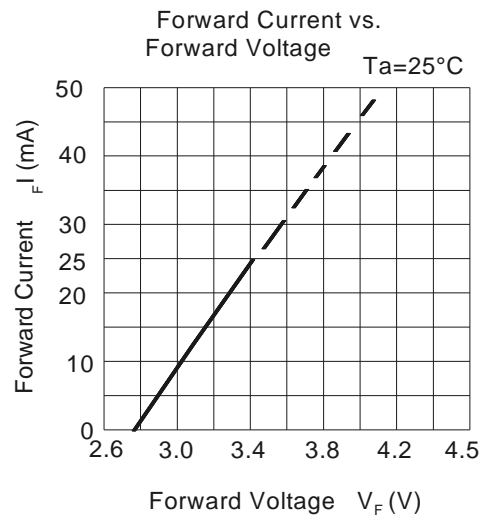
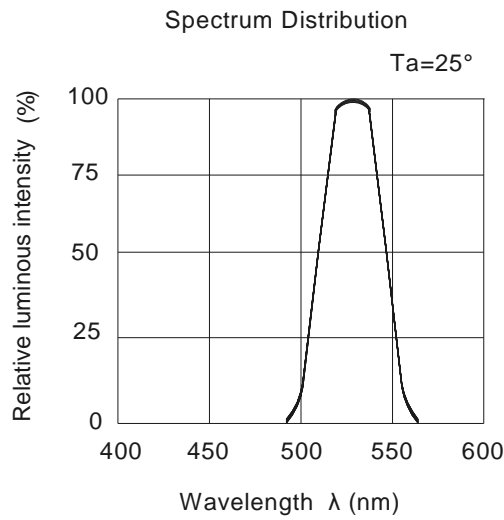

Typical Electro-Optical Characteristics Curves

BH

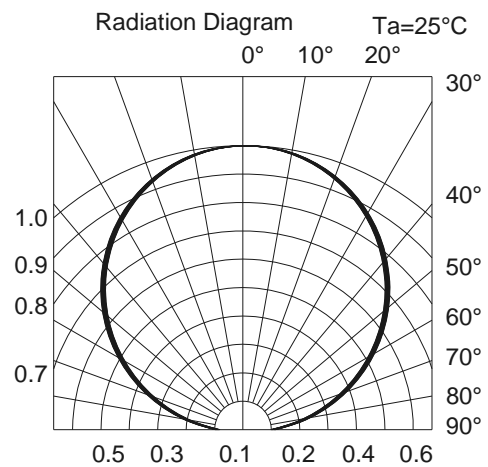
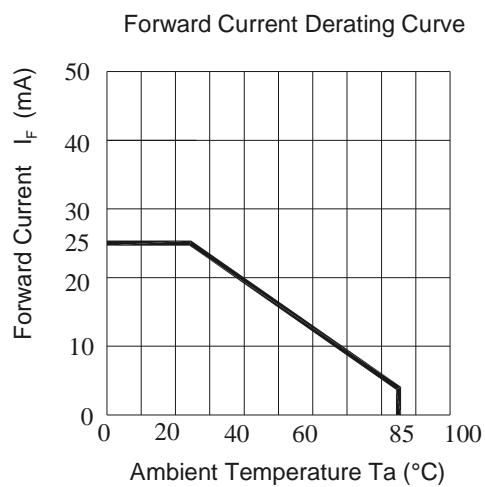
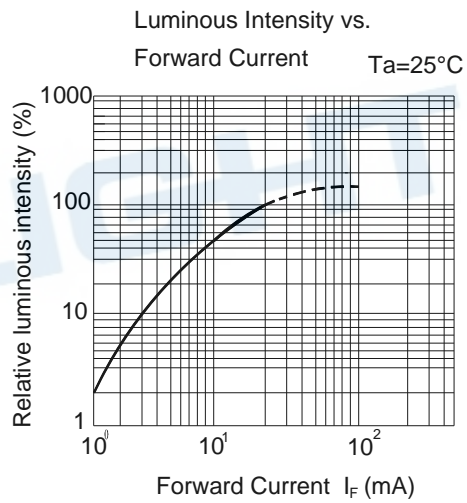
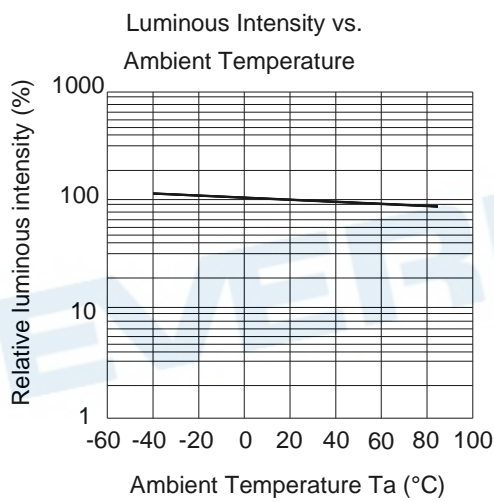
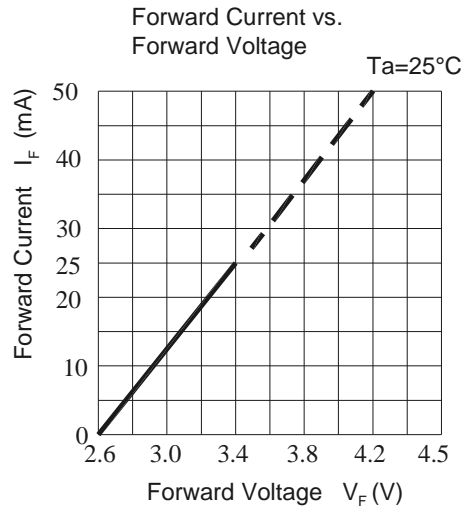
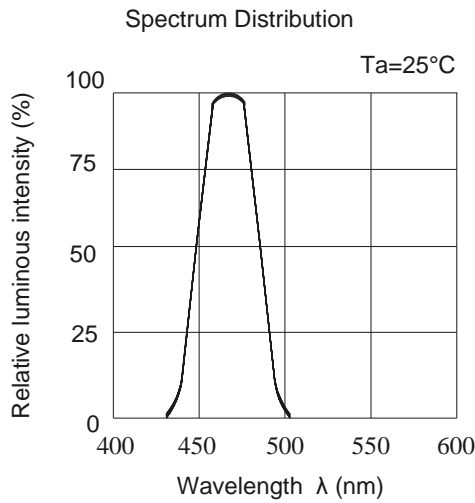

Package Dimension

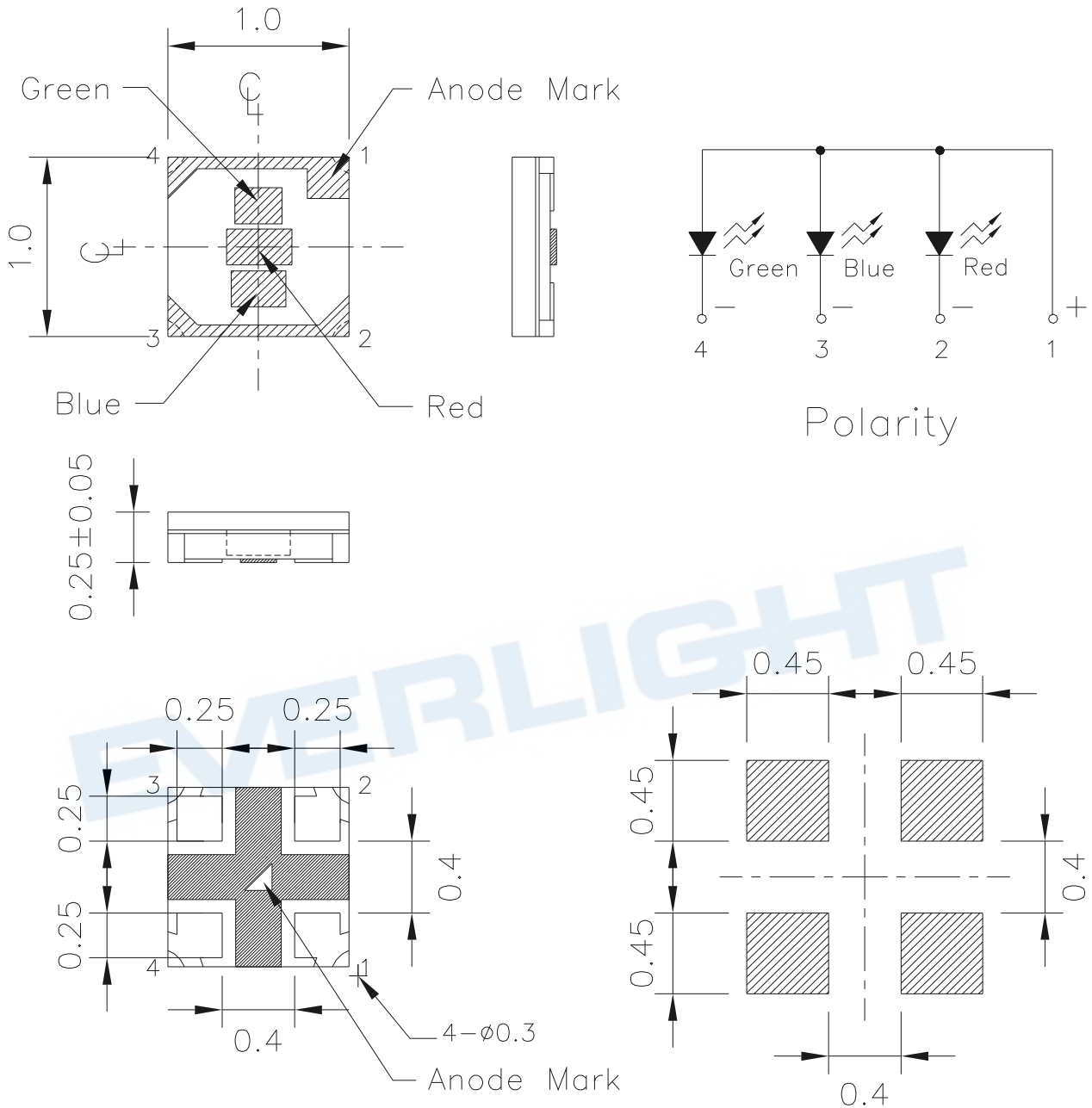

Note: Tolerances unless mentioned  $\pm 0.1$  mm. Unit = mm

Suggested pad dimension is just for reference only.  
 Please modify the pad dimension based on individual need.

Moisture Resistant Packing Materials

Label Explanation

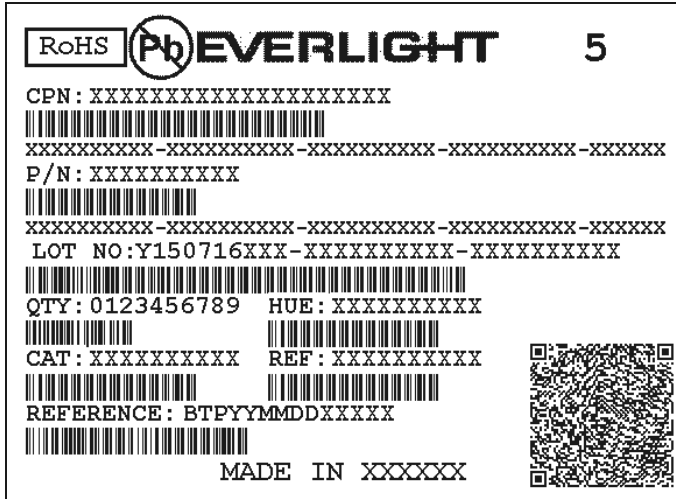

- CPN: Customer's Product Number
- P/N: Product Number
- QTY: Packing Quantity
- CAT: Luminous Intensity Rank
- HUE: Chromaticity Coordinates & Dom. Wavelength Rank
- REF: Forward Voltage Rank
- LOT No: Lot Number

Reel Dimensions

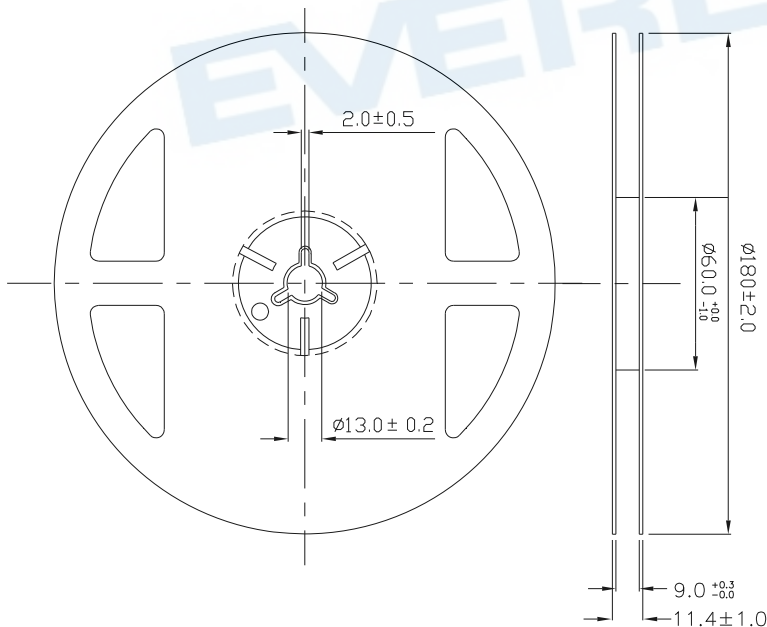

Note: The tolerances unless mentioned is  $\pm 0.1\text{mm}$  ,Unit = mm

**Carrier Tape Dimensions: Loaded quantity 2000 PCS per reel. The rest quantity which could not reach 2000 pcs per reel will goes to 1300 pcs per reel.**

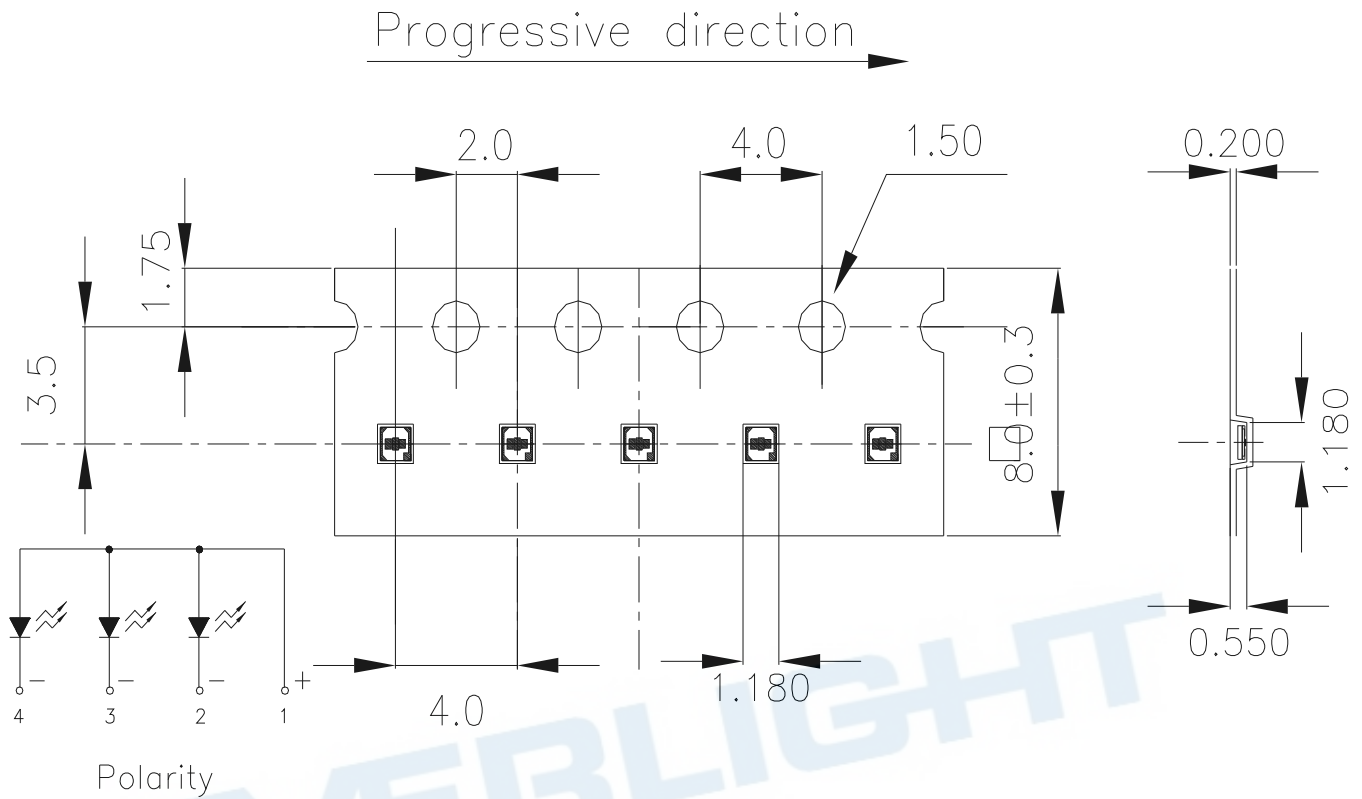

Note: The tolerances unless mentioned is  $\pm 0.1\text{mm}$ , Unit = mm

### Moisture Resistant Packaging

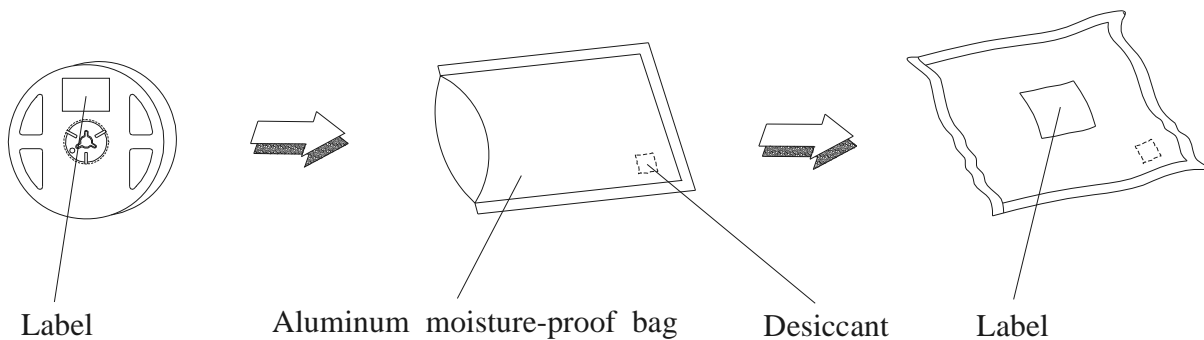

## Precautions For Use

### 1. Over-current-proof

Customer must apply resistors for protection, otherwise slight voltage shift will cause big current change ( Burn out will happen ).

### 2. Storage

2.1 Do not open moisture proof bag before the products are ready to use.

2.2 Before opening the package: The LEDs should be kept at 30°C or less and 90%RH or less.

2.3 After opening the package: The LED's floor life is 1 year under 30°C or less and 60% RH or less.

If unused LEDs remain, it should be stored in moisture proof packages.

2.4 If the moisture absorbent material (silica gel) has faded away or the LEDs have exceeded the storage time, baking treatment should be performed using the following conditions.

Baking treatment : 60±5°C for 24 hours.

### 3. Soldering Condition

#### 3.1 Pb-free solder temperature profile

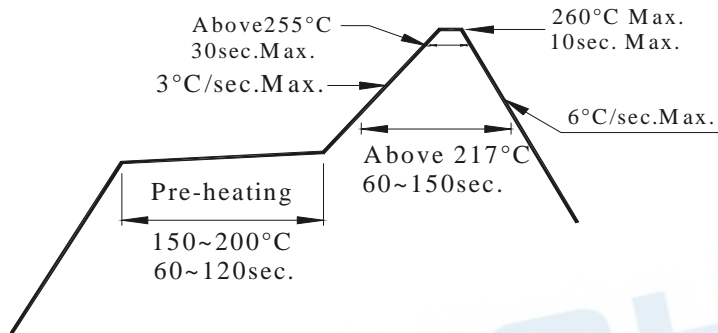

3.2 Reflow soldering should not be done more than two times.

3.3 When soldering, do not put stress on the LEDs during heating.

3.4 After soldering, do not warp the circuit board.

#### 4. Soldering Iron

Each terminal is to go to the tip of soldering iron temperature less than 350°C for 3 seconds within once in less than the soldering iron capacity 25W. Leave two seconds and more intervals, and do soldering of each terminal. Be careful because the damage of the product is often started at the time of the hand solder.

#### 5. Repairing

Repair should not be done after the LEDs have been soldered. When repairing is unavoidable, a double-head soldering iron should be used (as below figure). It should be confirmed beforehand whether the characteristics of the LEDs will or will not be damaged by repairing.

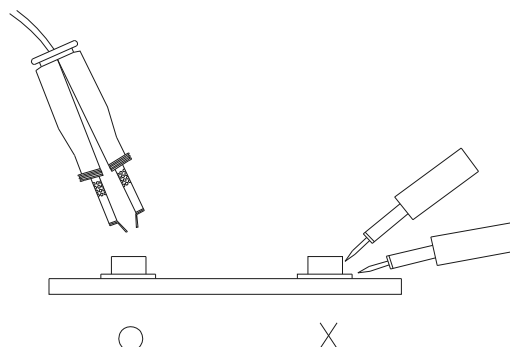



## Application Restrictions

High reliability applications such as military/aerospace, automotive safety/security systems, and medical equipment may require different product. If you have any concerns, please contact Everlight before using this product in your application. This specification guarantees the quality and performance of the product as an individual component. Do not use this product beyond the specification described in this document.

## DISCLAIMER

1. EVERLIGHT reserves the right(s) on the adjustment of product material mix for the specification.
2. The product meets EVERLIGHT published specification for a period of twelve (12) months from date of shipment.
3. The graphs shown in this datasheet are representing typical data only and do not show guaranteed values.
4. When using this product, please observe the absolute maximum ratings and the instructions for using outlined in these specification sheets. EVERLIGHT assumes no responsibility for any damage resulting from the use of the product which does not comply with the absolute maximum ratings and the instructions included in these specification sheets.
5. These specification sheets include materials protected under copyright of EVERLIGHT. Reproduction in any form is prohibited without obtaining EVERLIGHT's prior consent.
6. This product is not intended to be used for military, aircraft, automotive, medical, life sustaining or life saving applications or any other application which can result in human injury or death. Please contact authorized Everlight sales agent for special application request.

EVERLIGHT