

# FAN5345

## Series Boost LED Driver with Single-Wire Digital Interface

### Features

- Asynchronous Boost Converter
- Drives LEDs in Series:
  - FAN5345S20X: 20V Output
  - FAN5345S30X: 30V Output
- 2.5V to 5.5V Input Voltage Range
- Single-Wire Digital Control Interface to Set LED Brightness Levels
  - 32 Linear Steps
- 1.2MHz Fixed Switching Frequency
- Soft-Start Capability
- Input Under-Voltage Lockout (UVLO)
- Output Over-Voltage Protection (OVP)
- Short-Circuit Detection
- Thermal Shutdown (TSD) Protection
- Small Form-Factor 6-Lead SSOT23 Package

### Applications

- Cellular Mobile Handsets
- Mobile Internet Devices
- Portable Media Players
- PDA, DSC, MP3 Players

### Description

The FAN5345 is an asynchronous constant-current LED driver that drives LEDs in series to ensure equal brightness for all the LEDs. FAN5345S20X has an output voltage of 20V and can drive up to 5 LEDs in series. FAN5345S30X has an output voltage of 30V and drive up to 8 LEDs in series. Optimized for small form-factor applications, the 1.2MHz fixed switching frequency allows the use of small inductors and capacitors.

The FAN5345 uses a simple single-wire digital control interface to program the brightness levels of the LEDs in 32 linear steps by applying digital pulses.

For safety, the device features integrated over-voltage, over-current, short-circuit detection, and thermal-shutdown protection. In addition, input under-voltage lockout protection is triggered if the battery voltage is too low.

The FAN5345 is available in a 6-lead SSOT23 package. It is “green” and RoHS compliant. (Please see <http://www.fairchildsemi.com/company/green/index.html> for Fairchild's definition of green).

### Ordering Information

Part Number	Output Voltage Option	Temperature Range	Package
FAN5345S20X	20V	-40 to 85°C	6-Lead, Super-SOT™-6, JEDEC MO-193, 1.6mm Wide (MA06A)
FAN5345S30X	30V		

Typical Application Diagram

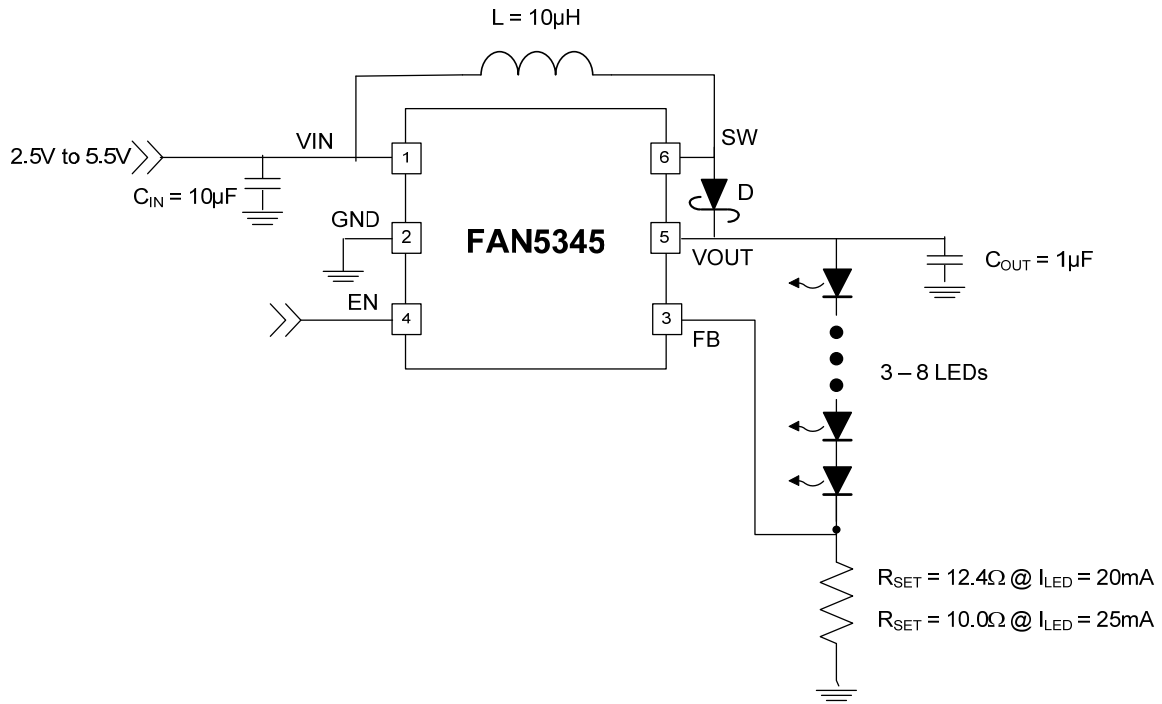

Figure 1. Typical Application

Block Diagram

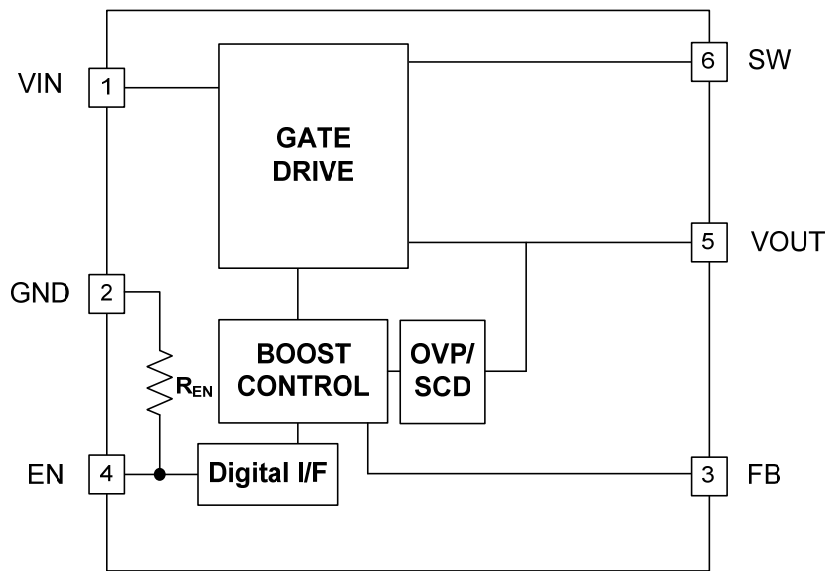

Figure 2. Functional Block Diagram

## Pin Configuration

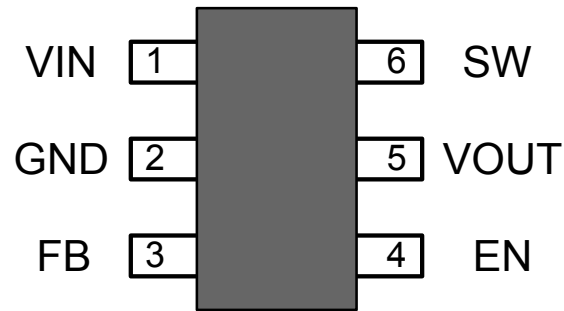

Figure 3. Pin Assignments Top View

## Pin Definitions

Pin #	Name	Description
5	VOUT	<b>Boost Output Voltage.</b> Output of the boost regulator. Connect the LEDs to this pin. Connect $C_{OUT}$ (output capacitor) to GND.
1	VIN	<b>Input Voltage.</b> Connect to power source and decouple with $C_{IN}$ to GND.
4	EN	<b>Enable Brightness Control.</b> Program dimming levels by driving pin with digital pulses.
3	FB	<b>Voltage Feedback.</b> The boost regulator regulates this pin to 0.250V to control the LED string current. Tie this pin to a current setting resistor ( $R_{SET}$ ) between GND and the cathode of the LED string.
6	SW	<b>Switching Node.</b> Tie inductor L1 from VIN to SW pin.
2	GND	<b>Ground.</b> Tie directly to a GND plane.

## Absolute Maximum Ratings

Stresses exceeding the absolute maximum ratings may damage the device. The device may not function or be operable above the recommended operating conditions and stressing the parts to these levels is not recommended. In addition, extended exposure to stresses above the recommended operating conditions may affect device reliability. The absolute maximum ratings are stress ratings only.

Symbol	Parameter	Min.	Max.	Unit	
$V_{IN}$	VIN Pin	-0.3	6.0	V	
$V_{FB}, V_{EN}$	FB, EN Pins	-0.3	$V_{IN} + 0.3$	V	
$V_{SW}$	SW Pin	FAN5345S20X	-0.3	22.0	V
		FAN5345X30X	-0.3	33.0	V
$V_{OUT}$	VOUT Pin	FAN5345S20X	-0.3	22.0	V
		FAN5345X30X	-0.3	33.0	V
ESD	Electrostatic Discharge Protection	Human Body Model per JESD22-A114	1.5		kV
		Charged Device Model per JESD22-C101	1.5		
$T_J$	Junction Temperature	-40	+150	°C	
$T_{STG}$	Storage Temperature	-65	+150	°C	
$T_L$	Lead Soldering Temperature, 10 Seconds		+260	°C	

## Recommended Operating Conditions

The Recommended Operating Conditions table defines the conditions for actual device operation. Recommended operating conditions are specified to ensure optimal performance to the datasheet specifications. Fairchild does not recommend exceeding them or designing to absolute maximum ratings.

Symbol	Parameter	Comments	Min.	Max.	Unit
$V_{IN}$	$V_{IN}$ Supply Voltage		2.5	5.5	V
$V_{OUT}$	$V_{OUT}$ Voltage <sup>(1)</sup>	FAN5345S20X	6.2	18.5	V
		FAN5345S30X	6.2	28.5	
$I_{OUT}$	$V_{OUT}$ Load Current		5	25	mA
$T_A$	Ambient Temperature		-40	+85	°C
$T_J$	Junction Temperature		-40	+125	°C

### Note:

- The application should guarantee that minimum and maximum duty cycle should fall between 20-85% to meet the specified range.

## Thermal Properties

Junction-to-ambient thermal resistance is a function of application and board layout. This data is measured with four-layer 2s2p boards in accordance to JEDEC standard JESD51. Special attention must be paid not to exceed junction temperature  $T_{J(max)}$  at a given ambient temperature  $T_A$ .

Symbol	Parameter	Typical	Unit
$\theta_{JA6}$	Junction-to-Ambient Thermal Resistance, SSOT23-6 Package	151	°C/W

## Electrical Specifications

$V_{IN} = 2.5V$  to  $5.5V$  and  $T_A = -40^{\circ}C$  to  $+85^{\circ}C$  unless otherwise noted. Typical values are at  $T_A = +25^{\circ}C$  and  $V_{IN} = 3.6V$ .

Symbol	Parameter	Conditions	Min.	Typ.	Max.	Unit
<b>Power Supplies</b>						
$I_{SD}$	Shutdown Supply Current	EN = GND		0.30	0.90	$\mu A$
$I_{Q(ACTIVE)}$	Quiescent Current at $I_{LOAD} = 0mA$	Device Not Switching, No Load		300		$\mu A$
$V_{UVLO}$	Under-Voltage Lockout Threshold	$V_{IN}$ Rising	2.10	2.35	2.60	V
		$V_{IN}$ Falling	1.80	2.05	2.30	
$V_{UVHYST}$	Under-Voltage Lockout Hysteresis			250		mV
<b>EN: Enable Pin</b>						
$V_{IH}$	HIGH-Level Input Voltage		1.2			V
$V_{IL}$	LOW-Level Input Voltage				0.4	V
$R_{EN}$	EN Pull-Down Resistance		200	300	400	$k\Omega$
$T_{LO}$	EN Low Time for Dimming <sup>(3)</sup>	$V_{IN} = 3.6V$ ; Figure 28	0.5		300	$\mu s$
$T_{HI}$	Delay Between Steps <sup>(3)</sup>	$V_{IN} = 3.6V$ ; Figure 28	0.5			$\mu s$
$T_{SD}$	EN Low, Shutdown Pulse Width	$V_{IN} = 3.6V$ ; from Falling Edge of EN			1	ms
<b>Feedback and Reference</b>						
$V_{FB}$	Feedback Voltage	$I_{LED} = 20mA$ from $-40^{\circ}C$ to $+85^{\circ}C$ , $2.7V \leq V_{IN} \leq 5.5V$	230	250	270	mV
$I_{FB}$	Feedback Input Current	$V_{FB} = 250mV$		0.1	1.0	$\mu A$
<b>Power Outputs</b>						
$R_{DS(ON)_Q1}$	Boost Switch On Resistance	$V_{IN} = 3.6V$ , $I_{SW} = 100mA$		600		m $\Omega$
		$V_{IN} = 2.5V$ , $I_{SW} = 100mA$		650		
$I_{SW(OFF)}$	SW Node Leakage <sup>(2)</sup>	EN = 0, $V_{IN} = V_{SW} = V_{OUT} = 5.5V$ , $V_{LED} = 0V$		0.1	2.0	$\mu A$
$I_{LIM-PK}$	Boost Switch Peak Current Limit	FAN5345S20X: $V_{IN} = 3.2V$ to $4.3V$ , $T_A = 20^{\circ}C$ to $+60^{\circ}C$ , $V_F = 3.4V$ , 4 LEDs	200	300	400	mA
		FAN5345S30X	500	750	1000	
<b>Oscillator</b>						
$f_{SW}$	Boost Regulator Switching Frequency		0.95	1.15	1.35	MHz
<b>Output and Protection</b>						
$V_{OVP}$	Boost Output Over-Voltage Protection	FAN5345S20X	18.0	20.0	21.5	V
		FAN5345S30X	27.5	30.0	32.5	
	OVP Hysteresis	FAN5345S20X		0.8		
		FAN5345S30X		1.0		
$V_{TLSC}$	$V_{OUT}$ Short-Circuit Detection Threshold	$V_{OUT}$ Falling		$V_{IN} - 1.4$		V
$V_{THSC}$	$V_{OUT}$ Short-Circuit Detection Threshold	$V_{OUT}$ Rising		$V_{IN} - 1.2$		V
$D_{MAX}$	Maximum Boost Duty Cycle <sup>(3,4)</sup>		85			%
$D_{MIN}$	Minimum Boost Duty Cycle <sup>(3,4)</sup>				20	
$T_{TSD}$	Thermal Shutdown			150		$^{\circ}C$
$T_{HYS}$	Thermal Shutdown Hysteresis			35		$^{\circ}C$

### Notes:

- SW leakage current includes the leakage current of two internal switches; SW to GND and SW to  $V_{OUT}$ .
- Not tested in production; guaranteed by design.
- Application should guarantee that minimum and maximum duty cycle fall between 20-85% to meet the specified range.

## Typical Characteristics

$V_{IN} = 3.6V$ ,  $T_A = 25^\circ C$ ,  $I_{LED} = 25mA$ ,  $L = 10\mu H$ ,  $C_{OUT} = 1.0\mu F$ , and  $C_{IN} = 10.0\mu F$ .

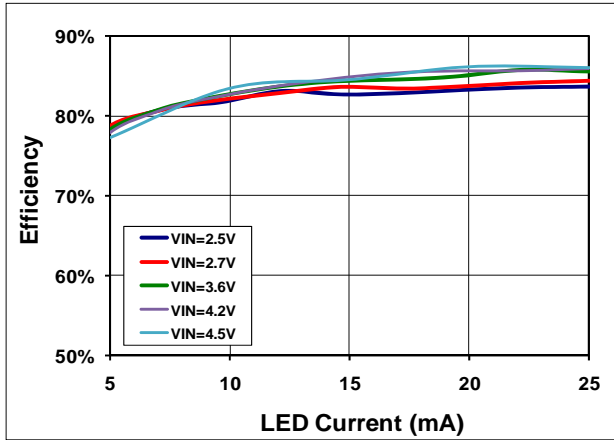

Figure 4. 3 LEDs: Efficiency vs. LED Current vs. Input Voltage

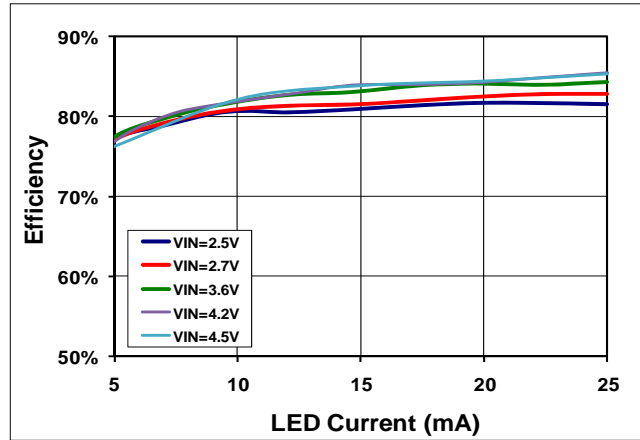

Figure 5. 4 LEDs: Efficiency vs. LED Current vs. Input Voltage

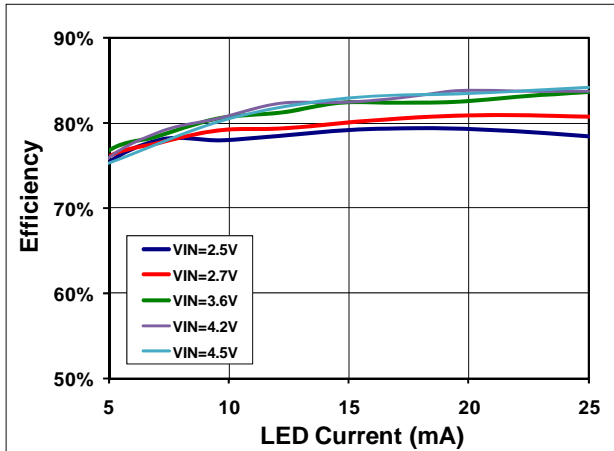

Figure 6. 5 LEDs: Efficiency vs. LED Current vs. Input Voltage

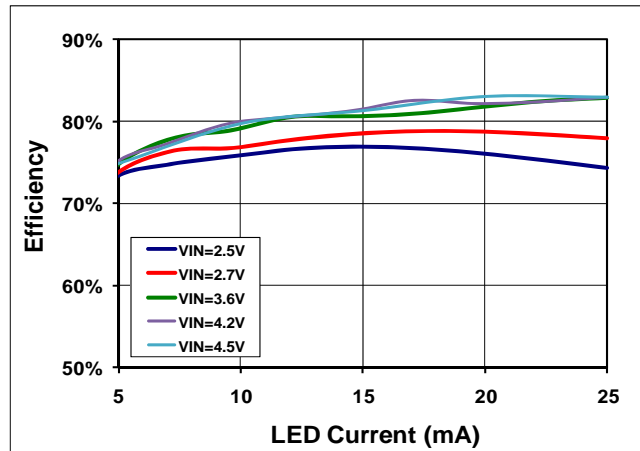

Figure 7. 6 LEDs: Efficiency vs. LED Current vs. Input Voltage

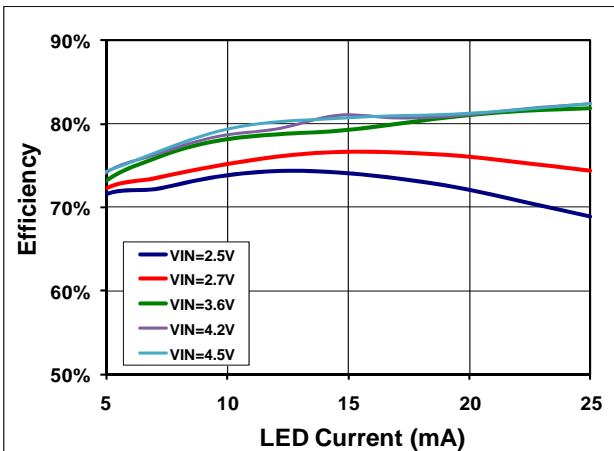

Figure 8. 7 LEDs: Efficiency vs. LED Current vs. Input Voltage

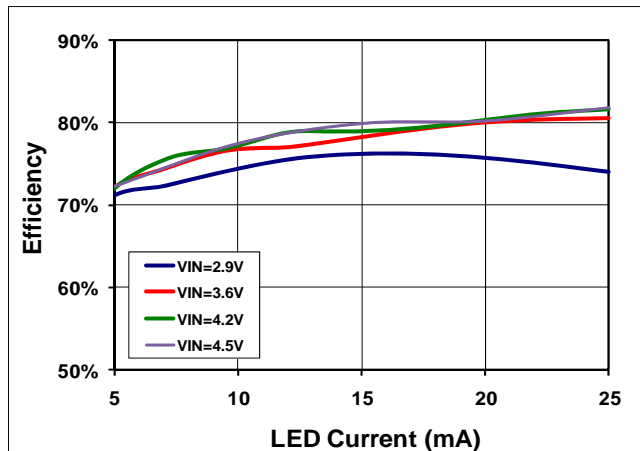

Figure 9. 8 LEDs: Efficiency vs. LED Current vs. Input Voltage

## Typical Characteristics

$V_{IN} = 3.6V$ ,  $T_A = 25^\circ C$ ,  $I_{LED} = 25mA$ ,  $L = 10\mu H$ ,  $C_{OUT} = 1.0\mu F$ , and  $C_{IN} = 10.0\mu F$ .

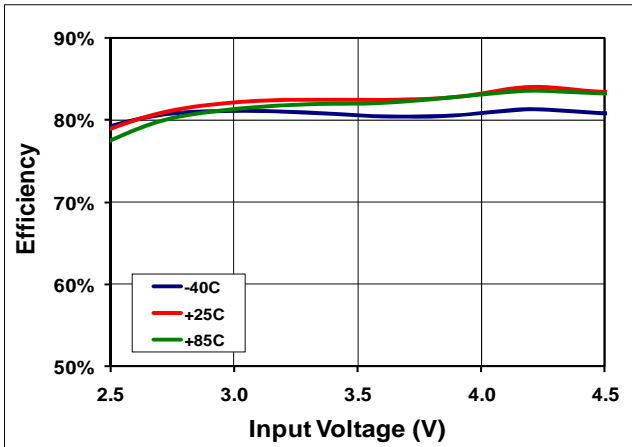

Figure 10. Efficiency vs. Input Voltage vs. Temperature for 5 LEDs in Series

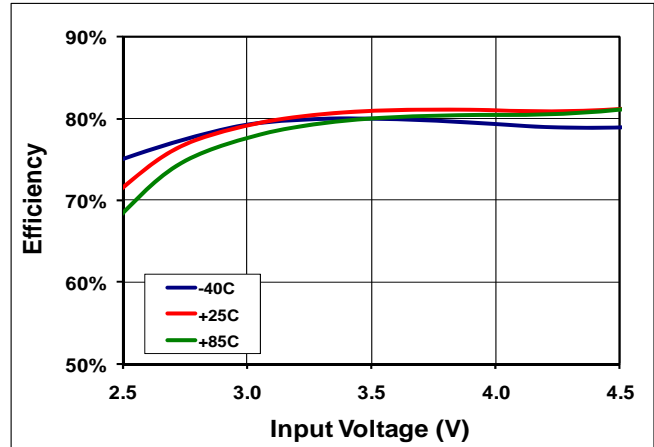

Figure 11. Efficiency vs. Input Voltage vs. Temperature for 7 LEDs in Series

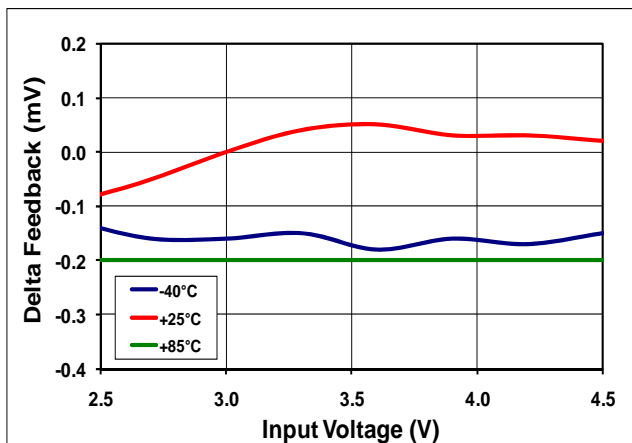

Figure 12. Delta of  $V_{FB}$  Over Input Voltage and Temperature for 7 LEDs with  $L=10\mu H$  and  $C_{OUT}=1.0\mu F$

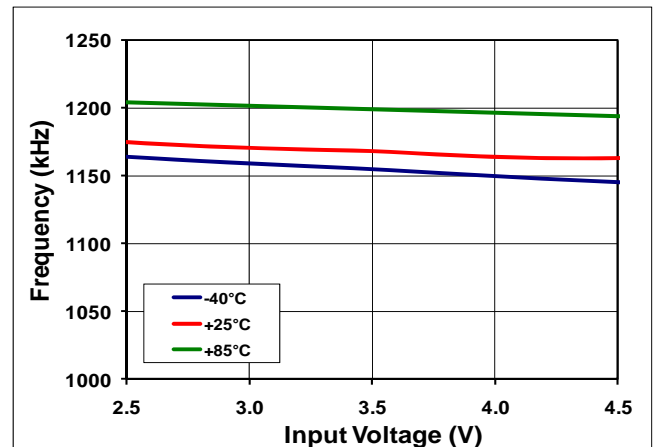

Figure 13. Frequency vs. Input Voltage vs. Temperature

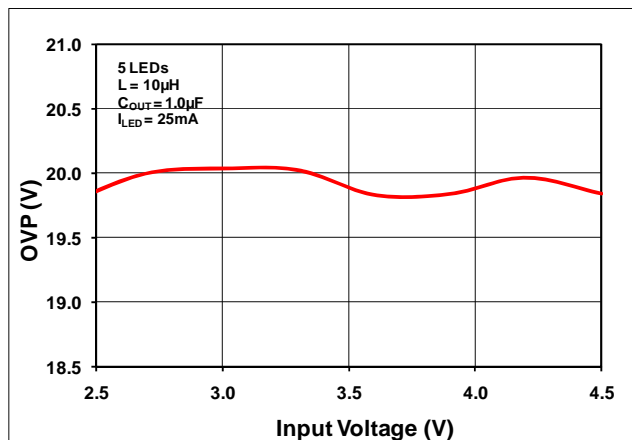

Figure 14. OVP vs. Input Voltage: FAN5345S20X

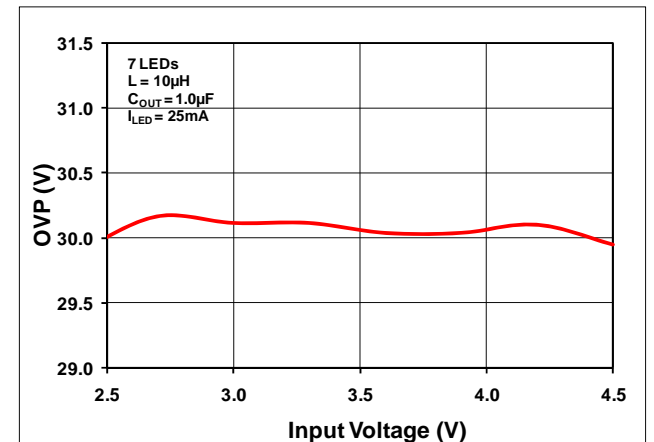

Figure 15. OVP vs. Input Voltage: FAN5345S30X

## Typical Characteristics

$V_{IN} = 3.6V$ ,  $T_A = 25^\circ C$ ,  $I_{LED} = 25mA$ ,  $L = 10\mu H$ ,  $C_{OUT} = 1.0\mu F$ , and  $C_{IN} = 10.0\mu F$ .

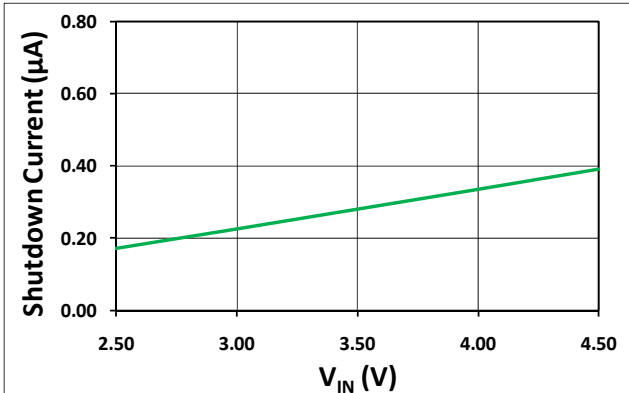

Figure 16. Shutdown Current vs. Input Voltage

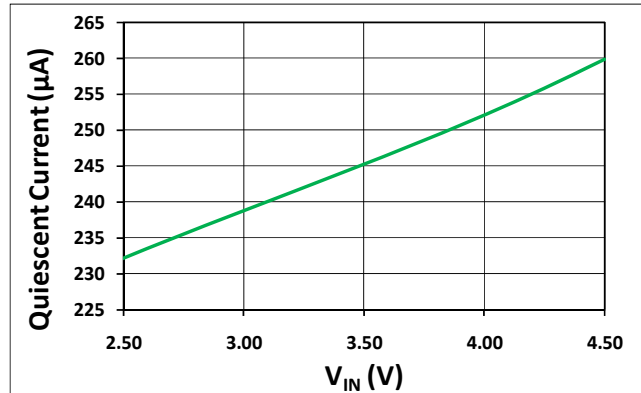

Figure 17. Quiescent Current vs. Input Voltage

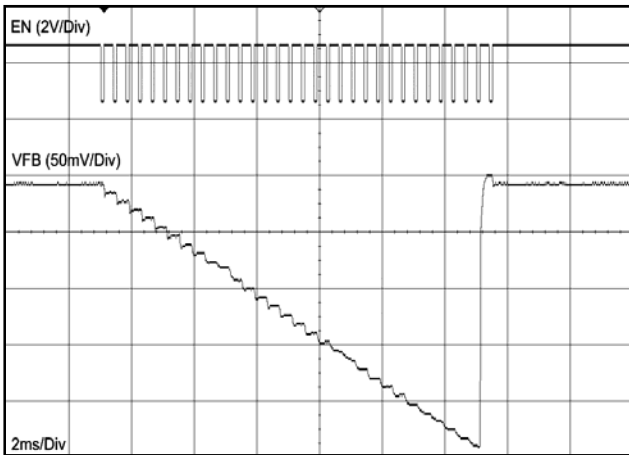

Figure 18. Dimming Operation

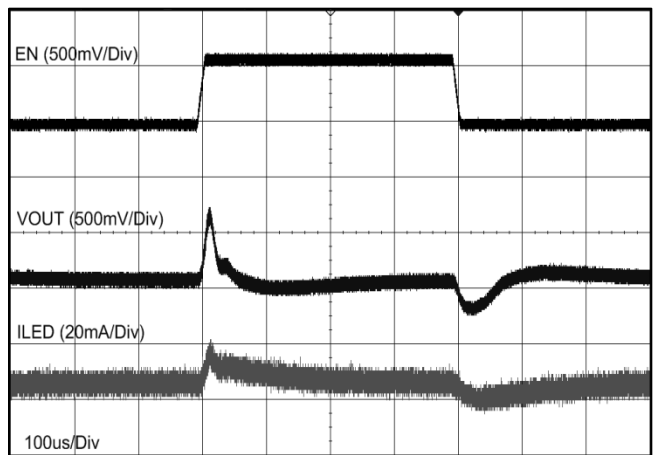

Figure 19. Line Transient Response for 5 LEDs

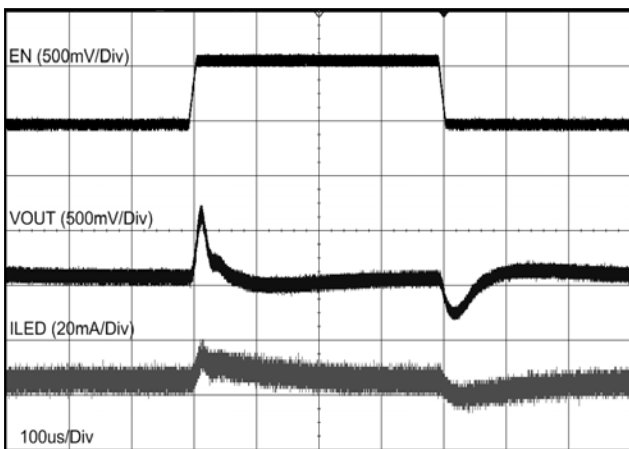

Figure 20. Line Transient Response for 6 LEDs

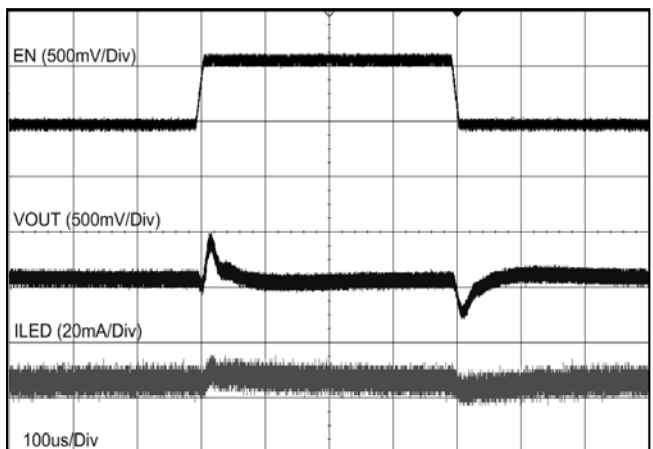
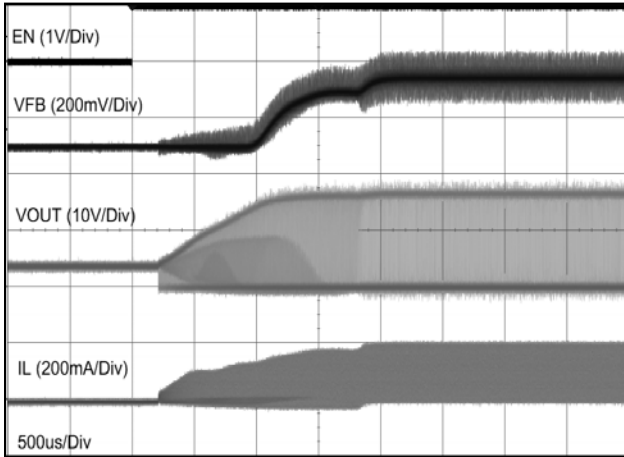

Figure 21. Line Transient Response for 7 LEDs



## Typical Characteristics

$V_{IN} = 3.6V$ ,  $T_A = 25^\circ C$ ,  $I_{LED} = 25mA$ ,  $L = 10\mu H$ ,  $C_{OUT} = 1.0\mu F$ , and  $C_{IN} = 10.0\mu F$ .



**Figure 22. Startup Waveform for Switch Voltage, Inductor Current,  $V_{FB}$ , and EN for 5 LEDs**

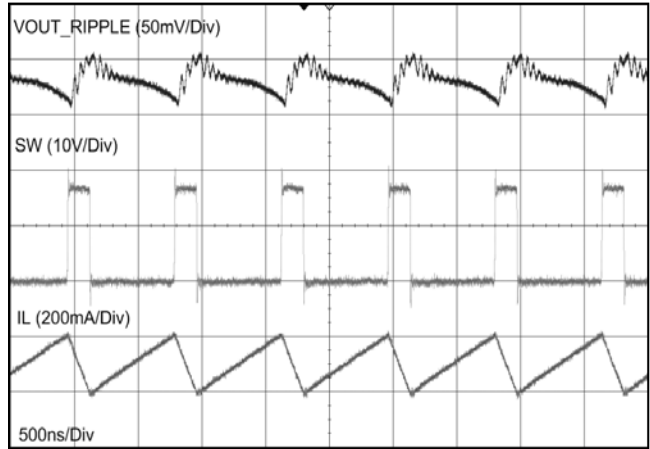

**Figure 23. Steady-State Waveform for  $V_{OUT}$ , Switch Voltage, and Inductor Current for 5 LEDs**

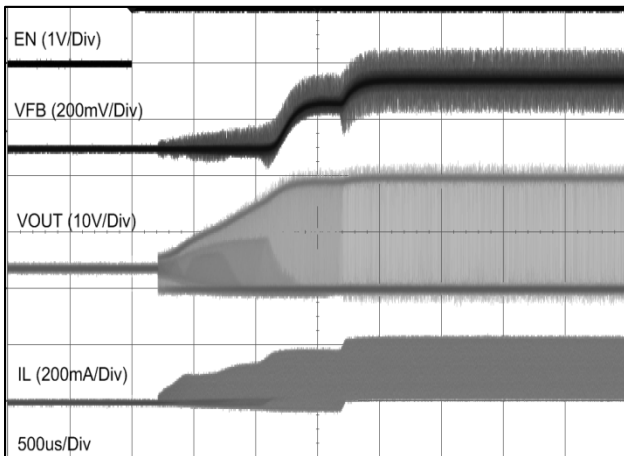

**Figure 24. Startup Waveform for Switch Voltage, Inductor Current,  $V_{FB}$ , and EN for 6 LEDs**

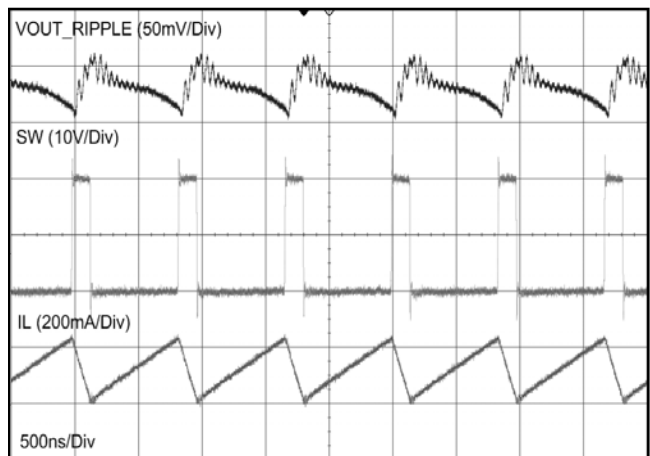

**Figure 25. Steady-State Waveform for  $V_{OUT}$ , Switch Voltage, and Inductor Current for 6 LEDs**

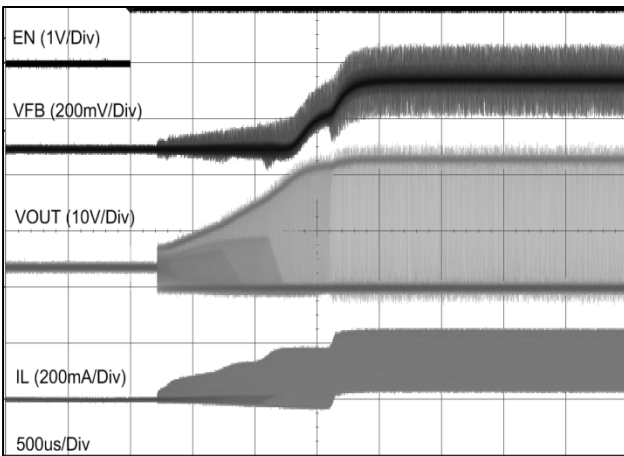

**Figure 26. Startup Waveform for Switch Voltage, Inductor Current,  $V_{FB}$ , and EN for 7 LEDs**

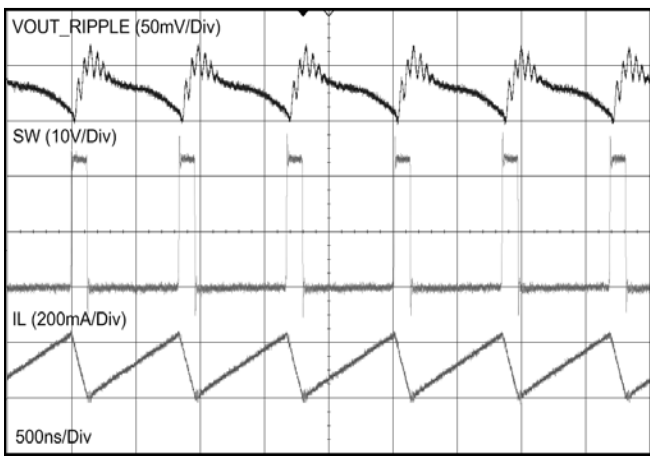

**Figure 27. Steady-State Waveform for  $V_{OUT}$ , Switch Voltage, and Inductor Current for 7 LEDs**

## Circuit Description

### Overview

The FAN5345 is an inductive current-mode boost serial LED driver that achieves LED current regulation by maintaining 0.250V across the  $R_{SET}$  resistor. The current through the LED string ( $I_{LED}$ ) is therefore given by:

$$I_{LED} = \frac{0.250}{R_{SET}} \quad (1)$$

The voltage  $V_{OUT}$  is determined by the sum of the forward voltages across each LED, plus the voltage across  $R_{SET}$ , which is always 250mV.

### UVLO and Soft-Start

If EN has been LOW for more than 1ms, the IC may initiate a “cold start” soft-start cycle when EN rises, provided  $V_{IN}$  is above the UVLO threshold.

### Driving Eight LEDs in Series

FAN5345S30X can drive 8 LEDs in series, but the minimum input voltage ( $V_{IN}$ ) must be greater than or equal to 2.9V while the forward voltage of the white LED should be less than or equal to 3.2V and the maximum LED current cannot exceed 20mA in order to maintain stable operation.

### Digital Interface

The FAN5345 implements a single-wire digital interface to program the LED brightness to one of thirty-two (32) levels spaced in linear steps. With this single-wire solution, the FAN5345 does not require the system processor to constantly supply a signal to drive the LEDs.

### Digital Dimming Control

The FAN5345 starts driving the LEDs at the maximum brightness level. After startup, the control logic is ready to accept programming pulses to decrease the brightness level by the number of positive edges applied to the EN pin. Figure 28. Digital Pulse-Dimming Control Diagram shows the digital pulse dimming control. The dimming control function has no effect before soft-start finishes. The soft-start takes about 2ms.

### Over-Current and Short-Circuit Detection

The boost regulator employs a cycle-by-cycle peak inductor current limit of 300mA (typical) and 750mA (typical) for FAN5345S20X and FAN5345S30X respectively.

### Over-Voltage / Open-Circuit Protection

If the LED string is an open circuit, FB remains at 0V and the output voltage continues to increase in the absence of an over-voltage protection (OVP) circuit. The FAN5345S20X OVP circuit disables the boost regulator when  $V_{OUT}$  exceeds 20.0V and continues to keep the regulator off until  $V_{OUT}$  drops below 19.0V. For FAN5345S30X, the OVP is 30.0V and it turns back on when  $V_{OUT}$  is below 29.0V.

### Thermal Shutdown

When the die temperature exceeds 150°C, a reset occurs and remains in effect until the die cools to 115°C; at which time, the circuit is allowed to begin the soft-start sequence.

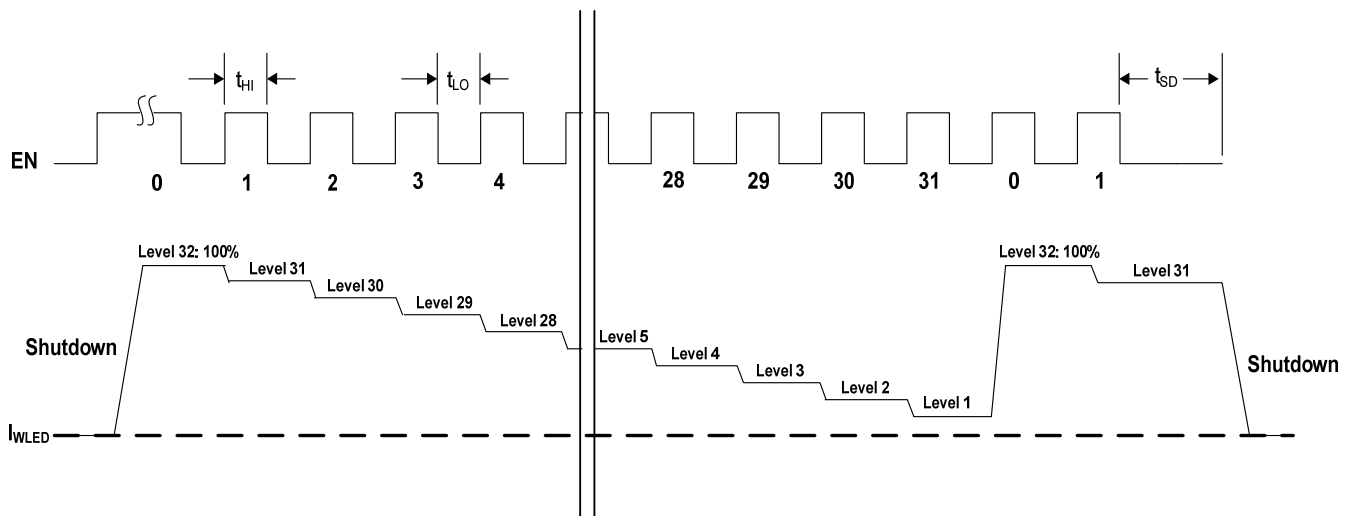

Figure 28. Digital Pulse-Dimming Control Diagram

## Application Information

The reference schematic diagram is shown in Figure 29. FAN5345 is able to drive up to eight LEDs with input voltage equal or greater than 2.9V ( $V_{IN} \geq 2.9V$ ). However, the number of LEDs that can be used depends on forward voltage. It is recommended that the forward voltage ( $V_F$ ) of

the white LEDs be no greater than 3.2V and the maximum LED current is 20mA. FAN5345 can be also used as a boost converter by connect the  $V_{OUT}$  point to the load directly. The return trace of the load should also return to GND through a sense resistor ( $R_1$ ).

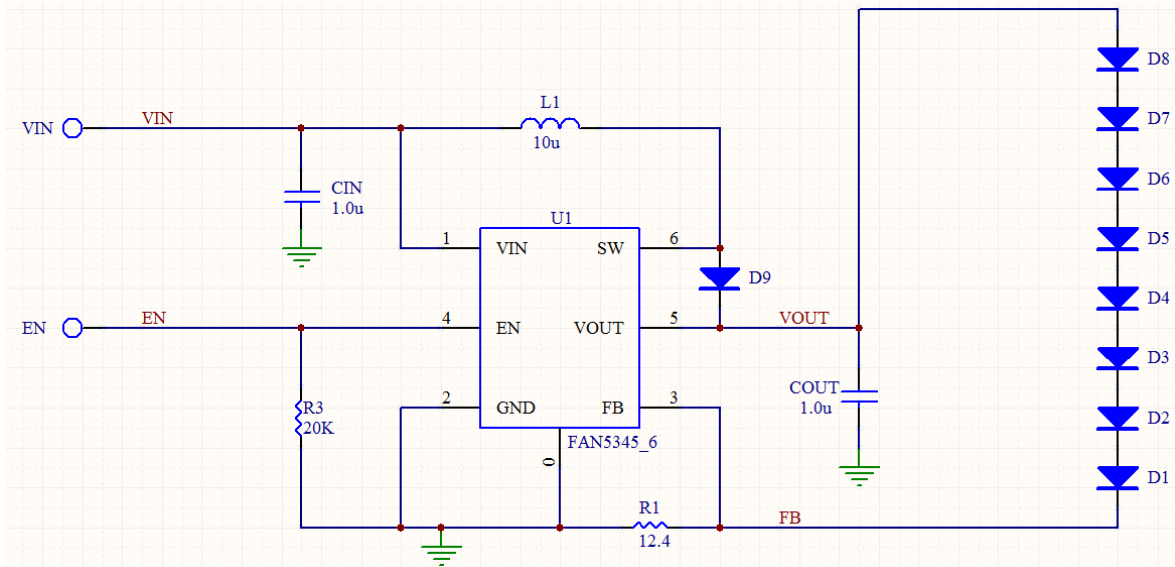

Figure 29. Reference Application Schematic Diagram

## Component Placement and PCB Recommendations

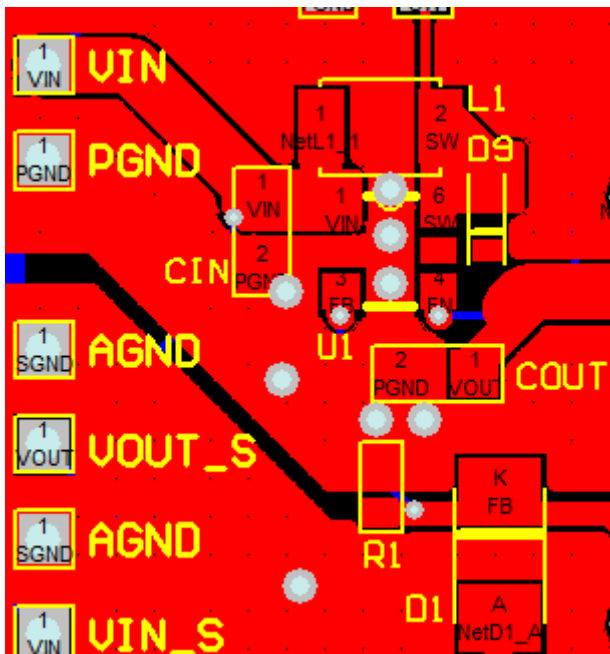

Figure 30. Reference PCB Layout

FAN5345 switches at 1.2MHz to boost the output voltage. Component placement and PCB layout need to be carefully taken into consideration to ensure stable output and to

prevent generation of noise. Figure 30 is the FAN5345 a portion of the evaluation board layout. The critical layout elements are: the  $L_1$ ,  $C_{IN}$ ,  $C_{IN}$  return trace,  $C_{OUT}$ , and the  $C_{OUT}$  return trace.

### Input Capacitor and Return Trace

The input capacitor is the first priority in a switching buck or boost regulator layout. A stable input source ( $V_{IN}$ ) enables a switching regulator to deliver its best performance. During the regulator's operation, it is switching at a high frequency, which makes the load of  $C_{IN}$  change dynamically to make the input source vary at the same switching frequency as the regulator. To ensure a stable input source,  $C_{IN}$  needs to hold enough energy to minimize the variation at the input pin of the regulator. For  $C_{IN}$  to have a fast response of charge / discharge, the trace from  $C_{IN}$  to the input pin of the regulator and the return trace from GND of the regulator to  $C_{IN}$  should be as short and wide as possible to minimize trace resistance, inductance, and capacitance. During operation, the current flow from  $C_{IN}$  through the regulator to the load and back to  $C_{IN}$  contains high-frequency variation due to switching. Trace resistance reduces the overall efficiency due to  $I^2R$  loss. Even a small trace inductance could effectively yield ground variation to add noise on  $V_{OUT}$ . The input capacitor should be placed close to the  $V_{IN}$  and GND pins of the regulator and traces should be as short as possible. Avoid routing the return trace through different layers because vias have strong inductance effect at high frequencies. If routing to other PCB layers is unavoidable, place vias next to the  $V_{IN}$  and GND pins of the regulator to minimize the trace distance.

### Output Capacitor and Return Trace

The output capacitor serves the same purpose as the input capacitor, but also maintains a stable output voltage. As explained above, the current travels to the load and back to the  $C_{OUT}$  GND terminal.  $C_{OUT}$  should be placed close to the VOUT pin. The traces of  $C_{OUT}$  to L1, VOUT, and return from load to  $C_{OUT}$  should be as short and wide as possible to minimize trace resistance and inductance. To minimize noise coupling to load, a small-value capacitor can be placed between VOUT and  $C_{OUT}$  to route high-frequency noise back to GND before it gets to the load.

### Inductor

Inductor (L1) should be placed as close to the regulator as possible to minimize trace resistance and inductance for the reasons explained above.

### Sense Resistor

The sense resistor provides a feedback signal for the regulator to control output voltage. A long trace from the sense resistor to the FB pin couples noise into the FB pin. If noise is coupled into the FB pin, it causes unstable operation of the switching regulator, which affects application performance. The return trace from the sense resistor to the FB pin should be short and away from any fast-switching signal traces. The ground plane under the return trace is necessary. If the ground plane under the return trace is noisy, but not the same ground plane as the regulator, the noise could be coupled into the FB pin through PCB parasitic capacitance, yielding noisy output.

In Figure 30;  $C_{IN}$ ,  $C_{OUT}$ , and L1 are all placed next to the regulator. All traces are on the same layer to minimize trace resistance and inductance. Total PCB area, not including the sense resistor, is  $67.2\text{mm}^2$  (7.47mm x 8.99mm).

**Table 1. Recommended External Components**

	Part Number	Manufacturer
<b>Inductor (L)</b>		
10.0 $\mu$ H	LQH43MN100K03	Murata
	NLCV32T-100K-PFR	TDK
	VLF3010AT-100MR49-1	TDK
	DEM2810C 1224-AS-H-100M	TOKO
<b>Minimum <math>C_{OUT}</math></b>		
1.0 $\mu$ F	CV105X5R105K25AT	AVX/Kyocera
<b>Minimum <math>C_{IN}</math></b>		
10.0 $\mu$ F	GRM21BR71A106KE51L	Murata
<b>Schottky Diode</b>		
N/A	RBS520S30	Fairchild Semiconductor
N/A	RB520S-30	Rohm

Physical Dimensions

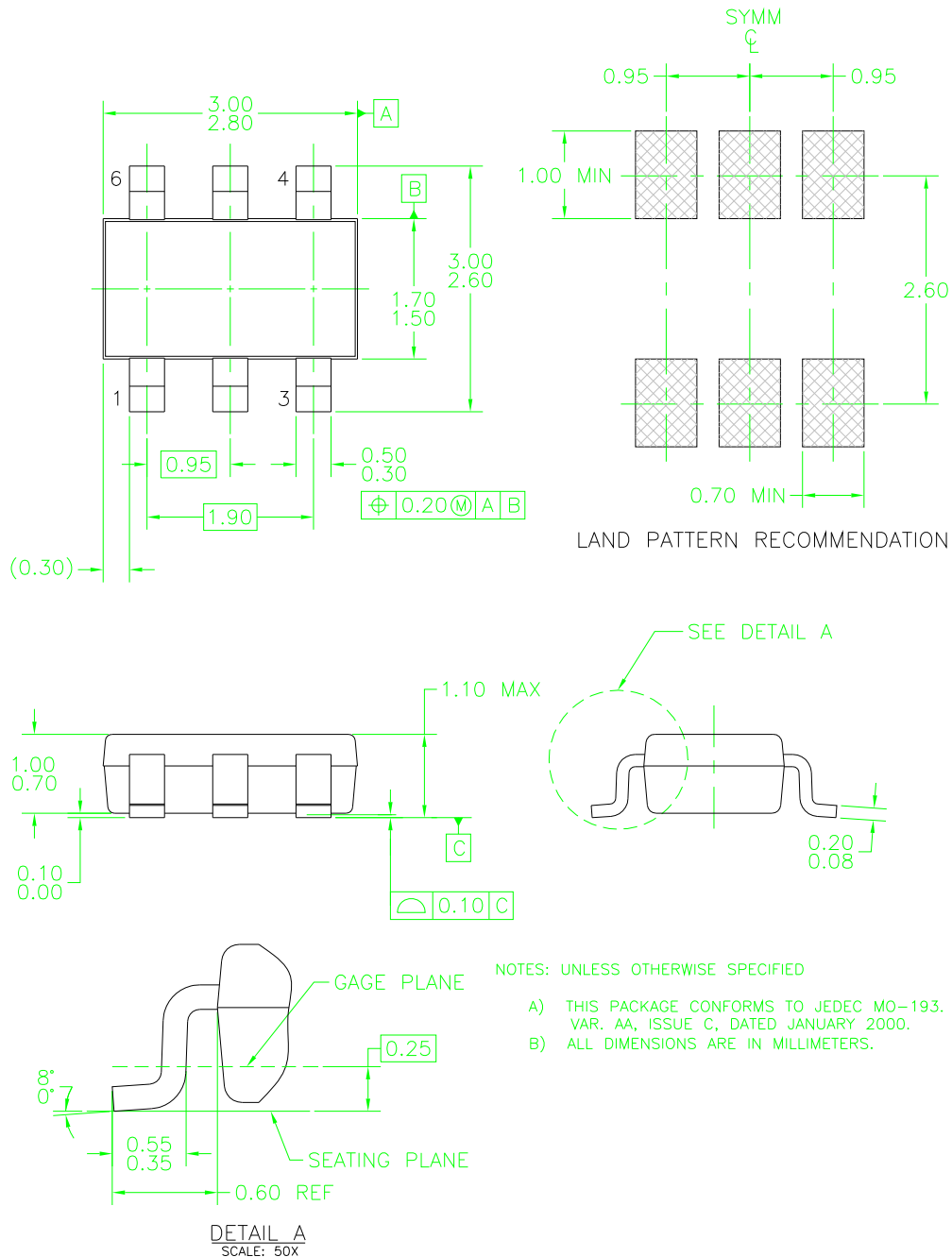

Figure 31. 6-Lead, SuperSOT™-6, JEDEC MO-193, 1.6mm Wide





Package drawings are provided as a service to customers considering Fairchild components. Drawings may change in any manner without notice. Please note the revision and/or date on the drawing and contact a Fairchild Semiconductor representative to verify or obtain the most recent revision. Package specifications do not expand the terms of Fairchild's worldwide terms and conditions, specifically the warranty therein, which covers Fairchild products.

Always visit Fairchild Semiconductor's online packaging area for the most recent package drawings:  
<http://www.fairchildsemi.com/packaging/>



**TRADEMARKS**

The following includes registered and unregistered trademarks and service marks, owned by Fairchild Semiconductor and/or its global subsidiaries, and is not intended to be an exhaustive list of all such trademarks.

- |  |  |  |   |
|--|--|--|---|
| 2Cool™   | FPS™   | PDP SPM™   | The Power Franchise®  |
| AccuPower™   | F-PFST™  | Power-SPM™   | <b>the power franchise</b>  |
| Auto-SPM™  | FRFET®   | PowerTrench®   | TinyBoost™  |
| AX-CAPT™*  | Global Power Resource™                         | PowerXST™  | TinyBuck™   |
| BitSiC®  | Green FPS™                                     | Programmable Active Droop™   | TinyCalc™   |
| Build it Now™  | Green FPS™ e-Series™                           | QFET®  | TinyLogic®  |
| CorePLUS™  | Gmax™  | QST™   | TINYOPTO™   |
| CorePOWER™   | GTOT™  | Quiet Series™  | TinyPower™  |
| CROSSVOLT™   | IntelliMAX™                                    | RapidConfigure™  | TinyPWM™  |
| CTL™   | ISOPLANAR™                                     |  ™                | TinyWire™   |
| Current Transfer Logic™  | Making Small Speakers Sound Louder and Better™ | Saving our world, 1mW/W/KW at a time™  | TranSiC®  |
| DEUXPEED®  | MegaBuck™                                      | SignalWise™  | TriFault Detect™  |
| Dual Cool™   | MICROCOUPLER™                                  | SmartMax™  | TRUECURRENT®*   |
| EcoSPARK®  | MicroFET™                                      | SMART START™   | µSerDes™  |
| EfficientMax™  | MicroPak™                                      | SPM®   |  |
| ESBC™  | MicroPak2™                                     | STEALTH™   | UHC®  |
|  Fairchild® | MillerDrive™                                   | SuperFET®  | Ultra FRFET™  |
| Fairchild Semiconductor®   | MotionMax™                                     | SuperSOT™-3  | UniFET™   |
| FACT Quiet Series™   | Motion-SPM™                                    | SuperSOT™-6  | Vcx™  |
| FACT®  | mWSaver™                                       | SuperSOT™-8  | VisualMax™  |
| FAST®  | OptoHit™                                       | SupreMOS®  | VoltagePlus™  |
| FastvCore™   | OPTOLOGIC®                                     | SyncFET™   | XST™  |
| FETBench™  | OPTOPLANAR®                                    | Sync-Lock™   |   |
| FlashWriter®*  |  |  SYSTEM GENERAL®* |   |

\* Trademarks of System General Corporation, used under license by Fairchild Semiconductor.

**DISCLAIMER**

FAIRCHILD SEMICONDUCTOR RESERVES THE RIGHT TO MAKE CHANGES WITHOUT FURTHER NOTICE TO ANY PRODUCTS HEREIN TO IMPROVE RELIABILITY, FUNCTION, OR DESIGN. FAIRCHILD DOES NOT ASSUME ANY LIABILITY ARISING OUT OF THE APPLICATION OR USE OF ANY PRODUCT OR CIRCUIT DESCRIBED HEREIN; NEITHER DOES IT CONVEY ANY LICENSE UNDER ITS PATENT RIGHTS, NOR THE RIGHTS OF OTHERS. THESE SPECIFICATIONS DO NOT EXPAND THE TERMS OF FAIRCHILD'S WORLDWIDE TERMS AND CONDITIONS, SPECIFICALLY THE WARRANTY THEREIN, WHICH COVERS THESE PRODUCTS.

**LIFE SUPPORT POLICY**

FAIRCHILD'S PRODUCTS ARE NOT AUTHORIZED FOR USE AS CRITICAL COMPONENTS IN LIFE SUPPORT DEVICES OR SYSTEMS WITHOUT THE EXPRESS WRITTEN APPROVAL OF FAIRCHILD SEMICONDUCTOR CORPORATION.

As used herein:

- Life support devices or systems are devices or systems which, (a) are intended for surgical implant into the body or (b) support or sustain life, and (c) whose failure to perform when properly used in accordance with instructions for use provided in the labeling, can be reasonably expected to result in a significant injury of the user.
- A critical component in any component of a life support device, or system whose failure to perform can be reasonably expected to cause the failure of the life support device or system, or to affect its safety or effectiveness.

**ANTI-COUNTERFEITING POLICY**

Fairchild Semiconductor Corporation's Anti-Counterfeiting Policy. Fairchild's Anti-Counterfeiting Policy is also stated on our external website, [www.fairchildsemi.com](http://www.fairchildsemi.com), under Sales Support.

Counterfeiting of semiconductor parts is a growing problem in the industry. All manufacturers of semiconductor products are experiencing counterfeiting of their parts. Customers who inadvertently purchase counterfeit parts experience many problems such as loss of brand reputation, substandard performance, failed applications, and increased cost of production and manufacturing delays. Fairchild is taking strong measures to protect ourselves and our customers from the proliferation of counterfeit parts. Fairchild strongly encourages customers to purchase Fairchild parts either directly from Fairchild or from Authorized Fairchild Distributors who are listed by country on our web page cited above. Products customers buy either from Fairchild directly or from Authorized Fairchild Distributors are genuine parts, have full traceability, meet Fairchild's quality standards for handling and storage and provide access to Fairchild's full range of up-to-date technical and product information. Fairchild and our Authorized Distributors will stand behind all warranties and will appropriately address any warranty issues that may arise. Fairchild will not provide any warranty coverage or other assistance for parts bought from Unauthorized Sources. Fairchild is committed to combat this global problem and encourage our customers to do their part in stopping this practice by buying direct or from authorized distributors.

**PRODUCT STATUS DEFINITIONS**

**Definition of Terms**

Datasheet Identification	Product Status	Definition
Advance Information	Formative / In Design	Datasheet contains the design specifications for product development. Specifications may change in any manner without notice.
Preliminary	First Production	Datasheet contains preliminary data; supplementary data will be published at a later date. Fairchild Semiconductor reserves the right to make changes at any time without notice to improve design.
No Identification Needed	Full Production	Datasheet contains final specifications. Fairchild Semiconductor reserves the right to make changes at any time without notice to improve the design.
Obsolete	Not In Production	Datasheet contains specifications on a product that is discontinued by Fairchild Semiconductor. The datasheet is for reference information only.

Rev. I57