

MC74AC151, MC74ACT151

1-of-8 Decoder/Demultiplexer

The MC74AC151/74ACT151 is a high-speed 8-input digital multiplexer. It provides, in one package, the ability to select one line of data from up to eight sources. The MC74AC151/74ACT151 can be used as a universal function generator to generate any logic function of four variables. Both true and complementary outputs are provided.

- Outputs Source/Sink 24 mA
- 'ACT151 Has TTL Compatible Inputs

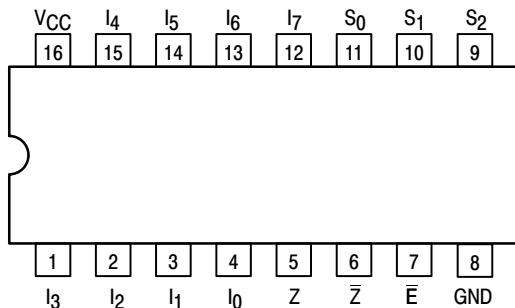

Figure 1. Pinout: 16-Lead Packages Conductors (Top View)

PIN ASSIGNMENT

PIN	FUNCTION
I ₀ –I ₇	Data Inputs
S ₀ –S ₂	Select Inputs
\bar{E}	Enable Input
Z	Data Output
\bar{Z}	Inverted Data Output

TRUTH TABLE

Inputs				Outputs	
\bar{E}	S ₂	S ₁	S ₀	\bar{Z}	Z
H	X	X	X	H	L
L	L	L	L	I ₀	I ₀
L	L	L	H	I ₁	I ₁
L	L	H	L	I ₂	I ₂
L	L	H	H	I ₃	I ₃
L	H	L	L	I ₄	I ₄
L	H	L	H	I ₅	I ₅
L	H	H	L	I ₆	I ₆
L	H	H	H	I ₇	I ₇

H = HIGH Voltage Level
L = LOW Voltage Level
X = Immaterial



ON Semiconductor™

<http://onsemi.com>

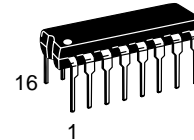

DIP-16
N SUFFIX
CASE 648

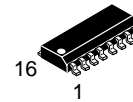

SO-16
D SUFFIX
CASE 751B



TSSOP-16
DT SUFFIX
CASE 948F

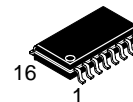

EIAJ-16
M SUFFIX
CASE 966

ORDERING INFORMATION

Device	Package	Shipping
MC74AC151N	PDIP-16	25 Units/Rail
MC74ACT151N	PDIP-16	25 Units/Rail
MC74AC151D	SOIC-16	48 Units/Rail
MC74ACT151D	SOIC-16	48 Units/Rail
MC74AC151DR2	SOIC-16	2500 Tape & Reel
MC74ACT151DR2	SOIC-16	2500 Tape & Reel
MC74AC151DT	TSSOP-16	96 Units/Rail
MC74ACT151DT	TSSOP-16	96 Units/Rail
MC74AC151DTR2	TSSOP-16	2500 Tape & Reel
MC74ACT151DTR2	TSSOP-16	2500 Tape & Reel
MC74AC151M	EIAJ-16	50 Units/Rail
MC74ACT151M	EIAJ-16	50 Units/Rail

DEVICE MARKING INFORMATION

See general marking information in the device marking section on page 140 of this data sheet.

MC74AC151, MC74ACT151

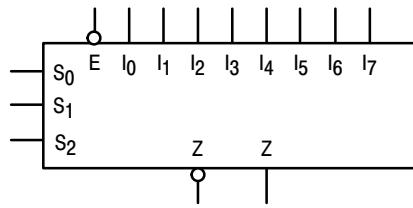

Figure 2. Logic Symbol

FUNCTIONAL DESCRIPTION

The MC74AC151/74ACT151 is a logic implementation of a single pole, 8-position switch with the switch position controlled by the state of three Select inputs, S_0 , S_1 , S_2 . Both true and complementary outputs are provided. The Enable input (\bar{E}) is active LOW. When it is not activated, the complementary output is HIGH and the true output is LOW regardless of all other inputs. The logic function provided at the output is:

$$Z = \bar{E} \cdot (I_0 \cdot \bar{S}_0 \cdot \bar{S}_1 \cdot \bar{S}_2 + I_1 \cdot S_0 \cdot \bar{S}_1 \cdot \bar{S}_2 + I_2 \cdot \bar{S}_0 \cdot S_1 \cdot \bar{S}_2 + I_3 \cdot S_0 \cdot S_1 \cdot \bar{S}_2 + I_4 \cdot \bar{S}_0 \cdot \bar{S}_1 \cdot S_2 + I_5 \cdot S_0 \cdot \bar{S}_1 \cdot S_2 + I_6 \cdot \bar{S}_0 \cdot S_1 \cdot S_2 + I_7 \cdot S_0 \cdot S_1 \cdot S_2)$$

The MC74AC151/74ACT151 provides the ability, in one package, to select from eight sources of data or control information. By proper manipulation of the inputs, the MC74AC151/74ACT151 can provide any logic function of four variables and its complement.

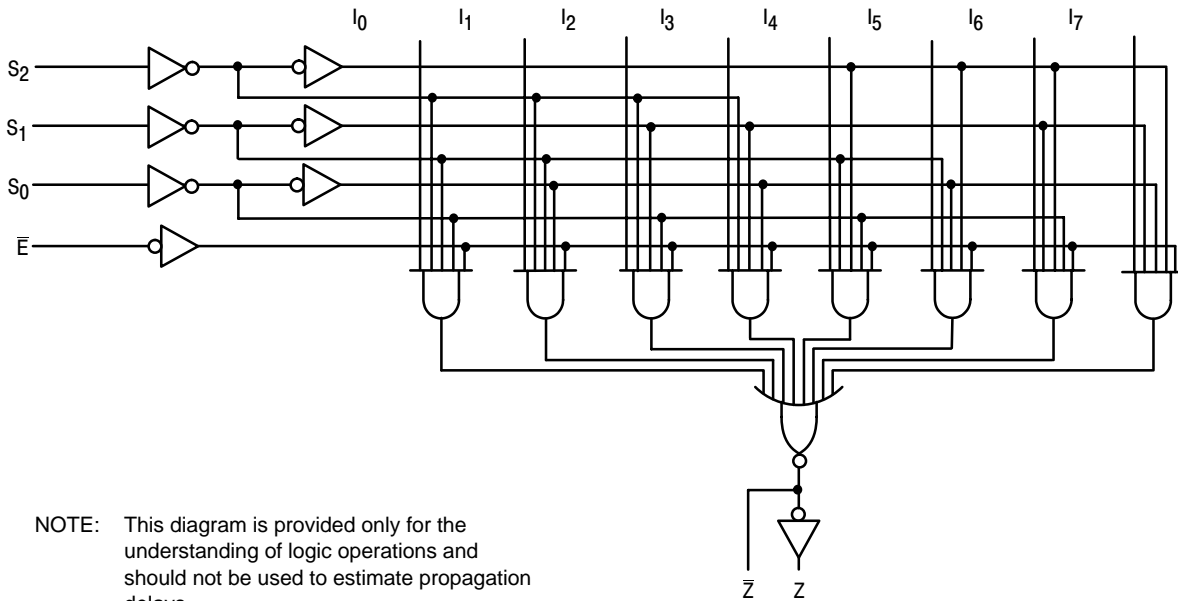

NOTE: This diagram is provided only for the understanding of logic operations and should not be used to estimate propagation delays.

Figure 3. Logic Diagram

MC74AC151, MC74ACT151

MAXIMUM RATINGS*

Symbol	Parameter	Value	Unit
V _{CC}	DC Supply Voltage (Referenced to GND)	-0.5 to +7.0	V
V _{IN}	DC Input Voltage (Referenced to GND)	-0.5 to V _{CC} +0.5	V
V _{OUT}	DC Output Voltage (Referenced to GND)	-0.5 to V _{CC} +0.5	V
I _{IN}	DC Input Current, per Pin	±20	mA
I _{OUT}	DC Output Sink/Source Current, per Pin	±50	mA
I _{CC}	DC V _{CC} or GND Current per Output Pin	±50	mA
T _{stg}	Storage Temperature	-65 to +150	°C

*Maximum Ratings are those values beyond which damage to the device may occur. Functional operation should be restricted to the Recommended Operating Conditions.

RECOMMENDED OPERATING CONDITIONS

Symbol	Parameter	Min	Typ	Max	Unit	
V _{CC}	Supply Voltage	'AC	2.0	5.0	6.0	V
		'ACT	4.5	5.0	5.5	
V _{IN} , V _{OUT}	DC Input Voltage, Output Voltage (Ref. to GND)	0	-	V _{CC}	V	
t _r , t _f	Input Rise and Fall Time (Note 1) 'AC Devices except Schmitt Inputs	V _{CC} @ 3.0 V	-	150	-	ns/V
		V _{CC} @ 4.5 V	-	40	-	
		V _{CC} @ 5.5 V	-	25	-	
t _r , t _f	Input Rise and Fall Time (Note 2) 'ACT Devices except Schmitt Inputs	V _{CC} @ 4.5 V	-	10	-	ns/V
		V _{CC} @ 5.5 V	-	8.0	-	
T _J	Junction Temperature (PDIP)	-	-	140	°C	
T _A	Operating Ambient Temperature Range	-40	25	85	°C	
I _{OH}	Output Current – High	-	-	-24	mA	
I _{OL}	Output Current – Low	-	-	24	mA	

1. V_{IN} from 30% to 70% V_{CC}; see individual Data Sheets for devices that differ from the typical input rise and fall times.
2. V_{IN} from 0.8 V to 2.0 V; see individual Data Sheets for devices that differ from the typical input rise and fall times.

MC74AC151, MC74ACT151

DC CHARACTERISTICS

Symbol	Parameter	V _{CC} (V)	74AC		74AC	Unit	Conditions
			T _A = +25°C		T _A = -40°C to +85°C		
			Typ	Guaranteed Limits			
V _{IH}	Minimum High Level Input Voltage	3.0	1.5	2.1	2.1	V	V _{OUT} = 0.1 V or V _{CC} - 0.1 V
		4.5	2.25	3.15	3.15		
		5.5	2.75	3.85	3.85		
V _{IL}	Maximum Low Level Input Voltage	3.0	1.5	0.9	0.9	V	V _{OUT} = 0.1 V or V _{CC} - 0.1 V
		4.5	2.25	1.35	1.35		
		5.5	2.75	1.65	1.65		
V _{OH}	Minimum High Level Output Voltage	3.0	2.99	2.9	2.9	V	I _{OUT} = -50 μA
		4.5	4.49	4.4	4.4		
		5.5	5.49	5.4	5.4		
		3.0	-	2.56	2.46	V	*V _{IN} = V _{IL} or V _{IH} -12 mA I _{OH} -24 mA -24 mA
		4.5	-	3.86	3.76		
		5.5	-	4.86	4.76		
V _{OL}	Maximum Low Level Output Voltage	3.0	0.002	0.1	0.1	V	I _{OUT} = 50 μA
		4.5	0.001	0.1	0.1		
		5.5	0.001	0.1	0.1		
		3.0	-	0.36	0.44	V	*V _{IN} = V _{IL} or V _{IH} 12 mA I _{OL} 24 mA 24 mA
		4.5	-	0.36	0.44		
		5.5	-	0.36	0.44		
I _{IN}	Maximum Input Leakage Current	5.5	-	±0.1	±1.0	μA	V _I = V _{CC} , GND
I _{OLD}	†Minimum Dynamic Output Current	5.5	-	-	75	mA	V _{OLD} = 1.65 V Max
I _{OHD}		5.5	-	-	-75	mA	V _{OHD} = 3.85 V Min
I _{CC}	Maximum Quiescent Supply Current	5.5	-	8.0	80	μA	V _{IN} = V _{CC} or GND

*All outputs loaded; thresholds on input associated with output under test.

†Maximum test duration 2.0 ms, one output loaded at a time.

NOTE: I_{IN} and I_{CC} @ 3.0 V are guaranteed to be less than or equal to the respective limit @ 5.5 V V_{CC}.

MC74AC151, MC74ACT151

AC CHARACTERISTICS (For Figures and Waveforms – See Section 3 of the ON Semiconductor FACT Data Book, DL138/D)

Symbol	Parameter	V _{CC} * (V)	74AC			74AC		Unit	Fig. No.
			T _A = +25°C C _L = 50 pF			T _A = -40°C to +85°C C _L = 50 pF			
			Min	Typ	Max	Min	Max		
t _{PLH}	Propagation Delay S _n to Z or \bar{Z}	3.3 5.0	3.0 2.5	11.5 8.5	18.0 13.0	3.0 2.0	20.0 15.0	ns	3-6
t _{PHL}	Propagation Delay S _n to Z or \bar{Z}	3.3 5.0	2.5 2.0	12 8.5	18.0 13.0	2.5 1.5	20.0 15.0	ns	3-6
t _{PLH}	Propagation Delay \bar{E} to Z or \bar{Z}	3.3 5.0	2.5 2.0	8.0 6.0	13.0 10.0	2.0 1.5	14.0 11.0	ns	3-6
t _{PHL}	Propagation Delay E to Z or \bar{Z}	3.3 5.0	1.5 1.5	8.5 6.5	13.0 10.0	1.5 1.5	14.0 11.0	ns	3-6
t _{PLH}	Propagation Delay I _n to Z or \bar{Z}	3.3 5.0	2.5 1.5	9.5 7.0	14.0 10.5	2.0 1.5	15.5 11.0	ns	3-5
t _{PHL}	Propagation Delay I _n to Z or \bar{Z}	3.3 5.0	2.5 1.5	9.5 7.0	15.0 11.0	2.0 1.5	16.0 12.0	ns	3-5

*Voltage Range 3.3 V is 3.3 V ± 0.3 V

*Voltage Range 5.0 V is 5.0 V ± 0.5 V

DC CHARACTERISTICS

Symbol	Parameter	V _{CC} (V)	74ACT		74ACT		Unit	Conditions
			T _A = +25°C		T _A = -40°C to +85°C			
			Typ	Guaranteed Limits				
V _{IH}	Minimum High Level Input Voltage	4.5	1.5	2.0	2.0	V	V _{OUT} = 0.1 V or V _{CC} - 0.1 V	
		5.5	1.5	2.0	2.0			
V _{IL}	Maximum Low Level Input Voltage	4.5	1.5	0.8	0.8	V	V _{OUT} = 0.1 V or V _{CC} - 0.1 V	
		5.5	1.5	0.8	0.8			
V _{OH}	Minimum High Level Output Voltage	4.5	4.49	4.4	4.4	V	I _{OUT} = -50 μA	
		5.5	5.49	5.4	5.4			
		4.5	-	3.86	3.76	V	*V _{IN} = V _{IL} or V _{IH} I _{OH} = -24 mA	
		5.5	-	4.86	4.76			
V _{OL}	Maximum Low Level Output Voltage	4.5	0.001	0.1	0.1	V	I _{OUT} = 50 μA	
		5.5	0.001	0.1	0.1			
		4.5	-	0.36	0.44	V	*V _{IN} = V _{IL} or V _{IH} I _{OL} = 24 mA	
		5.5	-	0.36	0.44			
I _{IN}	Maximum Input Leakage Current	5.5	-	±0.1	±1.0	μA	V _I = V _{CC} , GND	
ΔI _{CC} T	Additional Max. I _{CC} /Input	5.5	0.6	-	1.5	mA	V _I = V _{CC} - 2.1 V	
I _{OLD}	†Minimum Dynamic Output Current	5.5	-	-	75	mA	V _{OLD} = 1.65 V Max	
I _{OHD}		5.5	-	-	-75	mA	V _{OHD} = 3.85 V Min	
I _{CC}	Maximum Quiescent Supply Current	5.5	-	8.0	80	μA	V _{IN} = V _{CC} or GND	

*All outputs loaded; thresholds on input associated with output under test.

†Maximum test duration 2.0 ms, one output loaded at a time.

MC74AC151, MC74ACT151

AC CHARACTERISTICS (For Figures and Waveforms – See Section 3 of the ON Semiconductor FACT Data Book, DL138/D)

Symbol	Parameter	V _{CC} * (V)	74ACT			74ACT		Unit	Fig. No.
			T _A = +25°C C _L = 50 pF			T _A = -40°C to +85°C C _L = 50 pF			
			Min	Typ	Max	Min	Max		
t _{PLH}	Propagation Delay S _n to Z	5.0	3.5	–	15.5	3.0	17.0	ns	3–6
t _{PHL}	Propagation Delay S _n to Z	5.0	3.5	–	15.5	3.0	16.5	ns	3–6
t _{PLH}	Propagation Delay S _n to \bar{Z}	5.0	3.5	–	15	3.0	16.5	ns	3–6
t _{PHL}	Propagation Delay S _n to \bar{Z}	5.0	4.0	–	16.5	3.5	18.5	ns	3–6
t _{PLH}	Propagation Delay \bar{E} to Z	5.0	2.5	–	9.5	2.5	10.0	ns	3–6
t _{PHL}	Propagation Delay \bar{E} to Z	5.0	2.5	–	9.0	2.5	10.0	ns	3–6
t _{PLH}	Propagation Delay \bar{E} to \bar{Z}	5.0	2.5	–	8.5	2.5	9.5	ns	3–6
t _{PHL}	Propagation Delay \bar{E} to \bar{Z}	5.0	3.0	–	10.0	2.5	10.5	ns	3–6
t _{PLH}	Propagation Delay I _n to Z	5.0	3.5	–	11.5	3.0	12.5	ns	3–6
t _{PHL}	Propagation Delay I _n to Z	5.0	3.5	–	12.0	3.0	13.5	ns	3–6
t _{PLH}	Propagation Delay I _n to \bar{Z}	5.0	3.5	–	12.0	3.0	13.0	ns	3–6
t _{PHL}	Propagation Delay I _n to \bar{Z}	5.0	4.0	–	12.5	3.0	14.0	ns	3–6

*Voltage Range 5.0 V is 5.0 V ± 0.5 V

CAPACITANCE

Symbol	Parameter	Value Typ	Unit	Test Conditions
C _{IN}	Input Capacitance	4.5	pF	V _{CC} = 5.0 V
C _{PD}	Power Dissipation Capacitance	70	pF	V _{CC} = 5.0 V

MC74AC151, MC74ACT151

MARKING DIAGRAMS

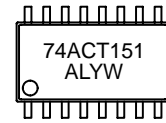
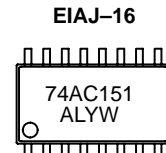
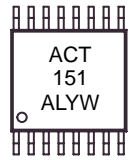
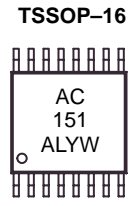
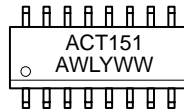
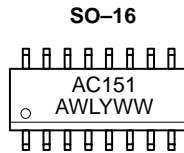
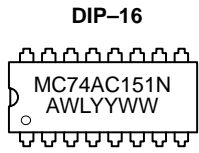

A = Assembly Location
WL, L = Wafer Lot
YY, Y = Year
WW, W = Work Week