

CS3524A

Voltage Mode PWM Control Circuit with 200 mA Output Drivers

The CS3524A PWM control circuit retains the same versatile architecture of the industry standard CS3524 (SG3524) while adding substantial improvements.

The CS3524 is pin-compatible with “non-A” versions, and in most applications can be directly interchanged. The CS3524A, however, eliminates many of the design restrictions which had previously required additional external circuitry.

The CS3524A includes a precision 5.0 V reference trimmed to $\pm 1\%$ accuracy (eliminating the need for potentiometer adjustments), an error amplifier with an output voltage swing extending to 5.0 V, and a current sense amplifier useful in either the ground or power supply output lines. The uncommitted 60 V, 200 mA NPN output pair greatly enhances the output drive capability.

The CS3524A features an undervoltage lockout circuit which disables all internal circuitry (except the reference) until the input voltage has risen to 8.0 V. This holds standby current low until turn-on, and greatly simplifies the design of low power, off-line supplies. The turn-on circuit has approximately 600 mV of hysteresis for jitter free activation.

Other improvements include a PWM latch that insures freedom from multiple pulsing within a period, even in noisy environments; logic to eliminate double pulsing on a single output, a 200 ns external shutdown capability, and automatic thermal protection from excessive chip temperature. The oscillator circuit is usable to 500 kHz and is easier to synchronize with an external clock pulse.

Features

- Precision Reference Internally Trimmed to $\pm 1\%$
- Current Limit
- Undervoltage Lockout
- Start-Up Supply Current < 4.0 mA
- Output to 200 mA
- 60 V Output Capability
- Wide Common-Mode Input Range for Error and Current Limit Amplifiers
- PWM Latch Insures Single Pulse per Period
- Double Pulse Suppression
- 200 ns Shutdown
- Guaranteed Frequency
- Thermal Shutdown



ON Semiconductor™

<http://onsemi.com>

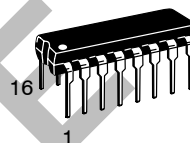

DIP-16
N SUFFIX
CASE 648

MARKING DIAGRAMS

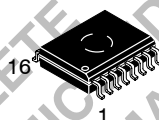
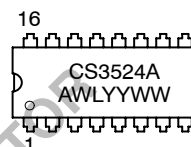

SO-16L
DW SUFFIX
CASE 751G

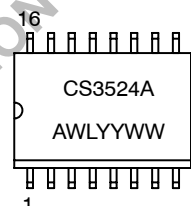

A = Assembly Location
WL, L = Wafer Lot
YY, Y = Year
WW, W = Work Week

PIN CONNECTIONS

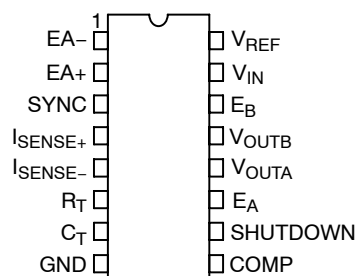

ORDERING INFORMATION

Device	Package	Shipping
CS3524AGN16	DIP-16	25 Units/Rail
CS3524AGDW16	SO-16L	46 Units/Rail
CS3524AGDWR16	SO-16L	1000 Tape & Reel

CS3524A

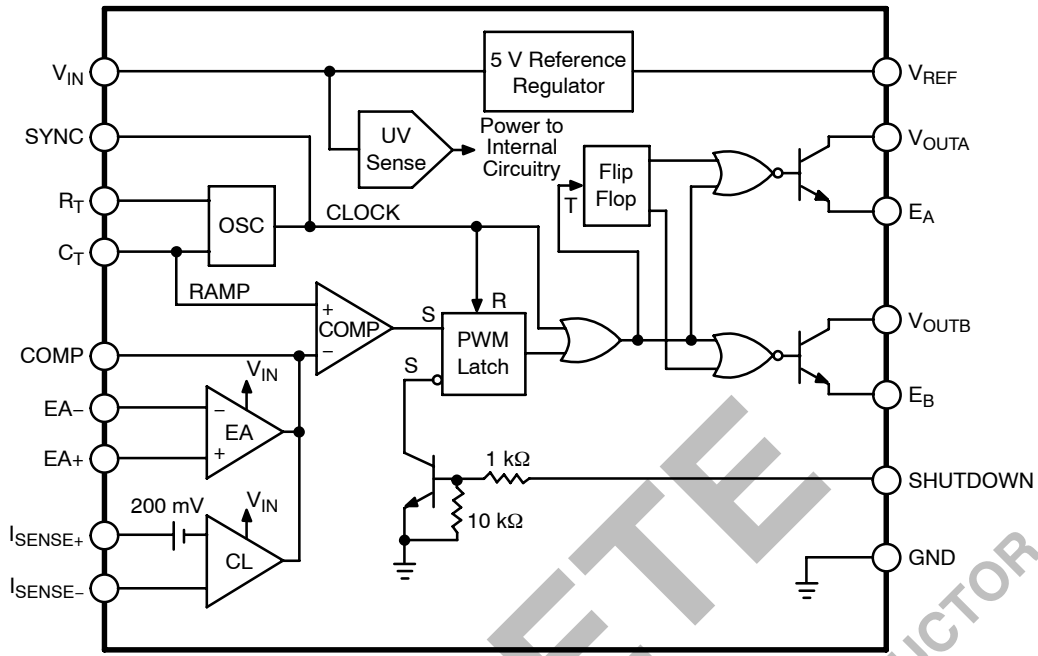

Figure 1. Block Diagram

ABSOLUTE MAXIMUM RATINGS*

Rating	Value	Unit
Supply Voltage (V_{IN})	40	V
Collector Supply Voltage (V_{CC})	60	V
Output Current (Each Output)	200	mA
Reference Output Current	50	mA
Oscillator Charging Current	5.0	mA
Power Dissipation at $T_A = 25^\circ\text{C}$	1000	mW
Power Dissipation at $T_J = +25^\circ\text{C}$ Derate for Case Temperature above $+25^\circ\text{C}$	2000 16	mW mW/ $^\circ\text{C}$
Storage Temperature Range	-65 to +150	$^\circ\text{C}$
Lead Temperature Soldering	Wave Solder (through hole styles only) Note 1 Reflow (SMD styles only) Note 2	260 peak 230 peak $^\circ\text{C}$ $^\circ\text{C}$

1. 10 seconds max.
2. 60 seconds max above 183°C

*The maximum package power dissipation must be observed.

CS3524A

ELECTRICAL CHARACTERISTICS (0°C ≤ T_A ≤ +70°C, V_{IN} = V_{CC} = 20 V; unless otherwise specified.)

Characteristic	Test Conditions	Min	Typ	Max	Unit
----------------	-----------------	-----	-----	-----	------

Turn-On Characteristics

Input Voltage	Operating Range after Turn-On	8.0	–	40	V
Turn-On Threshold	–	5.5	7.5	8.5	V
Turn-On Current	V _{IN} Turn-On – 100 mV	–	2.5	4.0	mA
Operating Current	V _{IN} = 8.0 to 40 V	–	5.0	10	mA
Turn-On Hysteresis (Note 3)	–	–	0.6	–	V

Reference Section

Output Voltage	T _A = 25°C	4.9	5.0	5.2	V
Line Regulation	V _{IN} = 10 to 40 V	–	10	30	mV
Load Regulation	I _L = 0 to 20 mA	–	20	50	mA
Temperature Stability (Note 3)	Over Operating Range	–	20	50	mV
Short Circuit Current	V _{REF} = 0, T _A = 25°C	–	80	100	mA
Output Noise Voltage (Note 3)	10 Hz ≤ f ≤ 10 kHz, T _A = 25°C	–	40	–	μV _{RMS}
Long Term Stability (Note 3)	T _A = 125°C, 1000 Hrs.	–	20	50	mV

Oscillator Section

R_T = 2700 Ω, C_T = 0.01 μF; unless otherwise specified

Initial Accuracy	T _A = 25°C	39	43	47	kHz
Temperature Stability (Note 3)	Over Operating Temperature Range	–	1.0	2.0	%
Minimum Frequency	R _T = 150 kΩ, C _T = 0.1 μF	–	–	120	Hz
Maximum Frequency	R _T = 2.0 kΩ, C _T = 470 pF	500	–	–	kHz
Output Amplitude (Note 3)	T _A = 25°C	–	3.5	–	V
Output Pulse Width (Note 3)	T _A = 25°C	–	0.5	–	μs
Ramp Peak	–	3.3	3.5	3.7	V
Ramp Valley	–	0.7	0.9	1.0	V

Error Amplifier Section

V_{CM} = 2.5 V; unless otherwise specified

Input Offset Voltage	–	–	2.0	10	mV
Input Bias Current	–	–	1.0	10	μA
Input Offset Current	–	–	0.5	1.0	μA
Common Mode Rejection Ratio	V _{CM} = 1.5 to 5.5 V	60	75	–	dB
Power Supply Rejection Ratio	V _{IN} = 10 to 40 V	50	60	–	dB
Output Swing	Minimum Total Range	0.5	–	5.0	V
Open Loop Voltage Gain	ΔV _{OUT} = 1.0 to 4.0 V, R _L ≥ 10 MΩ	60	80	–	dB
Gain-Bandwidth (Note 3)	T _A = 25°C, A _V = 0 dB	–	3.0	–	MHz

Current Limit Amplifier

V_{SENSE} = V_O; unless otherwise specified

Input Offset Voltage	T _A = 25°C, EA Set for Max. Output	180	200	220	mV
Input Offset Voltage	Over Operating Temperature Range	170	–	230	mV
Input Bias Current	–	–	–1.0	–10	μA
Common Mode Rejection Ratio	V _{SENSE} = 0 to 15 V	50	60	–	dB
Power Supply Rejection Ratio	V _{IN} = 10 to 40 V	50	60	–	dB

3. These parameters are guaranteed by design but not 100% tested in production.

CS3524A

ELECTRICAL CHARACTERISTICS (continued) ($0^{\circ}\text{C} \leq T_A \leq +70^{\circ}\text{C}$, $V_{\text{IN}} = V_{\text{CC}} = 20\text{ V}$; unless otherwise specified.)

Characteristic	Test Conditions	Min	Typ	Max	Unit
Current Limit Amplifier (continued) $V_{\text{SENSE}} = V_{\text{O}}$; unless otherwise specified					
Output Swing	Minimum Total Range	0.5	-	5.0	V
Open Loop Voltage Gain	$\Delta V_{\text{OUT}} = 1.0$ to 4.0 V , $R_L \geq 10\text{ M}\Omega$	70	80	-	dB
Delay Time (Note 4)	$\Delta V_{\text{IN}} = 300\text{ mV}$	-	300	-	ns
Output Section (Each Output)					
Collector Emitter Voltage	$I_C = 100\ \mu\text{A}$	60	80	-	V
Collector Leakage Current	$V_{\text{CE}} = 50\text{ V}$	-	0.1	20	μA
Saturation	$I_C = 20\text{ mA}$	-	0.2	0.4	V
	$I_C = 200\text{ mA}$	-	1.0	2.2	V
Emitter Output Voltage	$I_E = 50\text{ mA}$	17	18	-	V
Rise Time (Note 4)	$T_A = 25^{\circ}\text{C}$, $R = 2.0\text{ k}\Omega$	-	200	-	ns
Fall Time (Note 4)	$T_A = 25^{\circ}\text{C}$, $R = 2.0\text{ k}\Omega$	-	100	-	ns
Comparator Delay (Note 4)	$T_A = 25^{\circ}\text{C}$, V_{COMP} to V_{OUT}	-	300	-	ns
Shutdown Delay (Note 4)	$T_A = 25^{\circ}\text{C}$, V_{SHUT} to V_{OUT}	-	200	-	ns
Shutdown Threshold	$T_A = 25^{\circ}\text{C}$, $R_C = 2.0\text{ k}\Omega$	0.5	0.7	1.0	V
Thermal Shutdown (Note 4)	-	-	165	-	$^{\circ}\text{C}$

4. These parameters are guaranteed by design but not 100% tested in production.

TYPICAL PERFORMANCE CHARACTERISTICS

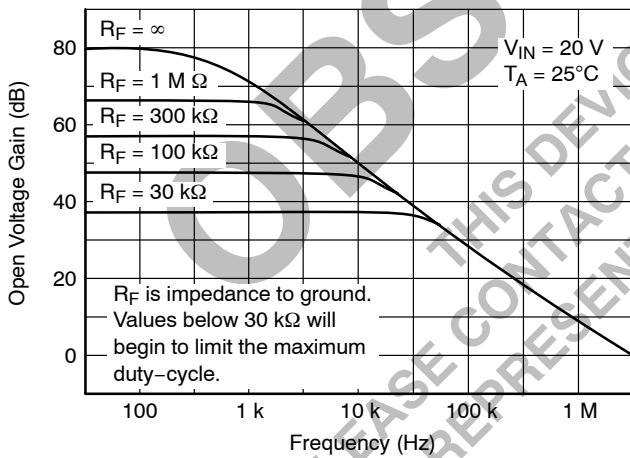

Figure 2. Error Amplifier Voltage Gain vs. Frequency Over R_F

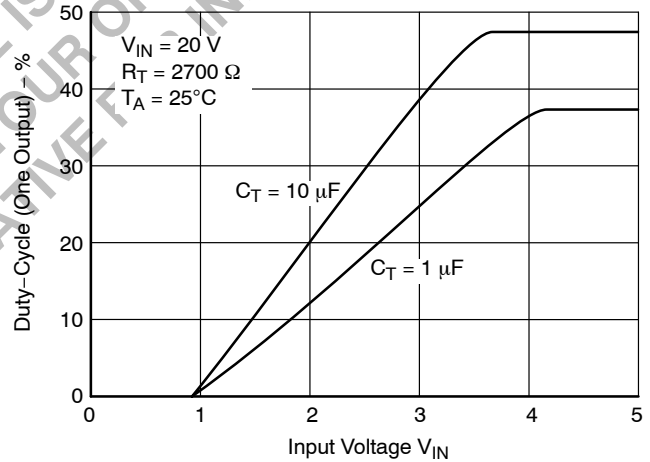

Figure 3. Duty Cycle vs. Input Voltage

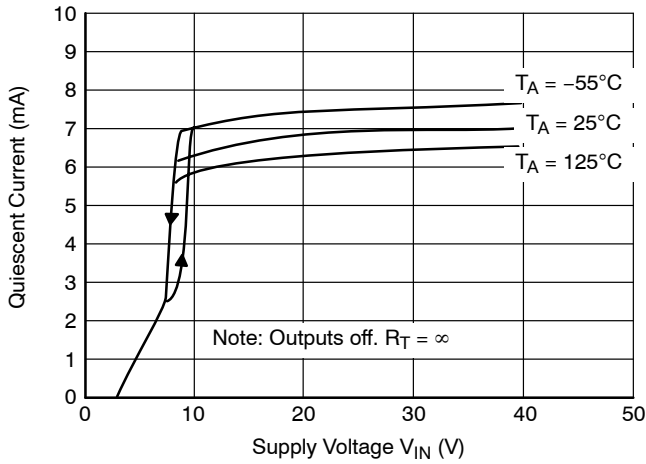

Figure 4. Quiescent Supply Current vs. Supply Voltage Over Temperature

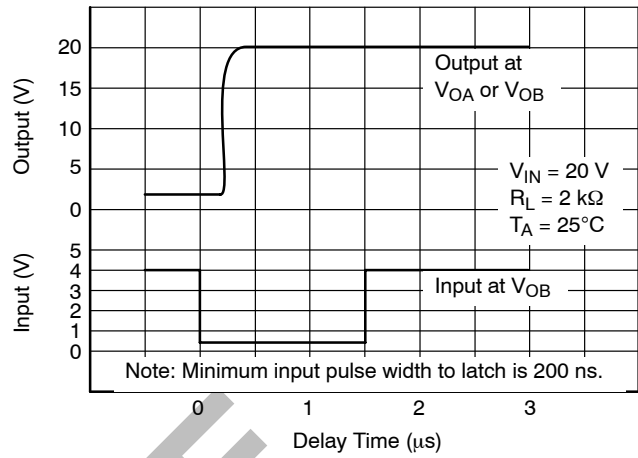

Figure 5. Shutdown Delay from PWM Comparator

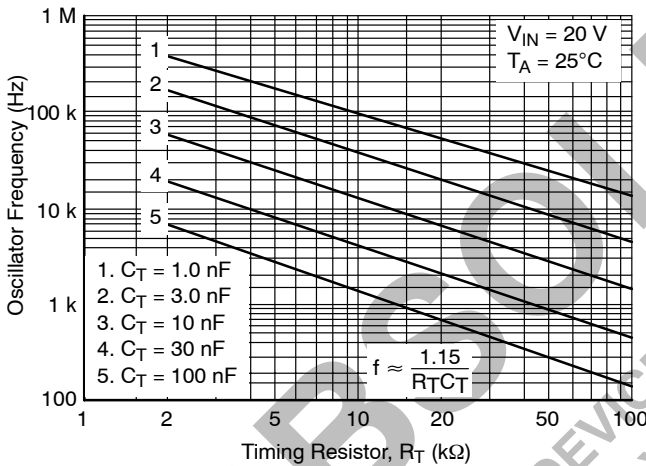

Figure 6. Oscillator Frequency vs. Timing Components Resistor Over Timing Capacitance

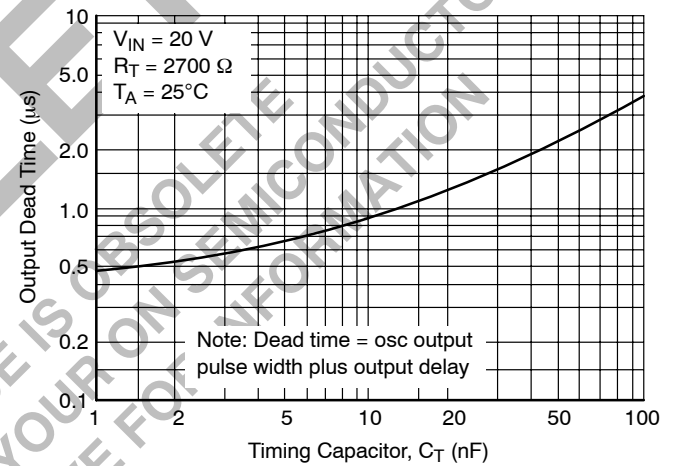

Figure 7. Output Dead Time vs. Timing Capacitor Value

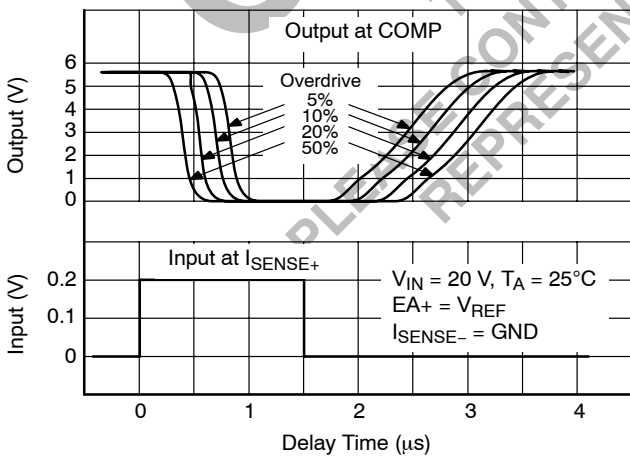

Figure 8. Current Limit Amplifier Delay

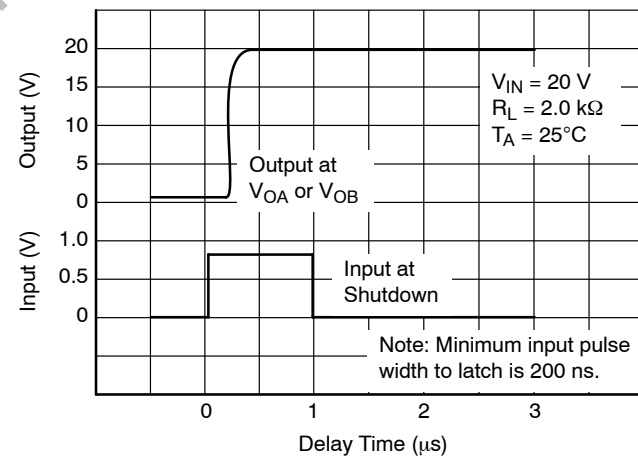

Figure 9. Turn-Off Delay from Shutdown

CS3524A

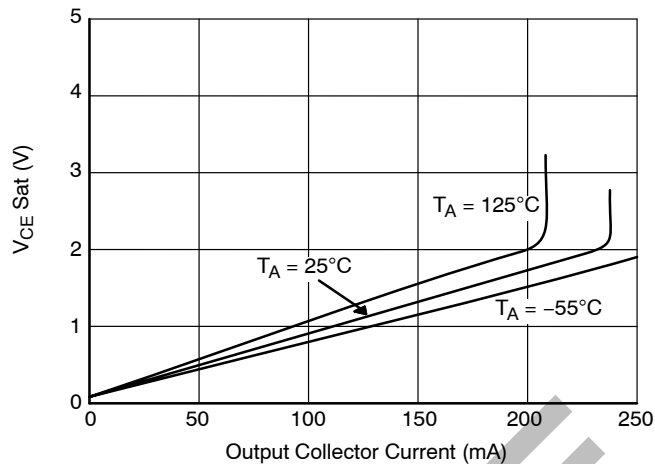

Figure 10. Output Saturation Voltage vs. Output Current Over Temperature

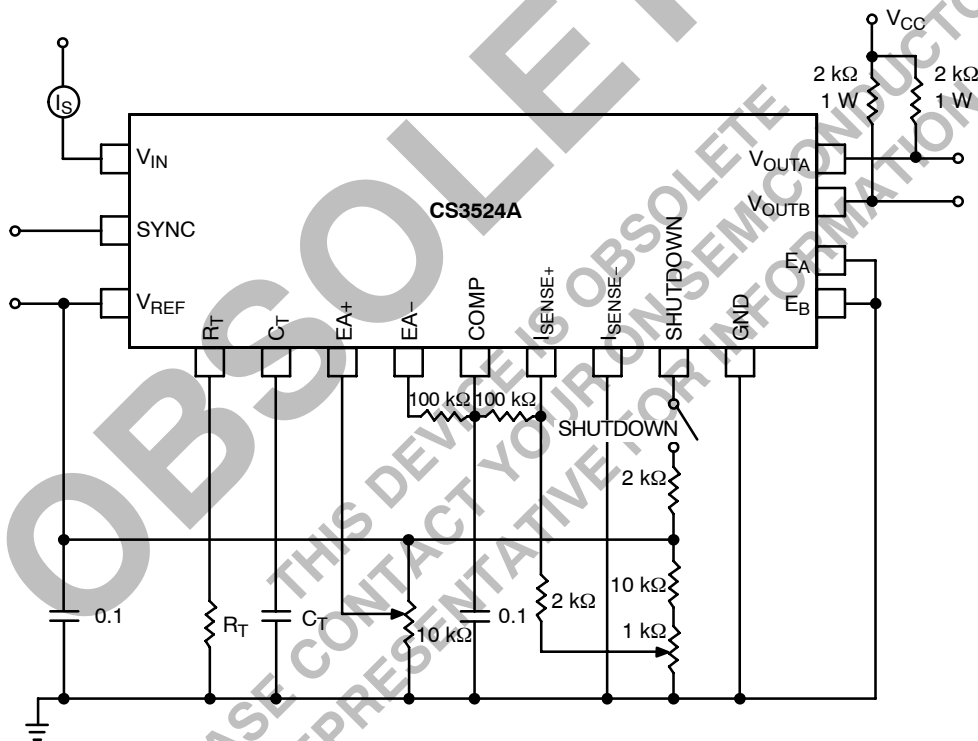

Figure 11. Open Loop Test Circuit

Note: The CS3524A should be able to be tested in any 3524 test circuit with two possible exceptions:

1. The higher gain–bandwidth of the current limit amplifier in the CS3524A may cause oscillations in an uncompensated 3524 test circuit.

2. The effect of the shutdown cannot be seen at the compensation terminal, but must be observed at the outputs.

CS3524A

PACKAGE DIMENSIONS

DIP-16
N SUFFIX
 CASE 648-08
 ISSUE R

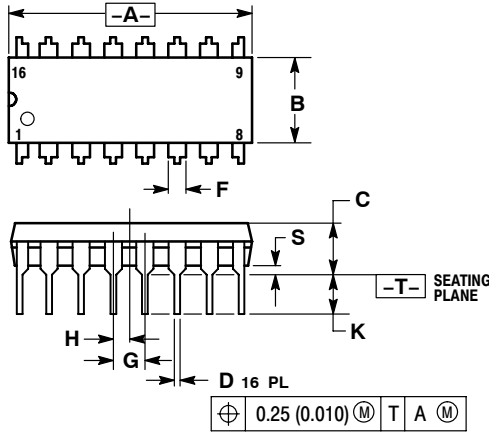

NOTES:

1. DIMENSIONING AND TOLERANCING PER ANSI Y14.5M, 1982.
2. CONTROLLING DIMENSION: INCH.
3. DIMENSION L TO CENTER OF LEADS WHEN FORMED PARALLEL.
4. DIMENSION B DOES NOT INCLUDE MOLD FLASH.
5. ROUNDED CORNERS OPTIONAL.

DIM	INCHES		MILLIMETERS	
	MIN	MAX	MIN	MAX
A	0.740	0.770	18.80	19.55
B	0.250	0.270	6.35	6.85
C	0.145	0.175	3.69	4.44
D	0.015	0.021	0.39	0.53
F	0.040	0.70	1.02	1.77
G	0.100 BSC		2.54 BSC	
H	0.050 BSC		1.27 BSC	
J	0.008	0.015	0.21	0.38
K	0.110	0.130	2.80	3.30
L	0.295	0.305	7.50	7.74
M	0°	10°	0°	10°
S	0.020	0.040	0.51	1.01

SO-16L
DW SUFFIX
 CASE 751G-03
 ISSUE B

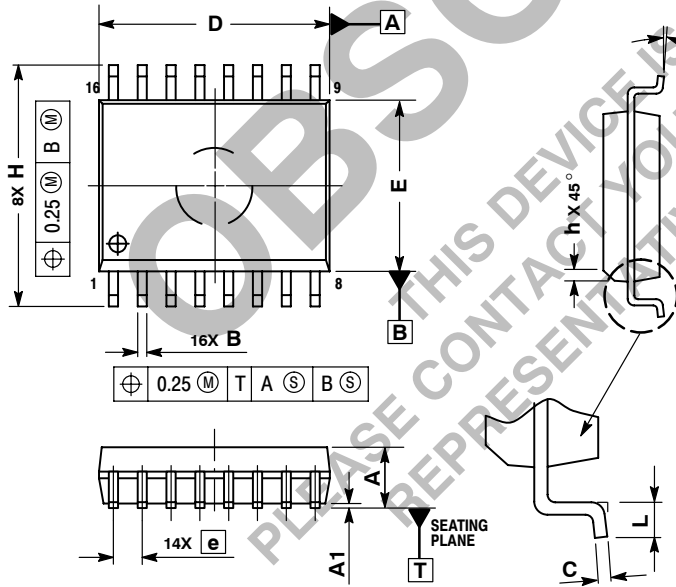

NOTES:

1. DIMENSIONS ARE IN MILLIMETERS.
2. INTERPRET DIMENSIONS AND TOLERANCES PER ASME Y14.5M, 1994.
3. DIMENSIONS D AND E DO NOT INCLUDE MOLD PROTRUSION.
4. MAXIMUM MOLD PROTRUSION 0.15 PER SIDE.
5. DIMENSION B DOES NOT INCLUDE DAMBAR PROTRUSION. ALLOWABLE DAMBAR PROTRUSION SHALL BE 0.13 TOTAL IN EXCESS OF THE B DIMENSION AT MAXIMUM MATERIAL CONDITION.

DIM	MILLIMETERS	
	MIN	MAX
A	2.35	2.65
A1	0.10	0.25
B	0.35	0.49
C	0.23	0.32
D	10.15	10.45
E	7.40	7.60
e	1.27 BSC	
H	10.05	10.55
h	0.25	0.75
L	0.50	0.90
theta	0°	7°

PACKAGE THERMAL DATA

Parameter		DIP-16	SO-16L	Unit
R _{θJC}	Typical	42	23	°C/W
R _{θJA}	Typical	80	105	°C/W

OBSOLETE
 THIS DEVICE IS OBSOLETE
 PLEASE CONTACT YOUR ON SEMICONDUCTOR
 REPRESENTATIVE FOR INFORMATION

ON Semiconductor and  are registered trademarks of Semiconductor Components Industries, LLC (SCILLC). SCILLC reserves the right to make changes without further notice to any products herein. SCILLC makes no warranty, representation or guarantee regarding the suitability of its products for any particular purpose, nor does SCILLC assume any liability arising out of the application or use of any product or circuit, and specifically disclaims any and all liability, including without limitation special, consequential or incidental damages. "Typical" parameters which may be provided in SCILLC data sheets and/or specifications can and do vary in different applications and actual performance may vary over time. All operating parameters, including "Typicals" must be validated for each customer application by customer's technical experts. SCILLC does not convey any license under its patent rights nor the rights of others. SCILLC products are not designed, intended, or authorized for use as components in systems intended for surgical implant into the body, or other applications intended to support or sustain life, or for any other application in which the failure of the SCILLC product could create a situation where personal injury or death may occur. Should Buyer purchase or use SCILLC products for any such unintended or unauthorized application, Buyer shall indemnify and hold SCILLC and its officers, employees, subsidiaries, affiliates, and distributors harmless against all claims, costs, damages, and expenses, and reasonable attorney fees arising out of, directly or indirectly, any claim of personal injury or death associated with such unintended or unauthorized use, even if such claim alleges that SCILLC was negligent regarding the design or manufacture of the part. SCILLC is an Equal Opportunity/Affirmative Action Employer. This literature is subject to all applicable copyright laws and is not for resale in any manner.

PUBLICATION ORDERING INFORMATION

LITERATURE FULFILLMENT:

Literature Distribution Center for ON Semiconductor
 P.O. Box 5163, Denver, Colorado 80217 USA
Phone: 303-675-2175 or 800-344-3860 Toll Free USA/Canada
Fax: 303-675-2176 or 800-344-3867 Toll Free USA/Canada
Email: orderlit@onsemi.com

N. American Technical Support: 800-282-9855 Toll Free
 USA/Canada
Europe, Middle East and Africa Technical Support:
 Phone: 421 33 790 2910
Japan Customer Focus Center
 Phone: 81-3-5773-3850

ON Semiconductor Website: www.onsemi.com

Order Literature: <http://www.onsemi.com/orderlit>

For additional information, please contact your local
 Sales Representative