

FQP3N80C/FQPF3N80C

800V N-Channel MOSFET

General Description

These N-Channel enhancement mode power field effect transistors are produced using Fairchild's proprietary, planar stripe, DMOS technology.

This advanced technology has been especially tailored to minimize on-state resistance, provide superior switching performance, and withstand high energy pulse in the avalanche and commutation mode. These devices are well suited for high efficiency switch mode power supplies.

Features

- 3.0A, 800V, $R_{DS(on)} = 4.8\Omega @ V_{GS} = 10V$
- Low gate charge (typical 13 nC)
- Low C_{rss} (typical 5.5 pF)
- Fast switching
- 100% avalanche tested
- Improved dv/dt capability

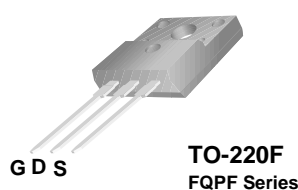
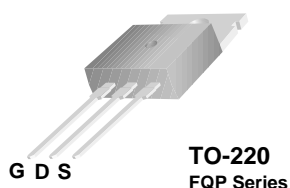

Absolute Maximum Ratings $T_C = 25^\circ\text{C}$ unless otherwise noted

Symbol	Parameter	FQP3N80C	FQPF3N80C	Units
V_{DSS}	Drain-Source Voltage	800		V
I_D	Drain Current - Continuous ($T_C = 25^\circ\text{C}$) - Continuous ($T_C = 100^\circ\text{C}$)	3	3 *	A
		1.9	1.9 *	A
I_{DM}	Drain Current - Pulsed (Note 1)	12	12 *	A
V_{GSS}	Gate-Source Voltage	± 30		V
E_{AS}	Single Pulsed Avalanche Energy (Note 2)	320		mJ
I_{AR}	Avalanche Current (Note 1)	3		A
E_{AR}	Repetitive Avalanche Energy (Note 1)	10.7		mJ
dv/dt	Peak Diode Recovery dv/dt (Note 3)	4.5		V/ns
P_D	Power Dissipation ($T_C = 25^\circ\text{C}$) - Derate above 25°C	107	39	W
		0.85	0.31	W/ $^\circ\text{C}$
T_J, T_{STG}	Operating and Storage Temperature Range	-55 to +150		$^\circ\text{C}$
T_L	Maximum lead temperature for soldering purposes, 1/8" from case for 5 seconds	300		$^\circ\text{C}$

* Drain current limited by maximum junction temperature.

Thermal Characteristics

Symbol	Parameter	FQP3N80C	FQPF3N80C	Units
$R_{\theta JC}$	Thermal Resistance, Junction-to-Case	1.17	3.2	$^\circ\text{C}/\text{W}$
$R_{\theta CS}$	Thermal Resistance, Case-to-Sink Typ.	0.5	--	$^\circ\text{C}/\text{W}$
$R_{\theta JA}$	Thermal Resistance, Junction-to-Ambient	62.5	62.5	$^\circ\text{C}/\text{W}$

Electrical Characteristics

$T_C = 25^\circ\text{C}$ unless otherwise noted

Symbol	Parameter	Test Conditions	Min	Typ	Max	Units
Off Characteristics						
BV_{DSS}	Drain-Source Breakdown Voltage	$V_{GS} = 0\text{ V}, I_D = 250\ \mu\text{A}$	800	--	--	V
$\Delta BV_{DSS} / \Delta T_J$	Breakdown Voltage Temperature Coefficient	$I_D = 250\ \mu\text{A}$, Referenced to 25°C	--	1	--	V/ $^\circ\text{C}$
I_{DSS}	Zero Gate Voltage Drain Current	$V_{DS} = 800\text{ V}, V_{GS} = 0\text{ V}$	--	--	10	μA
		$V_{DS} = 640\text{ V}, T_C = 125^\circ\text{C}$	--	--	100	μA
I_{GSSF}	Gate-Body Leakage Current, Forward	$V_{GS} = 30\text{ V}, V_{DS} = 0\text{ V}$	--	--	100	nA
I_{GSSR}	Gate-Body Leakage Current, Reverse	$V_{GS} = -30\text{ V}, V_{DS} = 0\text{ V}$	--	--	-100	nA

On Characteristics

$V_{GS(th)}$	Gate Threshold Voltage	$V_{DS} = V_{GS}, I_D = 250\ \mu\text{A}$	3.0	--	5.0	V
$R_{DS(on)}$	Static Drain-Source On-Resistance	$V_{GS} = 10\text{ V}, I_D = 1.5\text{ A}$	--	4.0	4.8	Ω
g_{FS}	Forward Transconductance	$V_{DS} = 50\text{ V}, I_D = 1.5\text{ A}$ (Note 4)	--	3	--	S

Dynamic Characteristics

C_{iss}	Input Capacitance	$V_{DS} = 25\text{ V}, V_{GS} = 0\text{ V},$ $f = 1.0\text{ MHz}$	--	543	705	pF
C_{oss}	Output Capacitance		--	54	70	pF
C_{riss}	Reverse Transfer Capacitance		--	5.5	7.5	pF

Switching Characteristics

$t_{d(on)}$	Turn-On Delay Time	$V_{DD} = 400\text{ V}, I_D = 3\text{ A},$ $R_G = 25\ \Omega$	--	15	40	ns	
t_r	Turn-On Rise Time		--	43.5	95	ns	
$t_{d(off)}$	Turn-Off Delay Time		(Note 4, 5)	--	22.5	55	ns
t_f	Turn-Off Fall Time		(Note 4, 5)	--	32	75	ns
Q_g	Total Gate Charge	$V_{DS} = 640\text{ V}, I_D = 3\text{ A},$ $V_{GS} = 10\text{ V}$	--	13	16.5	nC	
Q_{gs}	Gate-Source Charge		(Note 4, 5)	--	3.4	--	nC
Q_{gd}	Gate-Drain Charge		(Note 4, 5)	--	5.8	--	nC

Drain-Source Diode Characteristics and Maximum Ratings

I_S	Maximum Continuous Drain-Source Diode Forward Current	--	--	3.0	A	
I_{SM}	Maximum Pulsed Drain-Source Diode Forward Current	--	--	12	A	
V_{SD}	Drain-Source Diode Forward Voltage	$V_{GS} = 0\text{ V}, I_S = 3.0\text{ A}$	--	--	1.4	V
t_{rr}	Reverse Recovery Time	$V_{GS} = 0\text{ V}, I_S = 3.0\text{ A},$	--	642	--	ns
Q_{rr}	Reverse Recovery Charge	$di_F / dt = 100\text{ A}/\mu\text{s}$ (Note 4)	--	4.0	--	μC

Notes:

1. Repetitive Rating : Pulse width limited by maximum junction temperature
2. $L = 67\text{ mH}, I_{AS} = 3.0\text{ A}, V_{DD} = 50\text{ V}, R_G = 25\ \Omega$, Starting $T_J = 25^\circ\text{C}$
3. $I_{SD} \leq 3\text{ A}, di/dt \leq 200\text{ A}/\mu\text{s}, V_{DD} \leq BV_{DSS}$, Starting $T_J = 25^\circ\text{C}$
4. Pulse Test : Pulse width $\leq 300\ \mu\text{s}$, Duty cycle $\leq 2\%$
5. Essentially independent of operating temperature

Typical Characteristics

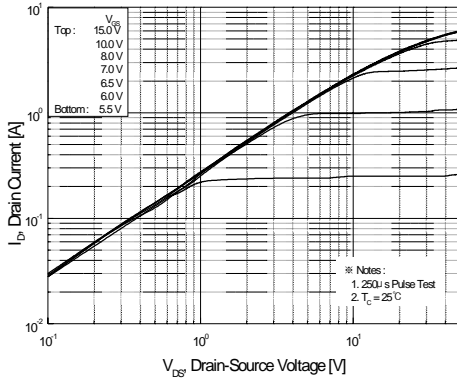

Figure 1. On-Region Characteristics

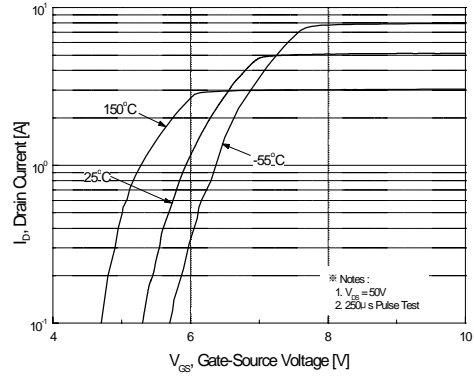

Figure 2. Transfer Characteristics

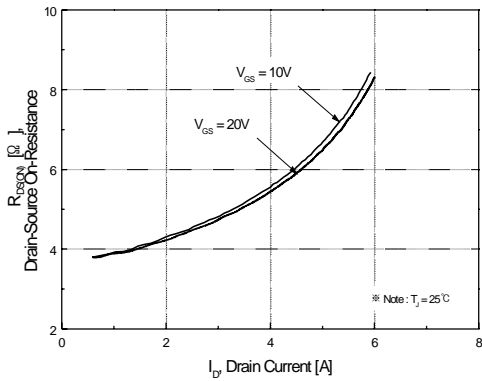

Figure 3. On-Resistance Variation vs Drain Current and Gate Voltage

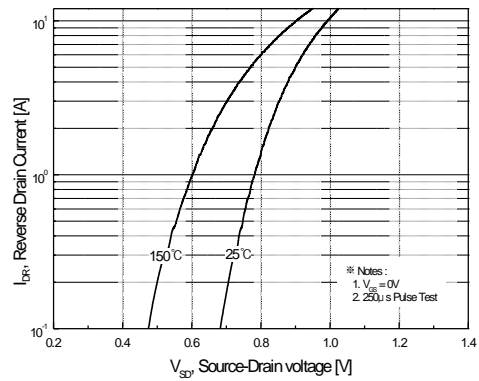

Figure 4. Body Diode Forward Voltage Variation with Source Current and Temperature

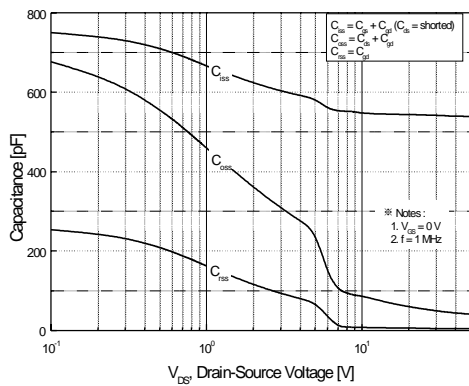

Figure 5. Capacitance Characteristics

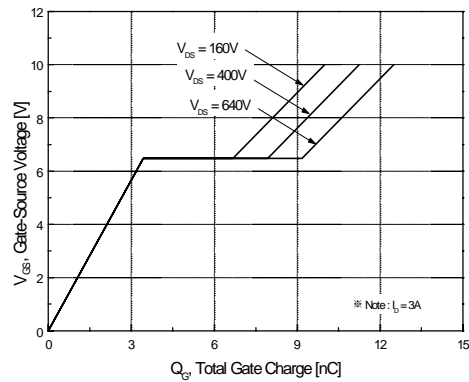

Figure 6. Gate Charge Characteristics

Typical Characteristics (Continued)

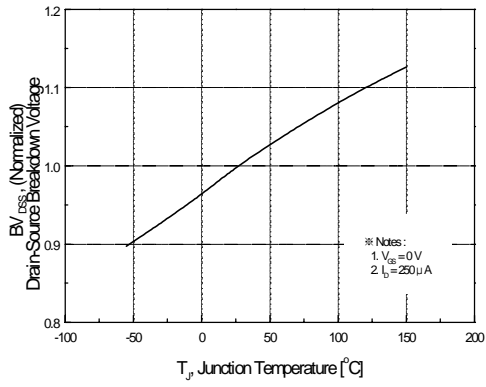

Figure 7. Breakdown Voltage Variation vs Temperature

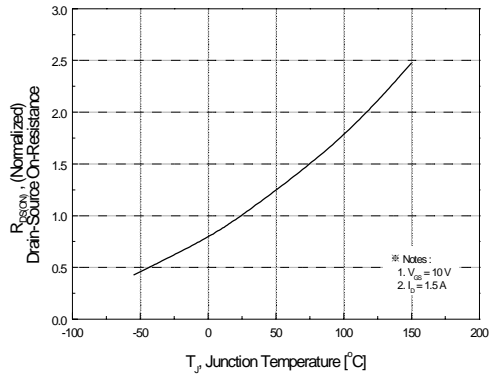

Figure 8. On-Resistance Variation vs Temperature

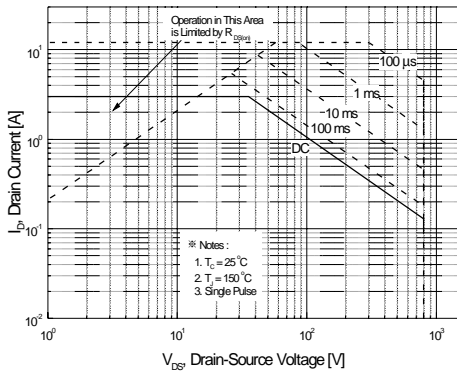

Figure 9-1. Maximum Safe Operating Area for FQP3N80C

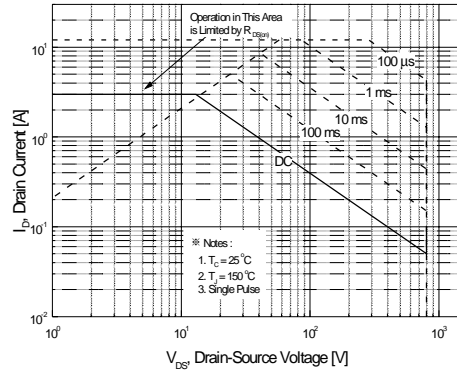

Figure 9-2. Maximum Safe Operating Area for FQPF3N80C

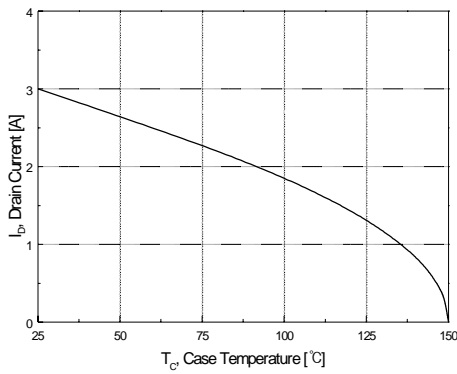

Figure 10. Maximum Drain Current vs Case Temperature

Typical Characteristics (Continued)

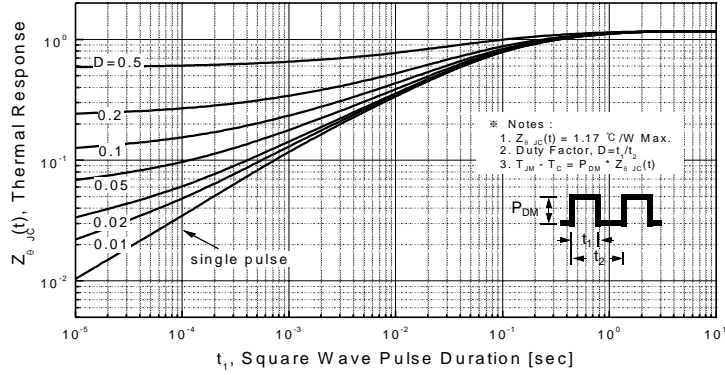

Figure 11-1. Transient Thermal Response Curve for FQP3N80C

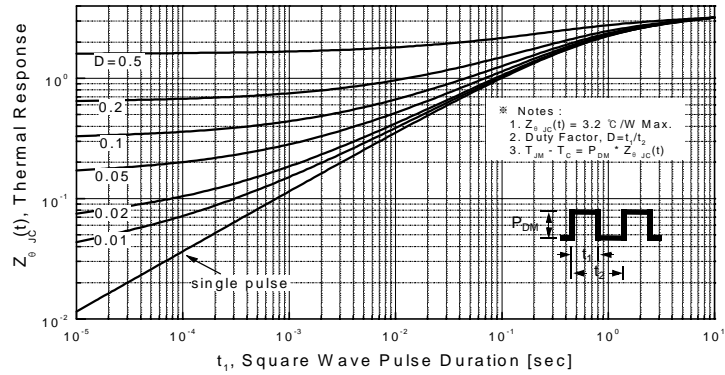
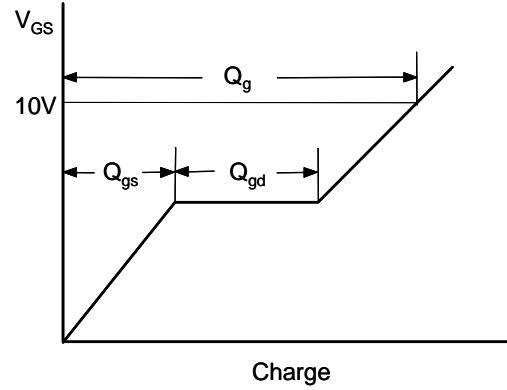
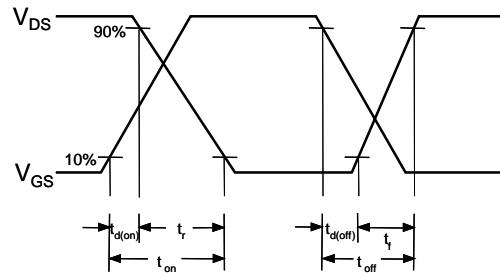
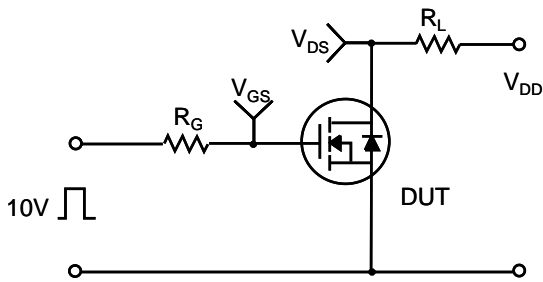

Figure 11-2. Transient Thermal Response Curve for FQPF3N80C

Gate Charge Test Circuit & Waveform



Resistive Switching Test Circuit & Waveforms



Unclamped Inductive Switching Test Circuit & Waveforms

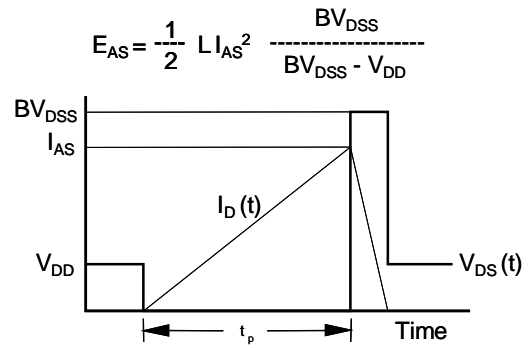
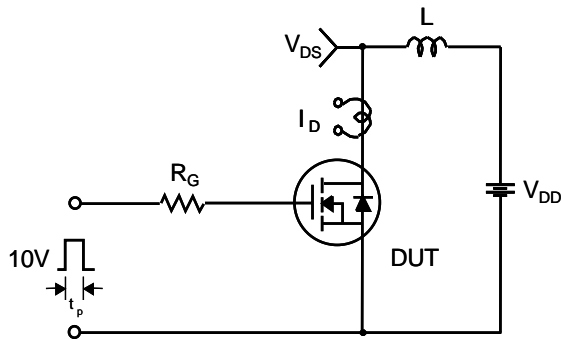

Peak Diode Recovery dv/dt Test Circuit & Waveforms



Package Dimensions

TO-220

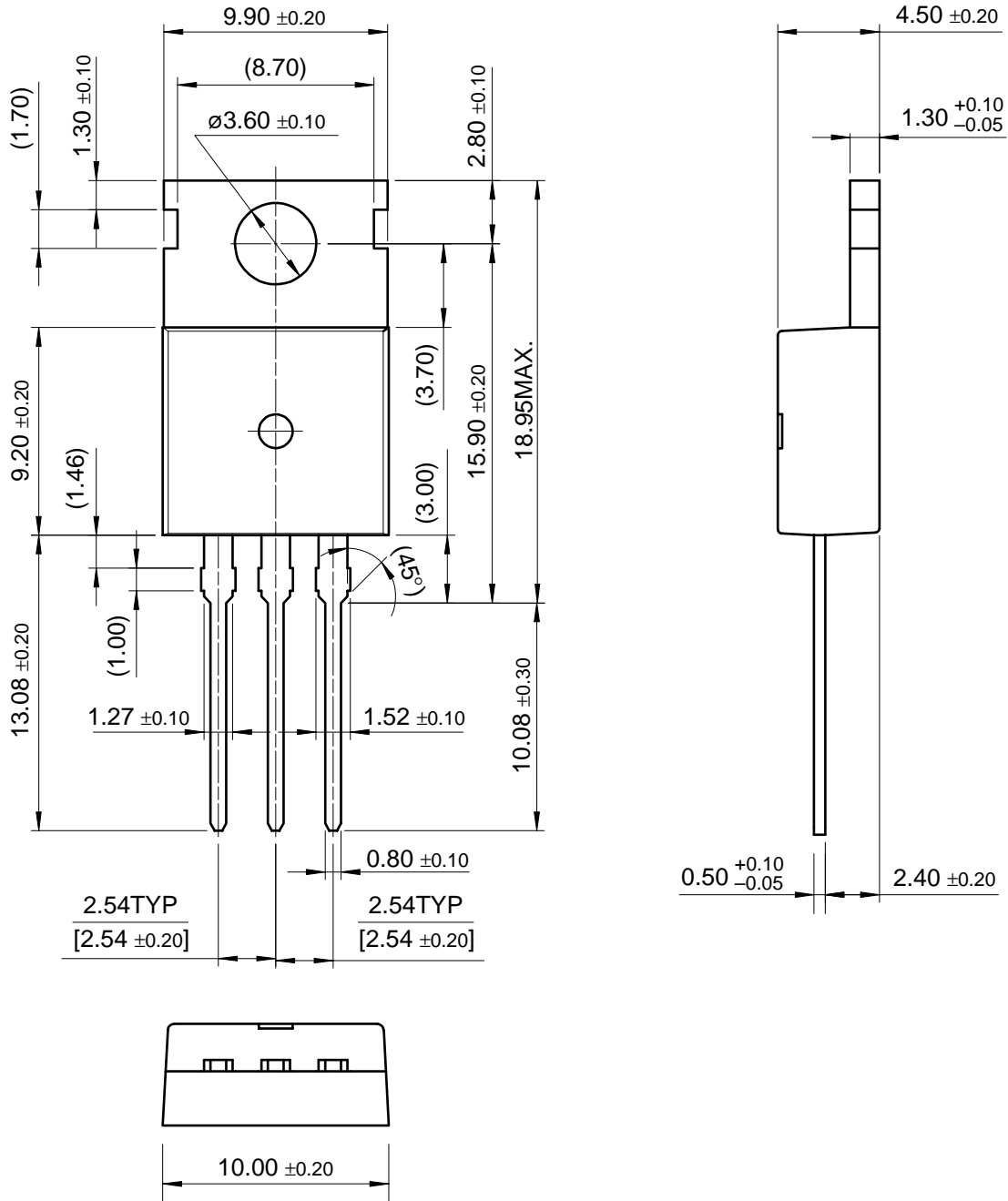

FQP3N80C/FQPF3N80C

Dimensions in Millimeters

Package Dimensions (Continued)

TO-220F



FQP3N80C/FQPF3N80C

Dimensions in Millimeters

TRADEMARKS

The following are registered and unregistered trademarks Fairchild Semiconductor owns or is authorized to use and is not intended to be an exhaustive list of all such trademarks.

ACE ^x TM	FACT TM	ImpliedDisconnect TM	PACMAN TM	SPM TM
ActiveArray TM	FACT Quiet series TM	ISOPLANAR TM	POP TM	Stealth TM
Bottomless TM	FAST [®]	LittleFET TM	Power247 TM	SuperSOT TM -3
CoolFET TM	FAST ^r TM	MicroFET TM	PowerTrench [®]	SuperSOT TM -6
CROSSVOLT TM	FRFET TM	MicroPak TM	QFET TM	SuperSOT TM -8
DOMET TM	GlobalOptoisolator TM	MICROWIRE TM	QS TM	SyncFET TM
EcoSPARK TM	GTO TM	MSX TM	QT Optoelectronics TM	TinyLogic [®]
E ² CMOS TM	HiSeC TM	MSXPro TM	Quiet Series TM	TruTranslation TM
EnSigna TM	I ² C TM	OCX TM	RapidConfigure TM	UHC TM
Across the board. Around the world. TM		OCXPro TM	RapidConnect TM	UltraFET [®]
The Power Franchise TM		OPTOLOGIC [®]	SILENT SWITCHER [®]	VCX TM
Programmable Active Droop TM		OPTOPLANAR TM	SMART START TM	

DISCLAIMER

FAIRCHILD SEMICONDUCTOR RESERVES THE RIGHT TO MAKE CHANGES WITHOUT FURTHER NOTICE TO ANY PRODUCTS HEREIN TO IMPROVE RELIABILITY, FUNCTION OR DESIGN. FAIRCHILD DOES NOT ASSUME ANY LIABILITY ARISING OUT OF THE APPLICATION OR USE OF ANY PRODUCT OR CIRCUIT DESCRIBED HEREIN; NEITHER DOES IT CONVEY ANY LICENSE UNDER ITS PATENT RIGHTS, NOR THE RIGHTS OF OTHERS.

LIFE SUPPORT POLICY

FAIRCHILD'S PRODUCTS ARE NOT AUTHORIZED FOR USE AS CRITICAL COMPONENTS IN LIFE SUPPORT DEVICES OR SYSTEMS WITHOUT THE EXPRESS WRITTEN APPROVAL OF FAIRCHILD SEMICONDUCTOR CORPORATION.

As used herein:

1. Life support devices or systems are devices or systems which, (a) are intended for surgical implant into the body, or (b) support or sustain life, or (c) whose failure to perform when properly used in accordance with instructions for use provided in the labeling, can be reasonably expected to result in significant injury to the user.
2. A critical component is any component of a life support device or system whose failure to perform can be reasonably expected to cause the failure of the life support device or system, or to affect its safety or effectiveness.

PRODUCT STATUS DEFINITIONS

Definition of Terms

Datasheet Identification	Product Status	Definition
Advance Information	Formative or In Design	This datasheet contains the design specifications for product development. Specifications may change in any manner without notice.
Preliminary	First Production	This datasheet contains preliminary data, and supplementary data will be published at a later date. Fairchild Semiconductor reserves the right to make changes at any time without notice in order to improve design.
No Identification Needed	Full Production	This datasheet contains final specifications. Fairchild Semiconductor reserves the right to make changes at any time without notice in order to improve design.
Obsolete	Not In Production	This datasheet contains specifications on a product that has been discontinued by Fairchild semiconductor. The datasheet is printed for reference information only.

Home >> Find products >>

FQPF3N80C

800V N-Channel Advance Q-FET C-Series

Contents

- [General description](#)
- [Features](#)
- [Product status/pricing/packageing](#)
- [Order Samples](#)
- [Models](#)
- [Qualification Support](#)

General description

These N-Channel enhancement mode power field effect transistors are produced using Fairchild's proprietary, planar stripe, DMOS technology. This advanced technology has been especially tailored to minimize on-state resistance, provide superior switching performance, and withstand high energy pulse in the avalanche and commutation mode. These devices are well suited for high efficiency switch mode power supplies.

[back to top](#)

Features

- 3.0A, 800V, $R_{DS(on)} = 4.8 @ V_{GS} = 10 V$
- Low gate charge (typical 13 nC)
- Low Crss (typical 5.5 pF)
- Fast switching
- 100% avalanche tested
- Improved dv/dt capability

[back to top](#)

Product status/pricing/packageing

BUY

Product	Product status	Pb-free Status	Pricing*	Package type	Leads	Packing method	Package Marking Convention**
FQPF3N80C	Full Production		\$0.99	TO-220F	3	RAIL	Line 1: \$Y (Fairchild logo) &Z (Asm. Plant Code)

BUY

Datasheet

[Download this datasheet](#)



[e-mail this datasheet](#)



This page

[Print version](#)

Related Links

[Request samples](#)

[How to order products](#)



[Product Change Notices \(PCNs\)](#)

[Support](#)

[Sales support](#)

[Quality and reliability](#)

[Design center](#)

							&4 (4-Digit Date Code) Line 2: FQPF Line 3: 3N80C
FQPF3N80CYDTU	Full Production		\$0.99	TO-220F	3	RAIL	Line 1: \$Y (Fairchild logo) &Z (Asm. Plant Code) &4 (4-Digit Date Code)

* Fairchild 1,000 piece Budgetary Pricing

** A sample button will appear if the part is available through Fairchild's on-line samples program. If there is no sample button, please contact a [Fairchild distributor](#) to obtain samples



Indicates product with Pb-free second-level interconnect. For more information [click here](#).

Package marking information for product FQPF3N80C is available. [Click here for more information](#).

[back to top](#)

Models

Package & leads	Condition	Temperature range	Vcc range	Software version	Revision date
PSPICE					
TO-220F-3	Electrical/Thermal	-55°C to 150°C	0V to 40V	OrCAD 10.3	Jul 9, 2007

[back to top](#)

Qualification Support

Click on a product for detailed qualification data

Product
FQPF3N80C
FQPF3N80CYDTU

[back to top](#)

© 2007 Fairchild Semiconductor

