

FAN7318

LCD Backlight Inverter Drive IC

Features

- High-Efficiency Single-Stage Power Conversion
- Wide Input Voltage Range: 6V to 30V
- Backlight Lamp Ballast and Soft Dimming
- Minimal External Components Required
- Precision Voltage Reference Trimmed to 2%
- Half-Bridge Topology
- Soft-Start
- PWM Control at Fixed Frequency
- Analog Dimming Function
- Burst Dimming Function
- Programmable Striking Frequency
- Open-Lamp Protection
- Open-Lamp Regulation
- Short-Lamp Protection
- CMP-High Protection
- FB-High Protection
- Thermal Shutdown
- 20-Pin SOIC

Applications

- LCD TV
- LCD Monitor

Description

The FAN7318 is a LCD backlight inverter drive IC that controls P-N half-bridge topology.

The FAN7318 provides a low-cost solution and reduces external components by integrating proprietary wave rectifiers for open-lamp protection and regulation. The operating voltage range of the FAN7318 is wide, so an external regulator isn't necessary to supply the voltage to the IC.

The FAN7318 provides various protections, such as open-lamp regulation, open-lamp protection, short-Lamp protection, CMP-high protection, and FB-high protection, to increase the system reliability. The FAN7318 provides burst dimming and analog dimming.

The FAN7318 is available in a 20-SOIC package.

20-SOIC



Ordering Information

Part Number	Operating Temperature	Package	Packing Method
FAN7318M	-25 to +85°C	20-Lead, Small Outline Integrated Circuit (SOIC)	Rail
FAN7318MX			Tape & Reel

Block Diagram

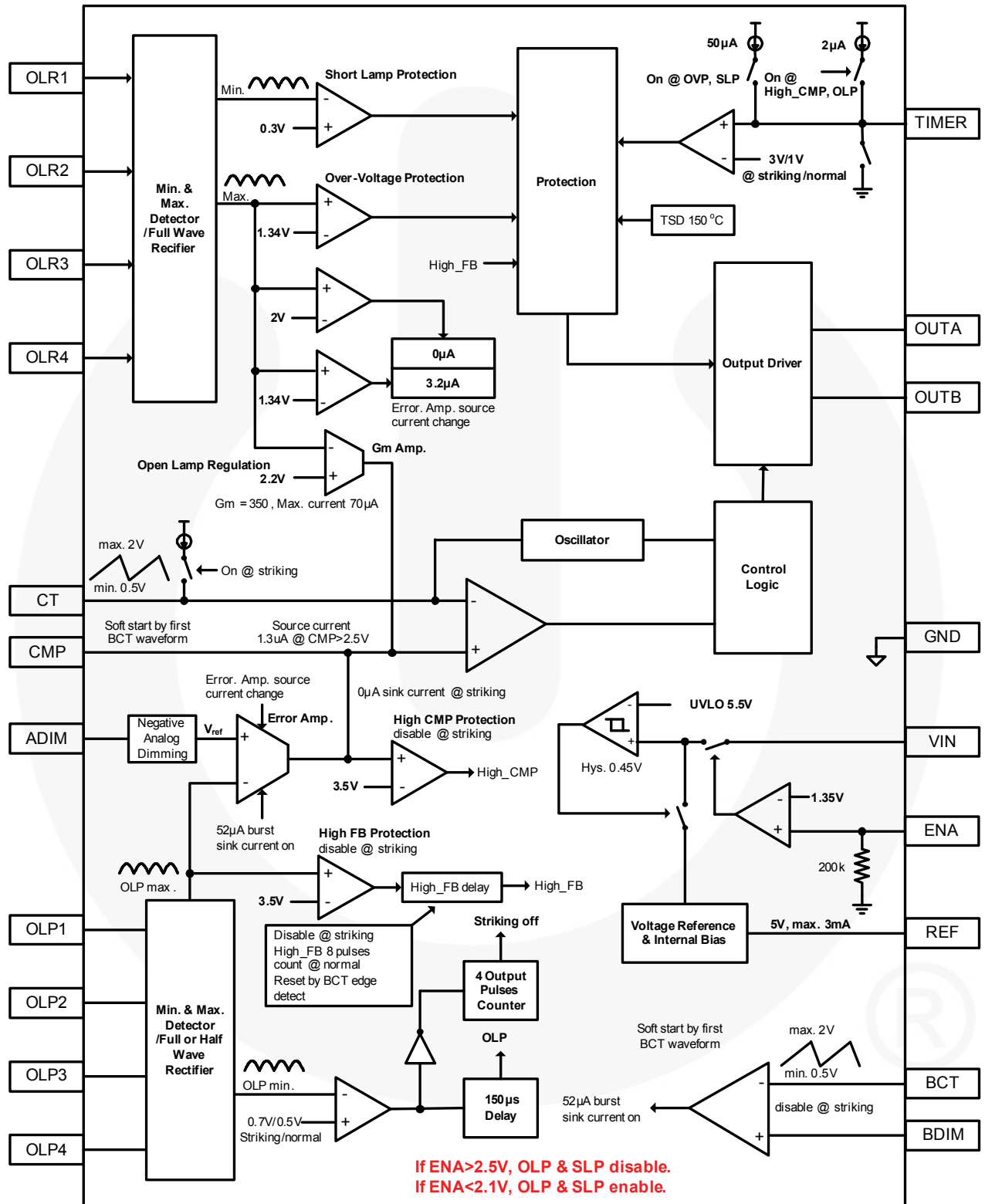

Figure 1. Internal Block Diagram

Pin Configuration

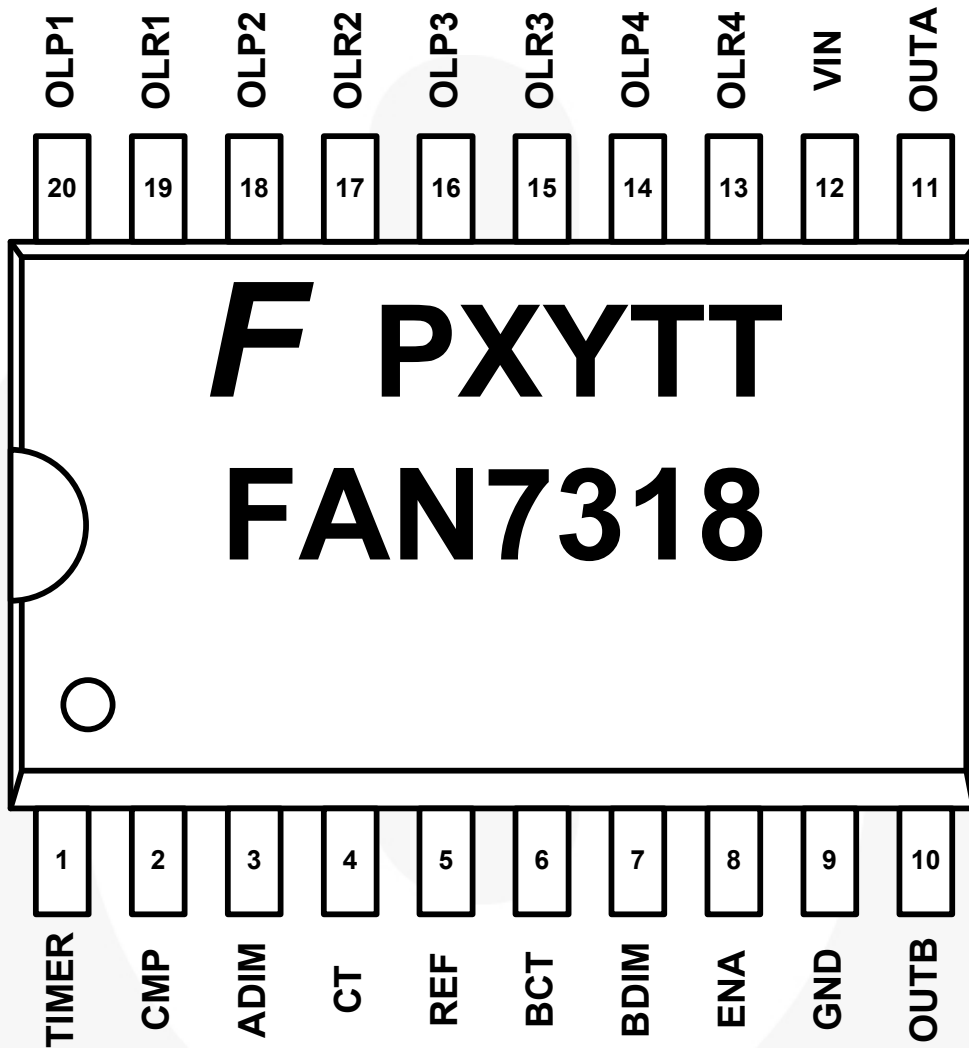

Figure 2. Package Diagram

Pin Definitions

Pin #	Name	Description
1	TIMER	This pin is for protection delay time setting.
2	CMP	Error amplifier output. Typically, a compensation capacitor is connected to this pin from the ground.
3	ADIM	This pin is the input for negative analog dimming.
4	CT	This pin is for programming the switching frequency. Typically, a capacitor is connected to this pin from ground and a resistor is connected to this pin from the REF pin.
5	REF	This pin is 5V reference output. Typically, resistors are connected to this pin from the CT pin and the BCT pin.
6	BCT	This pin is for programming the frequency of the burst dimming. Typically, a capacitor is connected to this pin from ground and a resistor is connected to this pin from the REF pin.
7	BDIM	This pin is the input for negative burst dimming. The voltage range of 0.5 to 2V at this pin controls burst mode duty cycle from 0% to 100%.
8	ENA	This pin is for turning on/off the IC.
9	GND	This pin is the ground.
10	OUTB	This pin is NMOS gate-drive output.
11	OUTA	This pin is PMOS gate-drive output.
12	VIN	This pin is the supply voltage of the IC.
13	OLR4	This pin is for open-lamp regulation. Its functions are the same as the OLR1 pin.
14	OLP4	This pin is for open-lamp protection and feedback control of lamp currents. Its functions are the same as the OLP1 pin.
15	OLR3	This pin is for open-lamp regulation. Its functions are the same as the OLR1 pin.
16	OLP3	This pin is for open-lamp protection and feedback control of lamp currents. Its functions are the same as the OLP1 pin.
17	OLR2	This pin is for open-lamp regulation. Its functions are the same as the OLR1 pin.
18	OLP2	This pin is for open-lamp protection and feedback control of lamp currents. Its functions are the same as the OLP1 pin.
19	OLR1	This pin is for open-lamp regulation and short-lamp protection. It has the same functions as other OLR pins and is connected to the full-wave rectifier internally. When the maximum of rectified OLR inputs is between 1.34V and 2V, the error amplifier output current is limited to 3.2 μ A; and when the maximum of rectified OLR inputs reaches 2V, the error amplifier output current is 0A and its output voltage maintains constant. The maximum of rectified OLR inputs is inputted to the negative of another error amplifier for feedback control of lamp voltage. When the maximum of rectified OLR inputs is more than 2.2V, another error amplifier for OLR is operating and lamp voltage is regulated. In normal mode, if the maximum of rectified OLR inputs is higher than 1.35V or if the minimum of rectified OLR inputs is lower than 0.3V for a predetermined time by the TIMER pin capacitor and an internal current source 50 μ A, the IC shuts down to protect the system in over-voltage condition, short-lamp condition, respectively.
20	OLP1	This pin is for open-lamp protection and feedback control of lamp currents. It has the same functions as other OLP pins and is connected to the half-wave rectifier and the full-wave rectifier internally. In striking mode, if the minimum of rectified OLP inputs is less than 0.7V for a predetermined time by the TIMER pin capacitor and an internal current source or, in normal mode, if the minimum of rectified OLP inputs is less than 0.5V for another predetermined time by the TIMER pin capacitor and another internal current source; the IC shuts down to protect the system in open-lamp condition. The maximum of rectified OLP inputs is inputted to the negative of the error amplifier for feedback control of lamp current.

Absolute Maximum Ratings

Stresses exceeding the absolute maximum ratings may damage the device. The device may not function or be operable above the recommended operating conditions and stressing the parts to these levels is not recommended. In addition, extended exposure to stresses above the recommended operating conditions may affect device reliability. The absolute maximum ratings are stress ratings only.

Symbol	Parameter	Min.	Max.	Unit
V_{IN}	IC Supply Voltage	6	30	V
T_A	Operating Temperature Range	-25	+85	°C
T_J	Operating Junction Temperature		+150	°C
T_{STG}	Storage Temperature Range	-65	+150	°C
θ_{JA}	Thermal Resistance Junction-Air ^(1,2)		90	°C/W
P_D	Power Dissipation		1.4	W

Notes:

1. Thermal resistance test board; size: 76.2mm x 114.3mm x 1.6mm (1S0P); JEDEC standard: JESD51-2, JESD51-3.
2. Assume no ambient airflow.

Pin Breakdown Voltage

Pin #	Name	Value	Unit
1	TIMER	7	V
2	CMP	7	
3	ADIM	7	
4	CT	7	
5	REF	7	
6	BCT	7	
7	BDIM	7	
8	ENA	7	
9	GND		
10	OUTB	10	
11	OUTA	30	
12	VIN	30	
13	OLR4	±7	
14	OLP4	±7	
15	OLR3	±7	
16	OLP3	±7	
17	OLR2	±7	
18	OLP2	±7	
19	OLR1	±7	
20	OLP1	±7	

Electrical Characteristics

For typical values, $T_A=25^{\circ}\text{C}$, $V_{IN}=15\text{V}$, and $-25^{\circ}\text{C} \leq T_A \leq 85^{\circ}\text{C}$, unless otherwise specified. Specifications to $-25^{\circ}\text{C} \sim 85^{\circ}\text{C}$ are guaranteed by design based on final characterization results.

Symbol	Parameter	Test Conditions	Min.	Typ.	Max.	Unit
Under-Voltage Lockout Section (UVLO)						
V_{th}	Start Threshold Voltage	Increase V_{IN}	4.9	5.2	5.5	V
V_{thys}	Start Threshold Voltage Hysteresis	Decrease V_{IN}	0.20	0.45	0.60	V
I_{st}	Startup Current	$V_{IN}=4.5\text{V}$	10	70	100	μA
I_{op}	Operating Supply Current	$V_{IN}=15\text{V}$, Not Switching	0.5	2.0	3.5	mA
ON/OFF Section						
V_{on}	On-State Input Voltage		1.4		5.0	V
V_{off}	Off-State Input Voltage				0.7	V
I_{sb}	Standby Current	ENA=0V	50	120	190	μA
R_{ENA}	Pull-Down Resistor	ENA=2V	120	200	280	$\text{k}\Omega$
Reference Section (Recommend $1\mu\text{F}$ X7R Capacitor)						
V_5	5V Regulation Voltage		4.9	5.0	5.1	V
V_{5line}	5V Line Regulation	$6 \leq V_{IN} \leq 30\text{V}$		4	50	mV
V_{5load}	5V Load Regulation	$10\mu\text{A} \leq I_5 \leq 3\text{mA}$		4	50	mV
Oscillator Section (Main)						
f_{osc}	Oscillation Frequency	$T_A=25^{\circ}\text{C}$, $C_T=220\text{pF}$, $R_T=100\text{k}\Omega$	101.3	105.0	108.3	kHz
		$C_T=220\text{pF}$, $R_T=100\text{k}\Omega$	101	105	109	
f_{str}	Oscillator Frequency in Striking Mode	$T_A=25^{\circ}\text{C}$, $C_T=220\text{pF}$, $R_T=100\text{k}\Omega$	127.5	132.0	136.5	kHz
		$C_T=20\text{pF}$, $R_T=100\text{k}\Omega$	127	132	137	
I_{ctdcs}	CT Discharge Current	Striking	1.03	1.18	1.33	mA
I_{ctdc}		Normal	770	870	970	μA
I_{ctcs}	CT Charge Current	Striking	-15	-12	-9	μA
V_{cth}	CT High Voltage			2		V
V_{ctl}	CT Low Voltage			0.45		V
Oscillator Section (Burst)						
f_{oscb}	Burst Oscillation Frequency	$T_A=25^{\circ}\text{C}$, $BCT=4.7\text{nF}$, $BRT=1.4\text{M}\Omega$	324	333	345	Hz
		$BCT=4.7\text{nF}$, $BRT=1.4\text{M}\Omega$	320	333	346	
I_{bctdc}	BCT Discharge current		20	26	32	μA
V_{bcth}	BCT High Voltage			2		V
V_{bctl}	BCT Low Voltage			0.5		V

Electrical Characteristics (Continued)

For typical values, $T_A=25^\circ\text{C}$, $V_{IN}=15\text{V}$, and $-25^\circ\text{C} \leq T_A \leq 85^\circ\text{C}$, unless otherwise specified. Specifications to $-25^\circ\text{C} \sim 85^\circ\text{C}$ are guaranteed by design based on final characterization results.

Symbol	Parameter	Test Conditions	Min.	Typ.	Max.	Unit
Analog Dimming Section						
$A_{V_{\text{rexx}}}$	Reference Voltage	ADIM=0V, $T_A=25^\circ\text{C}$	1.225	1.310	1.402	V
		ADIM=0V	1.212	1.310	1.408	
		ADIM=0.5V		1.16		
		ADIM=1.0V		0.99		
Error Amplifier Section						
I_{sin}	Output Sink Current	OLP=2.5V, ADIM=2.5V	63	76	94	μA
I_{sur1}	Output Source Current 1	OLP=0V, ADIM=0V	-65	-50	-35	μA
I_{sur2}	Output Source Current 2	CMP=3V	-1.7	-1.3	-0.9	μA
I_{bsin}	Burst CMP Sink Current	BDIM=5V, BCT=0V	41	52	63	μA
I_{olpi}	OLP Input Current	OLP=2V		0		μA
I_{olpo}	OLP Output Current	OLP=-2V	-30	-20	-10	μA
V_{Ipx}	Rectifiers Output of OLP	OLP=0.3V		0.31		V
		OLP=1.5V		1.5		V
V_{olpr}	OLP Input Voltage Range ⁽³⁾		-4		4	V
Open-Lamp Regulation Section						
I_{olr1}	Error Amplifier Source Current for Open-Lamp Regulation	Striking, OLR=1.6V	-4.0	-3.4	-2.9	μA
I_{olr2}		OLR Sweep		0		μA
V_{olr1}	Open-Lamp Regulation Voltage 1	OLR Sweep	1.24	1.34	1.44	V
V_{olr2}	Open-Lamp Regulation Voltage 2	Striking, OLR Sweep	1.88	1.98	2.08	V
V_{olr3}	Open-Lamp Regulation Voltage 3		2.1	2.2	2.3	V
G_{mOLR}	OLR Error Amplifier Trans-conductance		180	310	440	μmho
I_{ors}	OLR Error Amplifier Sink Current	Normal, OLR=2.5V	50	70	90	μA
I_{olri}	OLR Input Current	OLR=2.5V		0		μA
I_{olro}	OLR Output Current	OLR=-2.5V	-35	-25	-15	μA
V_{olrr}	OLR Input Voltage Range ⁽³⁾		-4		4	V

Note:

3. These parameters, although guaranteed, are not 100% tested in production.

Electrical Characteristics (Continued)

For typical values, $T_A=25^\circ\text{C}$, $V_{IN}=15\text{V}$, and $-25^\circ\text{C} \leq T_A \leq 85^\circ\text{C}$, unless otherwise specified. Specifications to $-25^\circ\text{C} \sim 85^\circ\text{C}$ are guaranteed by design based on final characterization results.

Symbol	Parameter	Test Conditions	Min.	Typ.	Max.	Unit
Protection Section						
V_{olp0}	Open-Lamp Protection Voltage 0 ⁽⁴⁾	Striking	0.65	0.70	0.75	V
V_{olp1}	Open-Lamp Protection Voltage 1	Sweep OLP	0.42	0.49	0.56	V
V_{cmpr}	CMP-High Protection Voltage	Sweep CMP	3.4	3.5	3.6	V
V_{hfbp}	High-FB Protection Voltage ⁽⁴⁾		3.4	3.5	3.6	V
V_{slp}	Short-Lamp Protection Voltage	Sweep TIMER	0.22	0.30	0.38	V
V_{tmr1}	Timer Threshold Voltage 1	Striking, Sweep TIMER	2.87	3.02	3.17	V
V_{tmr2}	Timer Threshold Voltage 2	Sweep TIMER	1.0	1.1	1.2	V
I_{tmr1}	Timer Current 1	OLP=0V	1.7	2.1	2.5	μA
I_{tmr2}	Timer Current 2	OLR=1.8V	40	50	60	μA
TSD	Thermal Shutdown ⁽⁴⁾			150		$^\circ\text{C}$
V_{ovp}	Over-Voltage Protection Voltage	Sweep OLR	1.24	1.34	1.44	V
dcr	ENA2.3V OLP Disable/Enable Change Voltage		2.1	2.3	2.5	V
Output Section						
V_{pdhv}	PMOS Gate High Voltage ⁽⁴⁾	$V_{IN}=15\text{V}$		V_{IN}		V
V_{phlv}	PMOS Gate Low Voltage	$V_{IN}=15\text{V}$	$V_{IN}-9.5$	$V_{IN}-8.5$	$V_{IN}-7.0$	V
V_{ndhv}	NMOS Gate High Voltage	$V_{IN}=15\text{V}$	8.0	9.0	10.5	V
V_{ndlv}	NMOS Gate Low Voltage ⁽⁴⁾	$V_{IN}=15\text{V}$		0		V
V_{puv}	PMOS Gate Voltage with UVLO Activated	$V_{IN}=4.5\text{V}$	$V_{IN}-0.3$			V
V_{nuv}	NMOS Gate Voltage with UVLO Activated	$V_{IN}=4.5\text{V}$			0.3	V
I_{pdsur}	PMOS Gate Drive Source Current ⁽⁴⁾	$V_{IN}=15\text{V}$		-300		mA
I_{pdsin}	PMOS Gate Drive Sink Current ⁽⁴⁾	$V_{IN}=15\text{V}$		400		mA
I_{ndsur}	NMOS Gate Drive Source Current ⁽⁴⁾	$V_{IN}=15\text{V}$		300		mA
I_{ndsin}	NMOS Gate Drive Sink Current ⁽⁴⁾	$V_{IN}=15\text{V}$		-400		mA
Maximum / Minimum Duty Cycle						
DC_{MIN}	Minimum Duty Cycle ⁽⁴⁾	$f_{osc}=100\text{kHz}$		0		%
DC_{MAX}	Maximum Duty Cycle ⁽⁴⁾	$f_{osc}=100\text{kHz}$	45		49	%

Note:

4. These Parameters, although guaranteed, are not 100% tested in production.

Typical Performance Characteristics

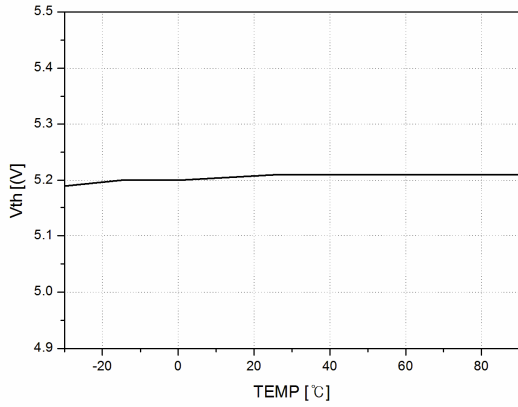

Figure 3. Start Threshold Voltage vs. Temperature

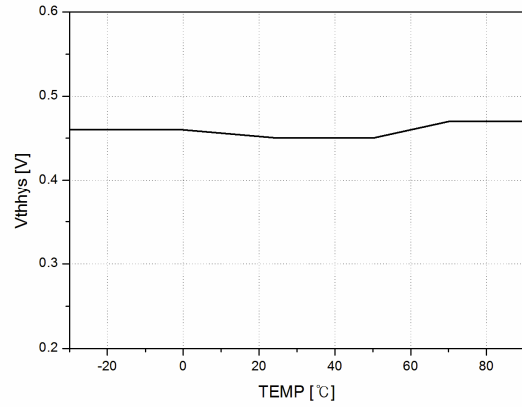

Figure 4. Start Threshold Voltage Hysteresis vs. Temperature

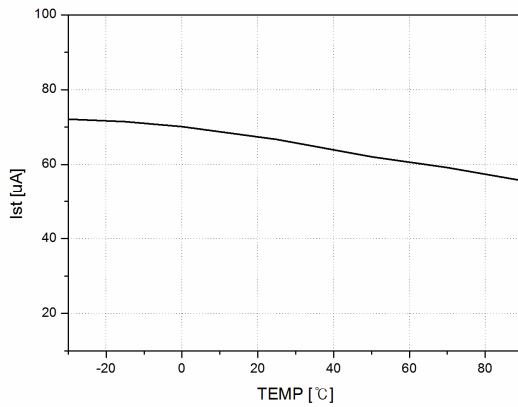

Figure 5. Startup Current vs. Temperature

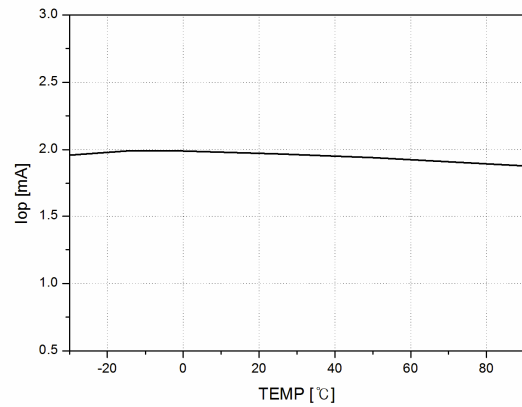

Figure 6. Operating Current vs. Temperature

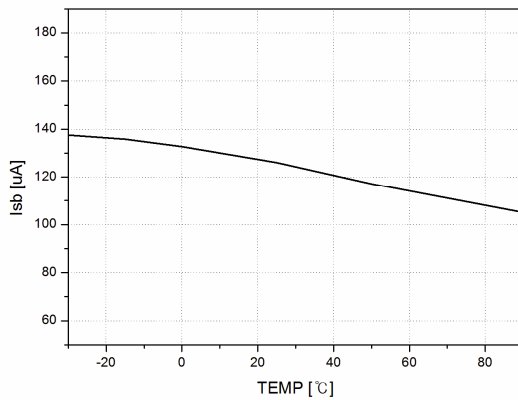

Figure 7. Standby Current vs. Temperature

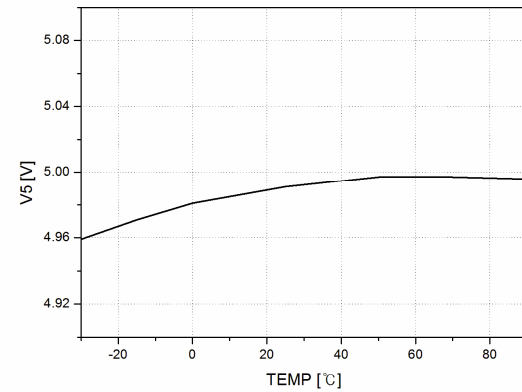

Figure 8. 5V Regulation Voltage vs. Temperature

Typical Performance Characteristics (Continued)

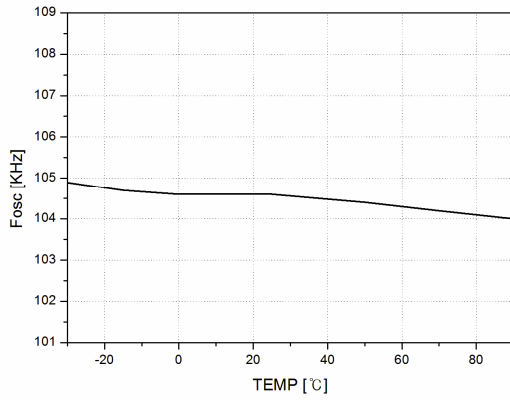

Figure 9. Oscillation Frequency vs. Temperature

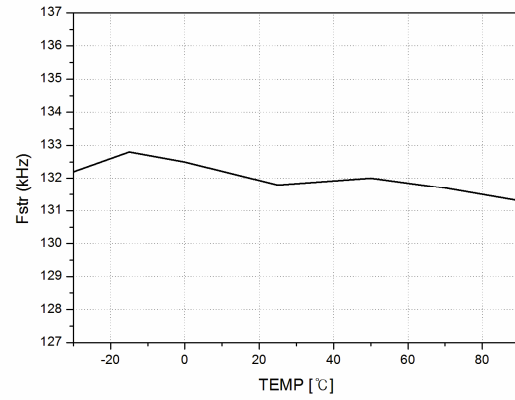

Figure 10. Oscillation Frequency in Striking vs. Temperature

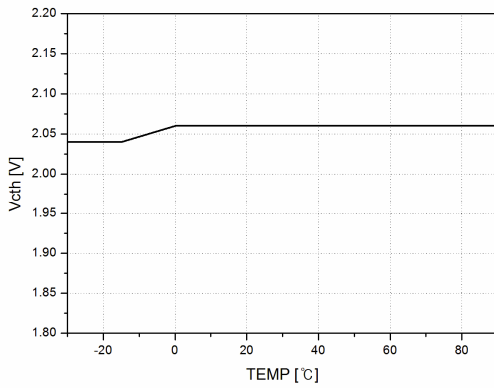

Figure 11. CT High Voltage vs. Temperature

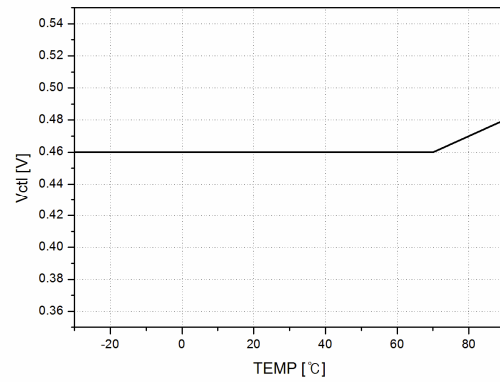

Figure 12. CT Low Voltage vs. Temperature

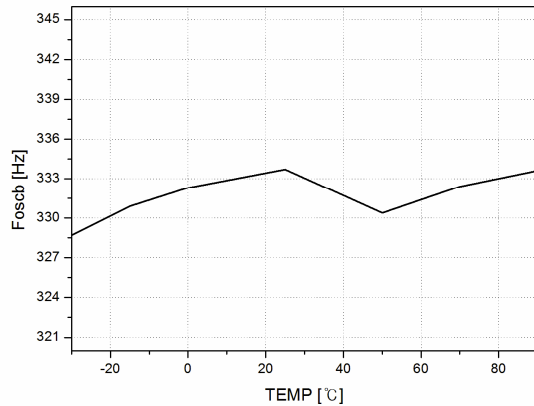

Figure 13. Burst Dimming Frequency vs. Temperature

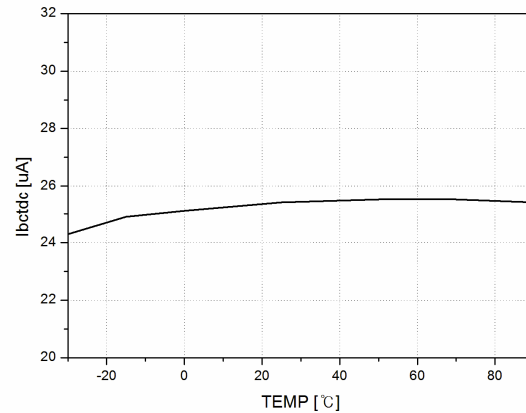

Figure 14. BCT Discharge Current vs. Temperature

Typical Performance Characteristics (Continued)

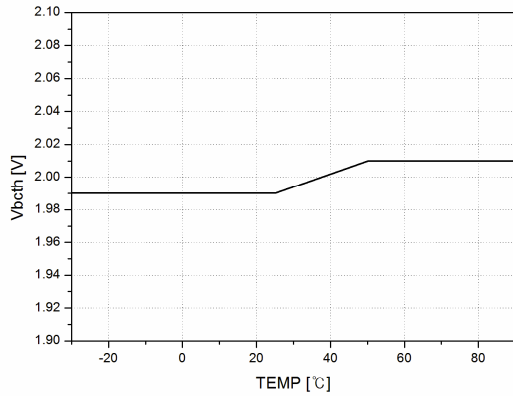

Figure 15. BCT High Voltage vs. Temperature

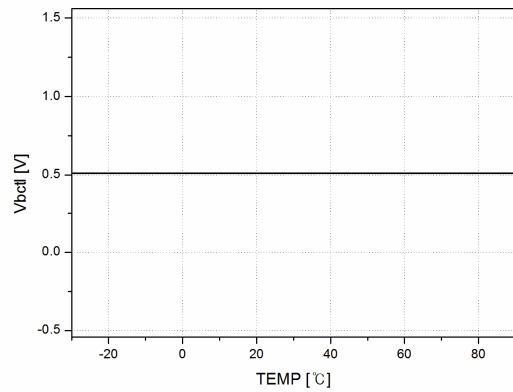

Figure 16. BCT Low Voltage vs. Temperature

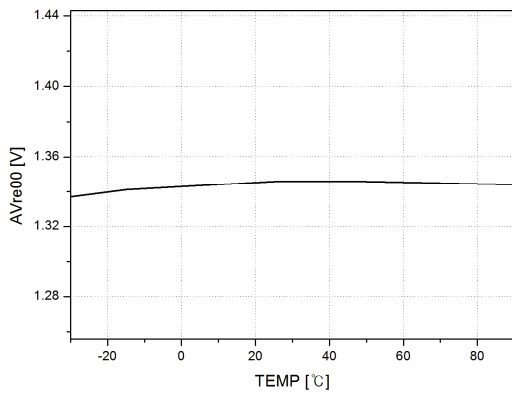

Figure 17. Analog Dimming Reference Voltage 00 vs. Temperature

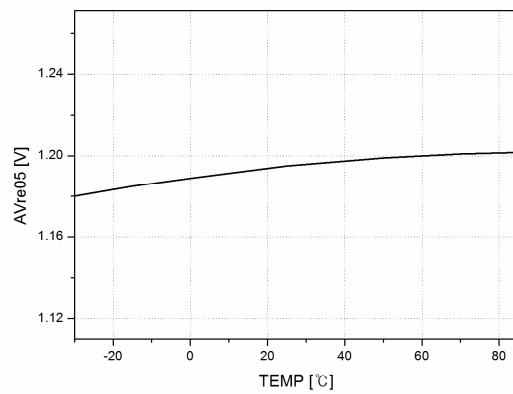

Figure 18. Analog Dimming Reference Voltage 05 vs. Temperature

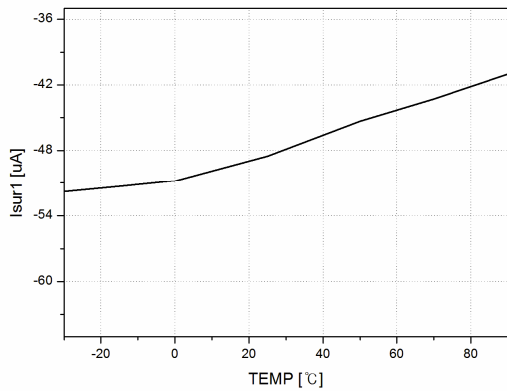

Figure 19. Error Amplifier Source Current 1 vs. Temperature

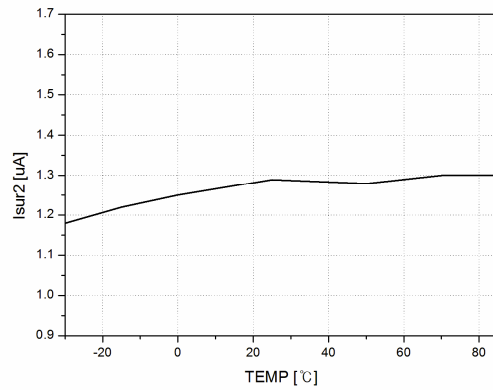

Figure 20. Error Amplifier Source Current 2 vs. Temperature

Typical Performance Characteristics (Continued)

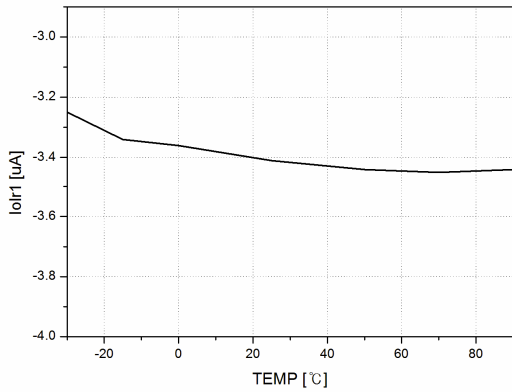

Figure 21. Error Amplifier Source Current for OLR vs. Temperature

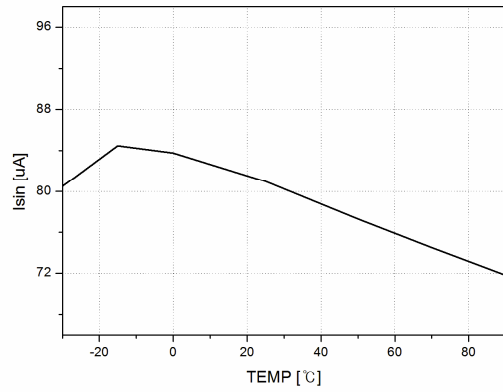

Figure 22. Error Amplifier Sink Current vs. Temperature

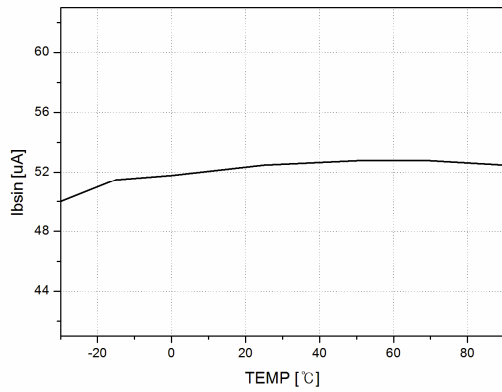

Figure 23. Burst CMP Sink Current vs. Temperature

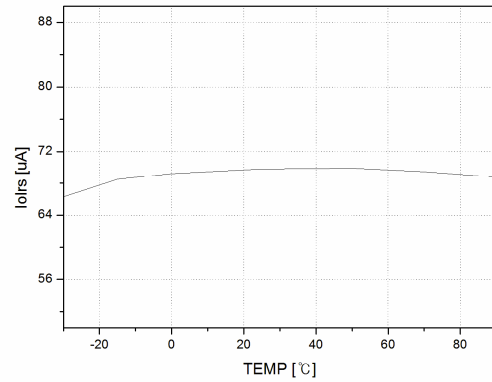

Figure 24. OLR Error Amplifier Sink Current vs. Temperature

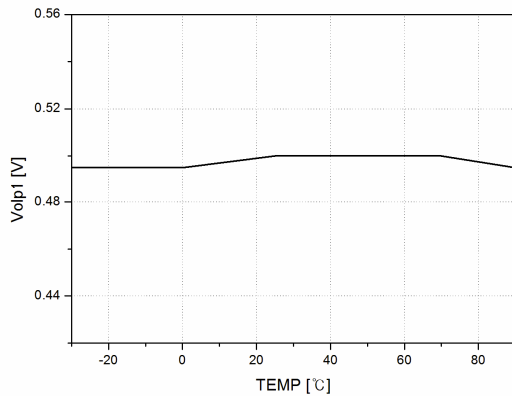

Figure 25. Open-Lamp Protection Voltage 1 vs. Temperature

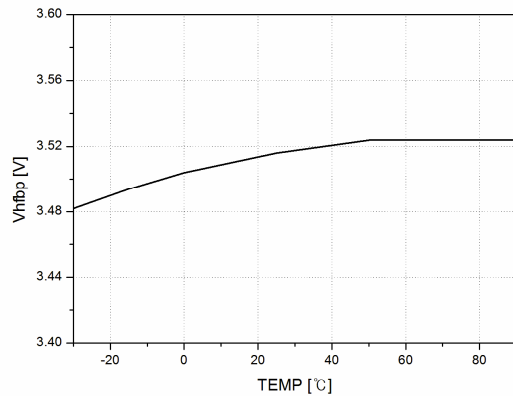

Figure 26. High-FB Protection Voltage vs. Temperature

Typical Performance Characteristics (Continued)

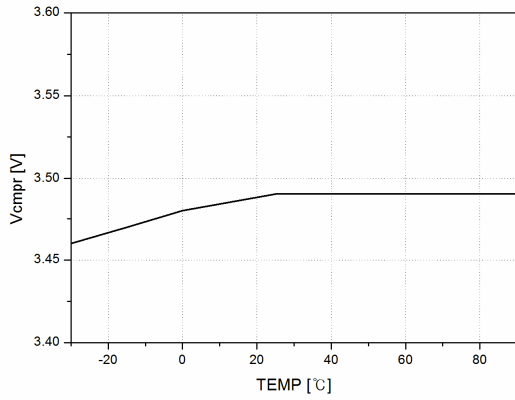

Figure 27. High-CMP Protection Voltage vs. Temperature

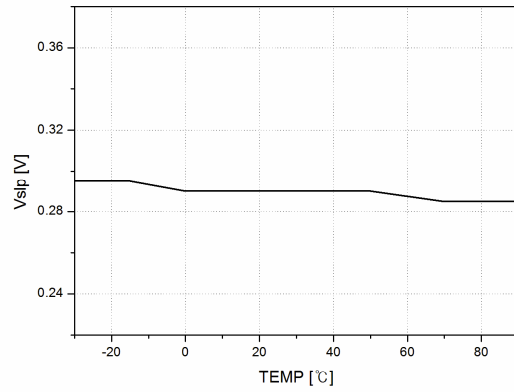

Figure 28. Short-Lamp Protection Voltage vs. Temperature

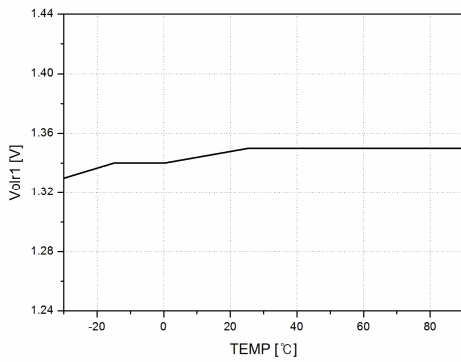

Figure 29. Open Lamp Regulation Voltage 1 vs. Temperature

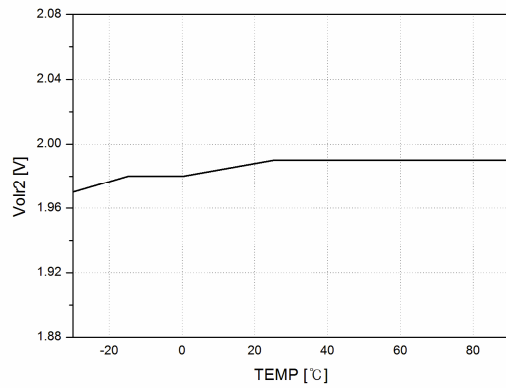

Figure 30. Open Lamp Regulation Voltage 2 vs. Temperature

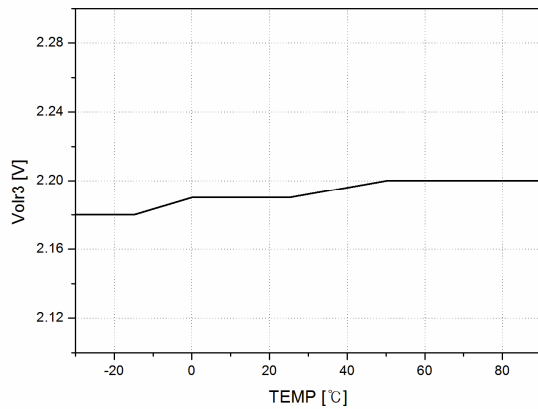

Figure 31. Open Lamp Regulation Voltage 3 vs. Temperature

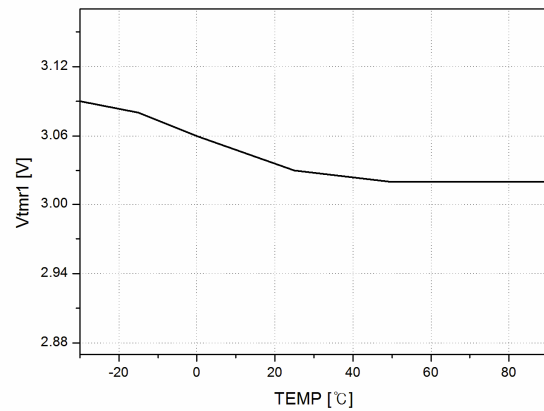

Figure 32. TIMER Threshold Voltage 1 vs. Temperature

Typical Performance Characteristics (Continued)

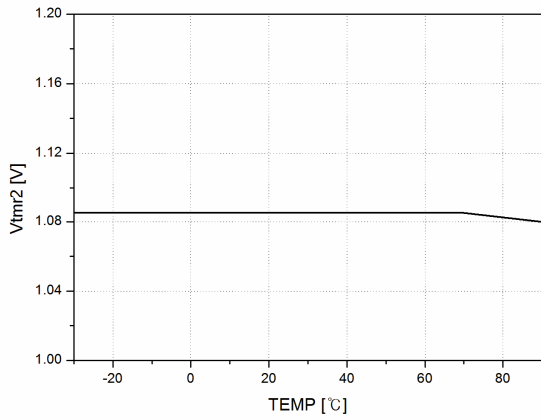

Figure 33. TIMER Threshold Voltage 2 vs. Temperature

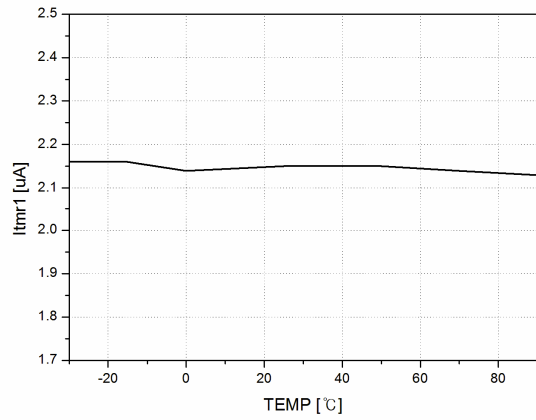

Figure 34. TIMER Current 1 vs. Temperature

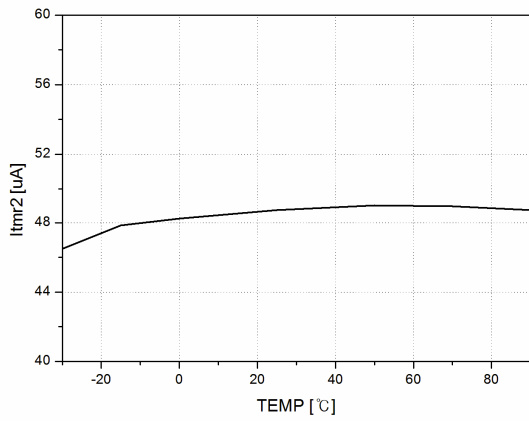

Figure 35. TIMER Current 2 vs. Temperature



Functional Description

UVLO: The under-voltage lockout (UVLO) circuit guarantees the stable operation of the IC's control circuit by stopping and starting it as a function of the V_{IN} value. The UVLO circuit turns on the control circuit when V_{IN} exceeds 5.2V. When V_{IN} is lower than 4.75V, the IC startup current is less than 100 μ A.

ENA: Applying voltage higher than 1.3V to the ENA pin enables the IC. Applying voltage lower than 0.7V to the ENA pin disables the IC. In terms of the protections, applying voltage higher than 2.5V to the ENA pin disables OLP and SLP. Applying voltage lower than 2.1V to the ENA pin enables the OLP and the SLP.

Main Oscillator: In normal mode, the external timing capacitor (CT) is charged by the current flowing from the reference voltage source, which is formed by the timing resistor (RT) and the timing capacitor (CT). The sawtooth waveform charges up to 2V. Once CT voltage reaches 2V, the CT begins discharging down to 0.45V. Next, the CT starts charging again and a new switching cycle begins, as shown in Figure 36. The main frequency is programmed by adjusting the RT and CT value. The main frequency is calculated as:

$$f_{osc} = \frac{1}{RT \cdot CT \cdot \ln\left(\frac{3.9585 \cdot RT - 13650}{2.61 \cdot RT - 13650}\right)} \text{ [Hz]} \quad (1)$$

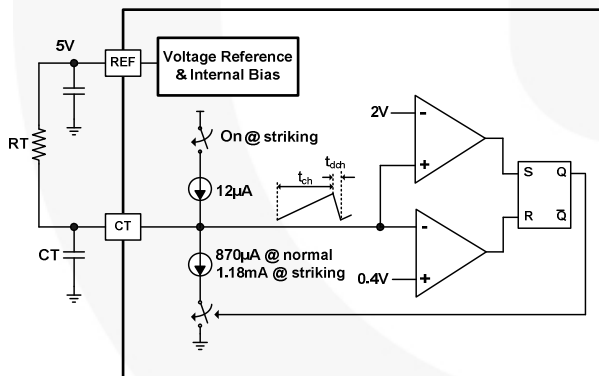

Figure 36. Main Oscillator Circuit

In striking mode, the external timing capacitor (CT) is charged by the current flowing from the reference voltage source and 12 μ A current source, which increases the frequency. If the product of RT and CT value is constant, the striking frequency is depending on CT and is calculated as:

$$f_{str} = \frac{1}{RT \cdot CT \cdot \ln\left(\frac{13.65 + (3I_1 - 4.55I_2)RT}{-I_1 \cdot I_2 \cdot RT^2} \cdot \frac{13.65 + (4.55I_1 - 3I_2)RT}{-I_1 \cdot I_2 \cdot RT^2}\right)} \text{ [Hz]} \quad (2)$$

$$\therefore I_1 = 12 \times 10^{-6} \text{ A}, I_2 = 1.128 \times 10^{-3} \text{ A}$$

Burst Dimming Oscillator: The burst dimming timing capacitor (BCT) is charged by the current flowing from the reference voltage source, which is formed by the burst dimming timing resistor (BRT) and the burst dimming timing capacitor (BCT). The sawtooth waveform charges up to 2V. Once the BCT voltage reaches 2V, the capacitor begins discharging down to 0.5V. Next, the BCT starts charging again and a new burst dimming cycle begins, as shown in Figure 37. The burst dimming frequency is programmed by adjusting the BCT and BRT values. The burst dimming frequency is calculated as:

$$f_{oscB} = \frac{1}{BRT \cdot BCT \cdot \ln\left(\frac{0.039 \cdot BRT - 4500}{0.026 \cdot BRT - 4500}\right)} \text{ [Hz]} \quad (3)$$

To avoid visible flicker, the burst dimming frequency should be greater than 120Hz.

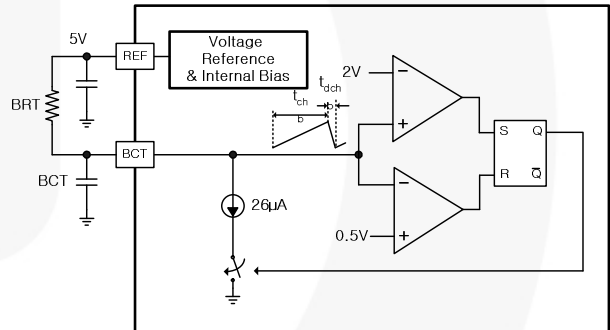

Figure 37. Burst Dimming Oscillator Circuit

Analog Dimming: For analog dimming, the lamp intensity is controlled with the external dimming signal (V_{ADIM}) and resistors. Figure 38 shows how to implement an analog dimming circuit.

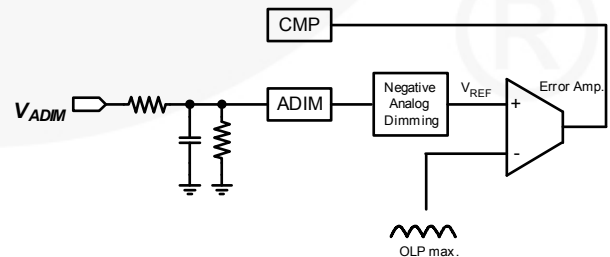

Figure 38. Analog Implementation Circuit

In full brightness, the maximum rms value of the lamp current is calculated as:

$$i_{rms}^{max} = V_{ref_max} \frac{\pi}{2\sqrt{2}R_{S1}} [A] \quad (4)$$

The lamp intensity is inversely proportional to V_{ADIM} . As V_{ADIM} increases, the lamp intensity decreases and the rms value of the lamp current is calculated as:

$$i_{rms}^{max} = V_{ref} \frac{\pi}{2\sqrt{2}R_s} [A] \quad (5)$$

$$V_{ref} = V_{ref_max} - 0.30V_{ADIM} [A]$$

Figure 39 shows the lamp current waveform vs. V_{ADIM} in an analog dimming mode.

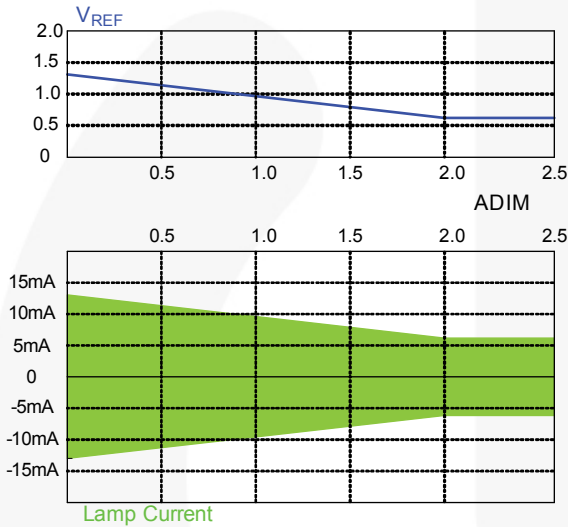

Figure 39. Analog Dimming Waveforms

Burst Dimming: Lamp intensity is controlled with the BDIM signal over a wide range. When BDIM voltage is lower than BCT voltage, the lamp current is turned on; 0V on BDIM commands full brightness. The duty cycle of the PWM pulse determines the lamp brightness. The lamp intensity is inversely proportional to BDIM voltage. As BDIM voltage increases, the lamp intensity decreases. Figure 40 shows the lamp current waveform vs. DIM in negative burst dimming mode.

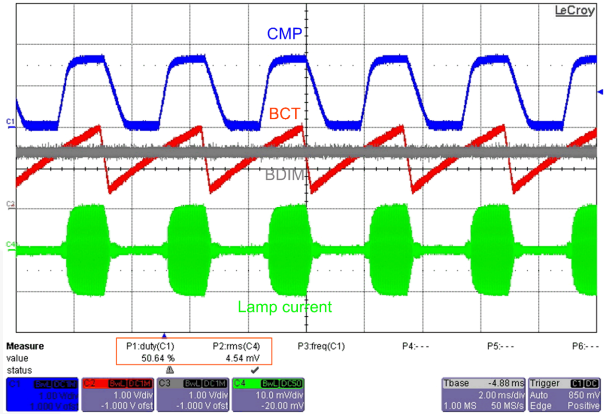

Figure 40. Burst Dimming Waveforms

Burst dimming can be implemented, not only DC voltage, but also using PWM pulse as the BDIM signal. Figure 41 shows how to implement burst dimming using PWM pulse as BDIM signal.

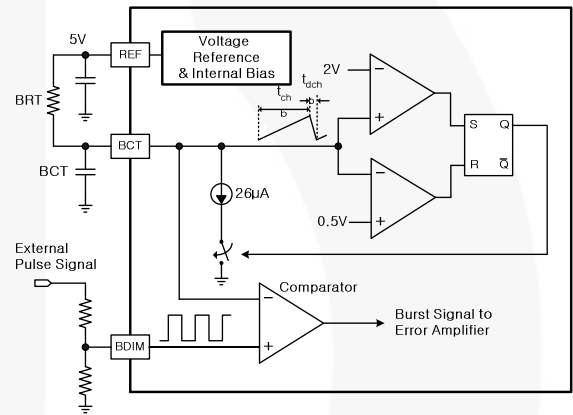

Figure 41. Burst Dimming Implementation Circuit Using an External Pulse

Figure 42 shows the lamp current waveform vs. an external pulse in negative burst dimming mode.

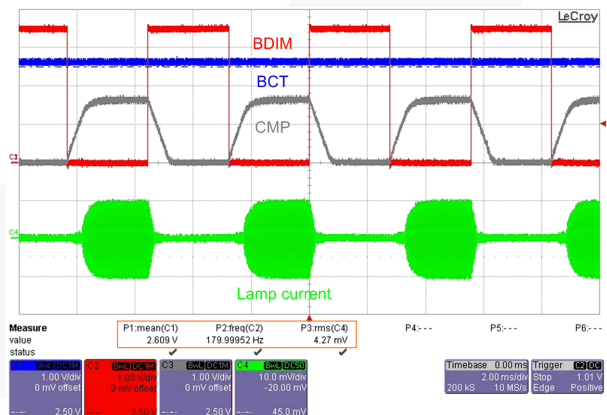

Figure 42. Burst Dimming Waveform Using an External Pulse

During striking mode, burst dimming operation is disabled to guarantee continuous striking time. Figure 43 shows burst dimming disabled during striking mode.

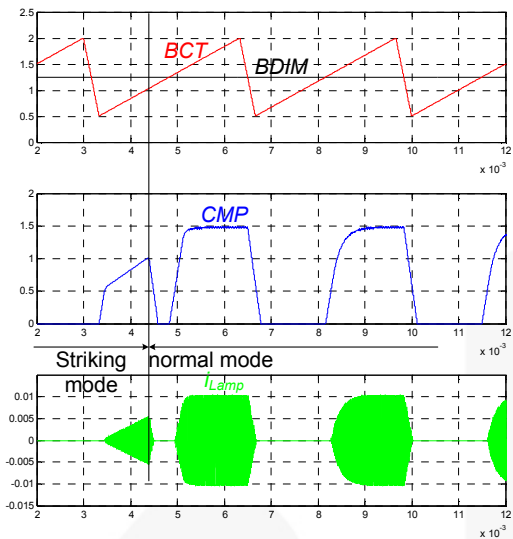

Figure 43. Burst Dimming During Striking Mode

Soft-Start: A soft-start circuit ensures a gradual increase in the input and output power. FAN7318 has no soft-start pin, but provides soft-start function using the second BCT waveform. The second BCT waveform limits CMP voltage at initial operation, so lamp current increases gradually.

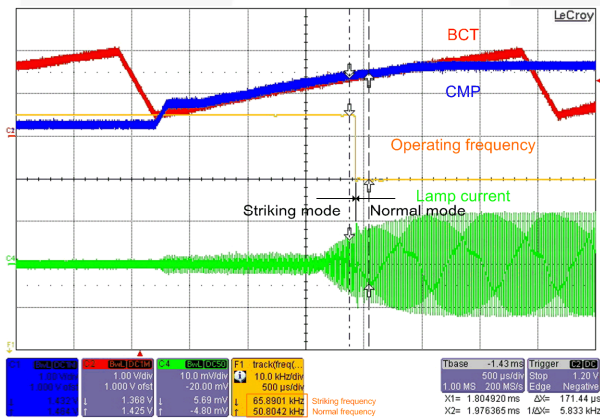

Figure 44. Soft-Start in Normal Mode

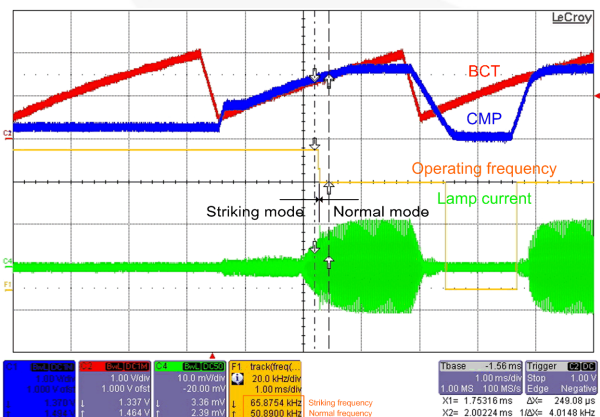

Figure 45. Soft-Start in Burst Dimming Mode

Output Drives: FAN7318 is designed to drive P-N half-bridge MOSFETs with symmetric duty cycle. FAN7318 can drive P-MOSFET directly without a level-shift capacitor and a Zener diode. A fixed dead time of 500ns is introduced between two outputs at maximum duty cycle, as shown in Figure 46.

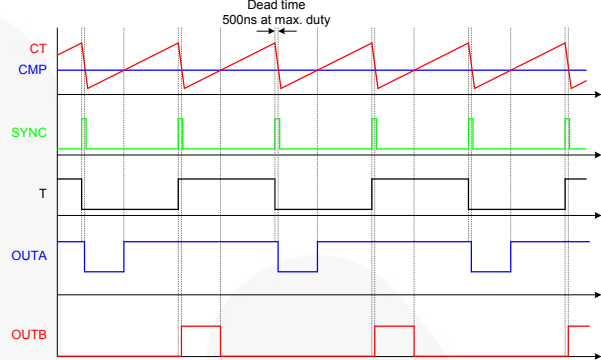

Figure 46. MOSFETs Gate Drive Signal

Lamp Current Feedback Circuit: FAN7318 has four OLP pins for lamp current feedback and protections. The inputs of four OLP pins are connected to the internal half-wave and full-wave rectifier circuits. The half-wave rectified signals of four OLP inputs are connected to the maximum detector circuit. The full-wave rectified signals of four OLP inputs are connected to the minimum detector circuit.

The two inputs among the inputs of four OLP pins should be inverse phase with the other two inputs. If not, FB-High protection may be triggered.

Lamp Voltage Feedback Circuit: FAN7318 has four OLR pins for lamp voltage feedback and protections. The inputs of four OLR pins are connected to the internal full-wave rectifier circuit. The full-wave rectified signals of four OLR inputs are connected to the maximum detector circuit for lamp voltage feedback and protections. Furthermore, they are connected to the minimum detector circuit for protections.

Protections: The FAN7318 provides the following latch-mode protections: Open-Lamp Regulation (OLR), Open-Lamp Protection (OLP), Short-Lamp Protection (SLP), CMP-High Protection, FB-High Protection, and Thermal Shutdown (TSD). The latch is reset when V_{IN} falls to the UVLO voltage or ENA is pulled down to GND.

The protection delay time can be adjusted by a capacitor between the TIMER pin and GND.

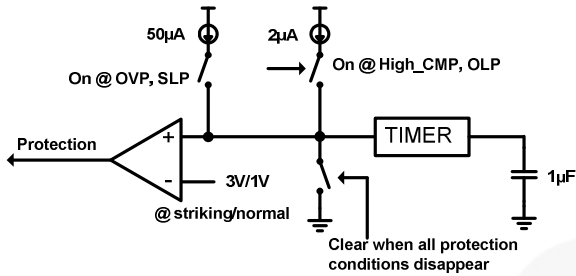

Figure 47. Protection Timing Delay

Assume that the TIMER pin capacitor is 1µF.

The striking time is calculated as:

$$t_{strike} = \frac{C\Delta V_{str}}{I_{sur1}} = \frac{1\mu F \cdot 3V}{2\mu A} = 1.5s \quad (6)$$

The OVP and SLP delay time are calculated as:

$$t_{OVP_SLP} = \frac{C\Delta V_{nor}}{I_{sur2}} = \frac{1\mu F \cdot 1V}{50\mu A} = 20ms \quad (7)$$

The CMP high protection and OLP delay time are calculated as:

$$t_{OLP_CMPH} = \frac{C\Delta V_{nor}}{I_{sur1}} = \frac{1\mu F \cdot 1V}{2\mu A} = 500ms \quad (8)$$

Open-Lamp Regulation: When the maximum of the rectified OLR input voltages (V_{OLR}^{max}) is more than 2V, the IC enters regulation mode and controls CMP voltage. The IC limits the lamp voltage by decreasing CMP source current. If V_{OLR}^{max} is between 1.34V and 2V, CMP source current decreases to 3.2µA. Then, if V_{OLR}^{max} reaches 2V, CMP source current decreases to 0µA, so the CMP voltage remains constant and the lamp voltage also remains constant, as shown in Figure 48.

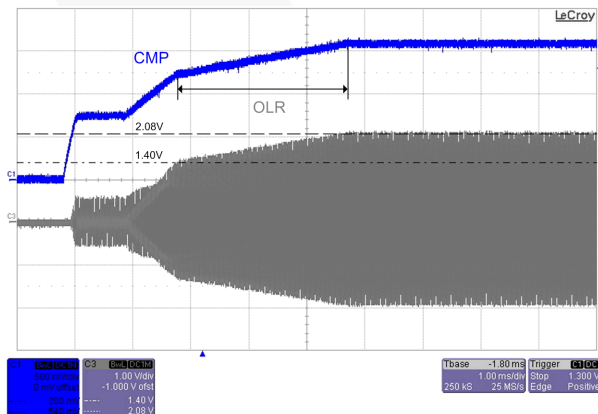

Figure 48. Open-Lamp Regulation in Striking Mode

Finally, if V_{OLR}^{max} is more than 2.2V, the error amplifier for OLR is operating and CMP sink current increases, so CMP voltage decreases and the lamp voltage maintains the determined value, as shown in Figure 49.

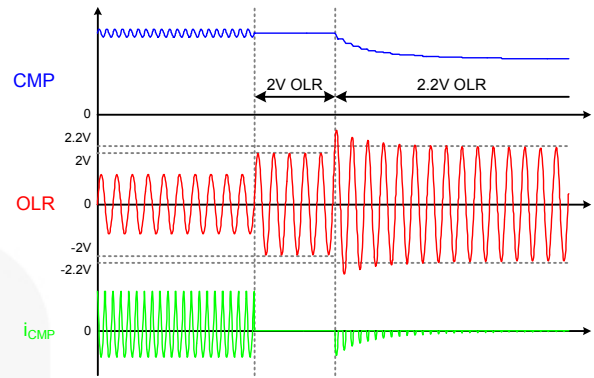

Figure 49. 2.2V Open-Lamp Regulation

Over-Voltage Protection: In normal mode, while V_{OLR}^{max} is higher than 1.34V, the TIMER pin capacitor is charged by an internal current source of 50µA. Once the TIMER reaches 1V, the IC enters shutdown, as shown in Figure 50. This protection is disabled in striking mode to ignite lamps reliably.

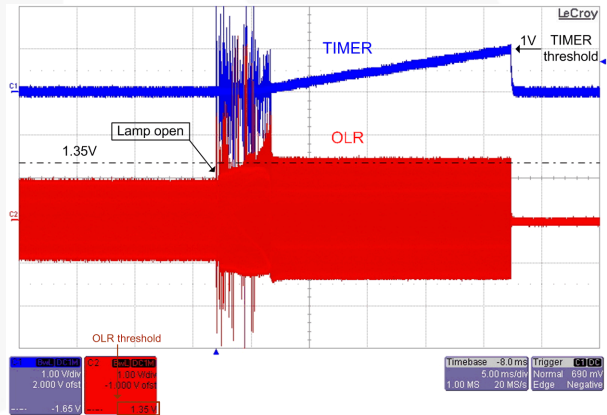

Figure 50. Over-Voltage Protection in Normal Mode

In burst dimming mode, while V_{OLR}^{max} is higher than 1.34V, burst dimming is disabled, so that the TIMER pin capacitor is charged continuously by an internal current source of 50µA. Once the TIMER reaches 1V, the IC enters shutdown, as shown in Figure 51.

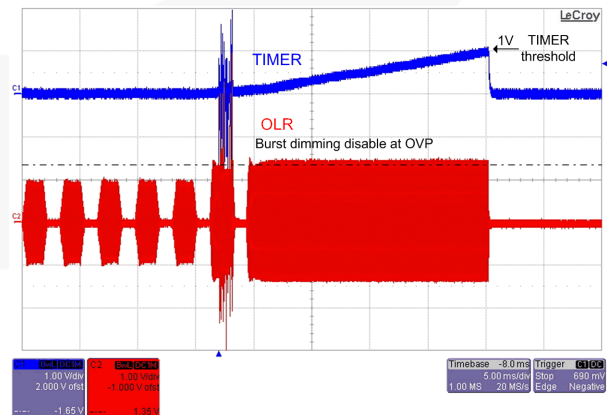

Figure 51. Over-Voltage Protection in Burst Dimming Mode

Open-Lamp Protection: If the minimum of the rectified OLP voltages (V_{OLP}^{min}) is less than 0.7V during initial operation, the IC operates in striking mode for a time predetermined by the TIMER pin capacitor and an internal current source, 2 μ A, as shown in Figure 52.

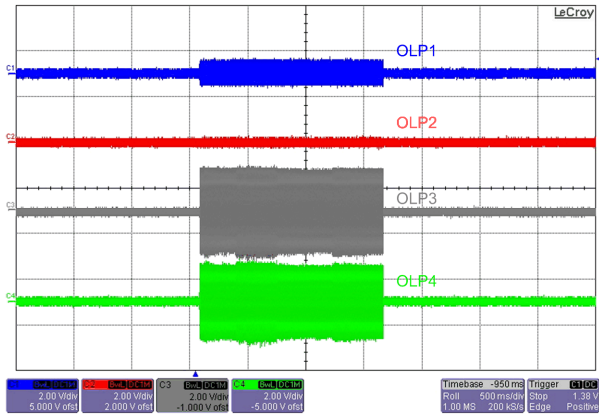

Figure 52. Open-Lamp Protection in Striking Mode

The IC starts operating in striking mode and remains in striking mode until four pulses of V_{OLP}^{min} higher than 0.7V occur. If more than four pulses, the IC changes from striking mode into normal mode, as shown in Figure 53.

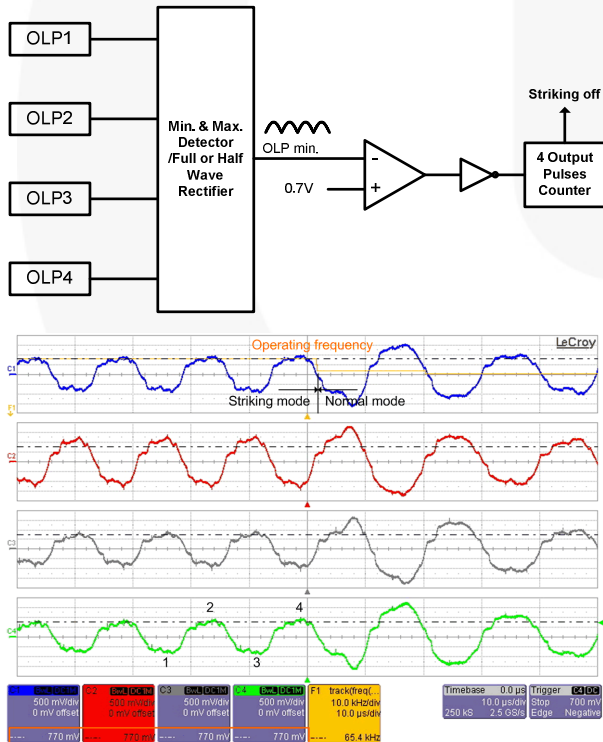

Figure 53. Mode Change from Striking to Normal

After ignition, if V_{OLP}^{min} is less than 0.5V for a time predetermined by the TIMER pin capacitor and an internal current source, 2 μ A in normal mode, the IC is shut down, as shown in Figure 54.

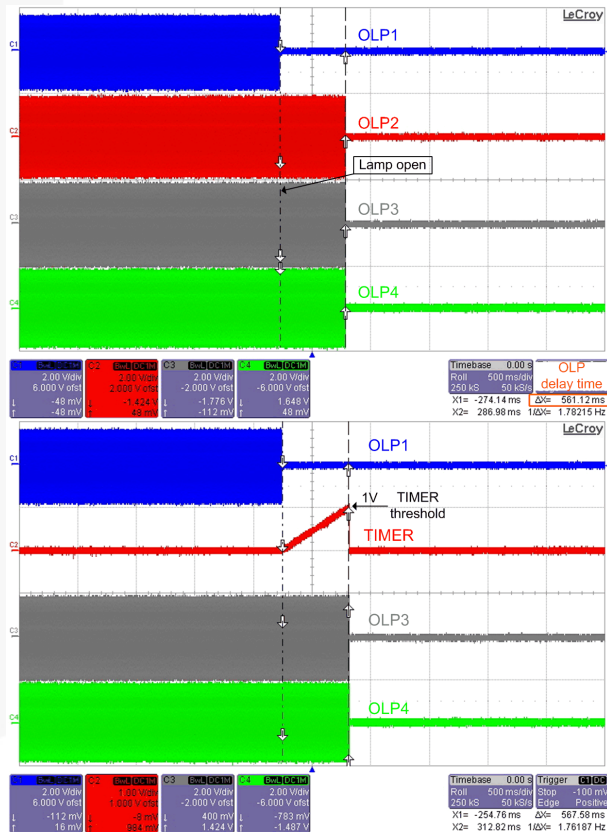
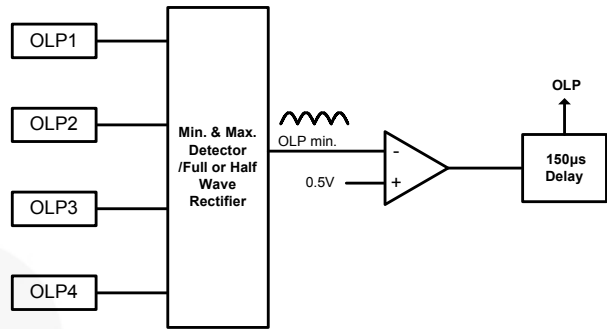

Figure 54. Open-Lamp Protection in Normal Mode

In burst dimming mode, if V_{OLP}^{min} is less than 0.5V for another time predetermined by the TIMER pin capacitor and an internal current source, 2 μ A, the IC is shut down, as shown in Figure 55. The open-lamp protection delay in burst dimming mode is shorter than in full-brightness because short-lamp condition is detected at rising interval of lamp voltage in burst dimming, then another internal current source is turned on during the interval.

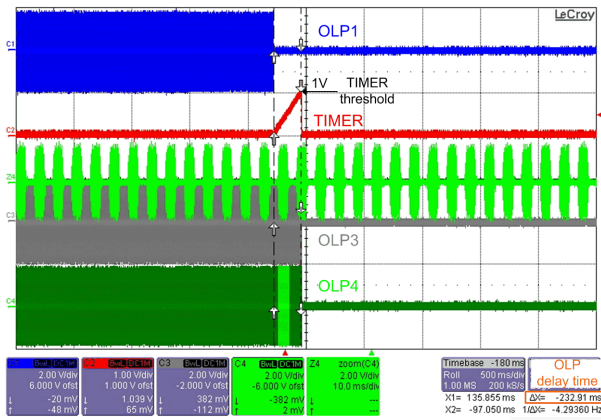

Figure 55. Open-Lamp Protection in Burst Dimming Mode

Applying voltage lower than 2.1V to the ENA pin enables OLP. Applying voltage higher than 2.5V to the ENA pin disables OLP and is called as DCR mode. Regardless of DCR mode, OLP is enabled in striking mode.

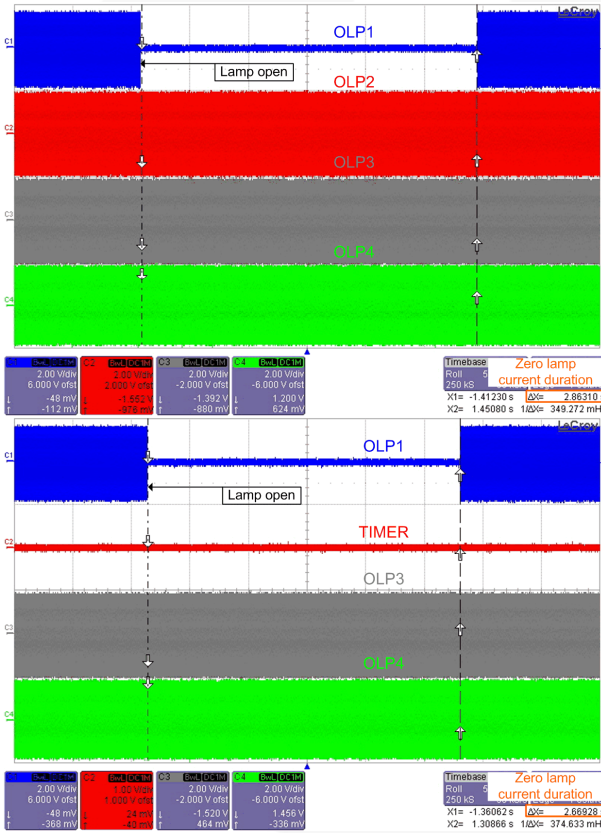

Figure 56. Open-Lamp Protection Disable in DCR Mode

Short-Lamp Protection: If the minimum of the rectified OLR voltages (V_{OLR}^{min}) is less than 0.3V for a time predetermined by the TIMER pin capacitor and a internal current source of 50 μ A in normal mode, the IC is shut down, as shown in Figure 57. This protection is disabled in striking mode to ignite lamps reliably.

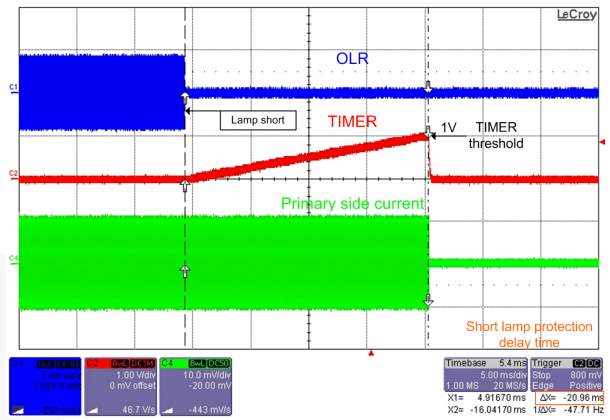

Figure 57. Short-Lamp Protection in Normal Mode

In burst dimming mode, if V_{OLR}^{min} is less than 0.3V for a time predetermined by the TIMER pin capacitor and a internal current source of 50 μ A turned on only burst dimming on time, the IC is shut down, as shown in Figure 58. SLP protection delay time changes, depending on burst dimming on duty ratio.

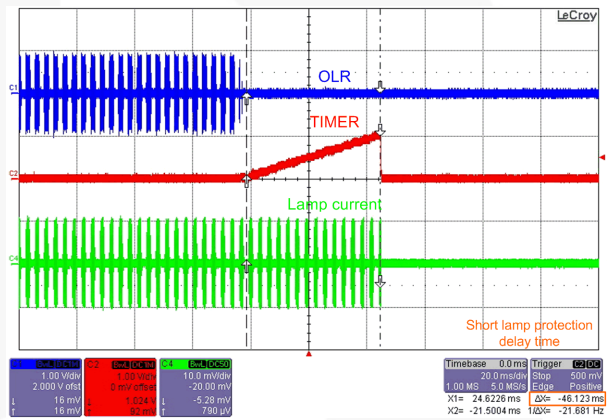

Figure 58. Short-Lamp Protection in Burst Dimming Mode

Applying voltage higher than 2.5V to the ENA pin disables SLP. Applying voltage lower than 2.1V to the ENA pin enables SLP.

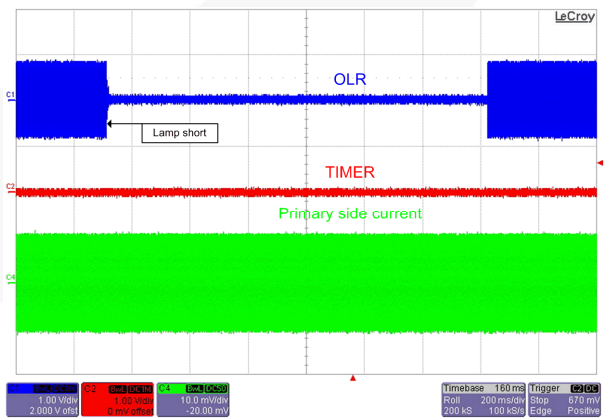

Figure 59. Short-Lamp Protection Disable in DCR Mode

CMP-High Protection: If CMP is more than 3.5V for a time predetermined by the TIMER pin capacitor and an internal current source of 50 μ A in normal mode, the IC is shut down, as shown in Figure 60.

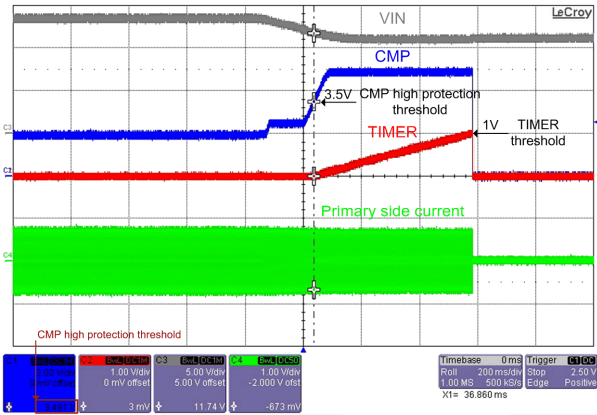

Figure 60. CMP-High Protection

This protection is disabled by a pull-down resistor (a few M Ω) between CMP and GND. If CMP voltage reaches 2.5V, CMP source current decreases to 2 μ A. Determine a pull down resistor value such that the whole of this current can flow through the resistor. If so, CMP-High protection can be disabled, as shown Figure 61. This protection is disabled in striking mode to ignite the lamps reliably.

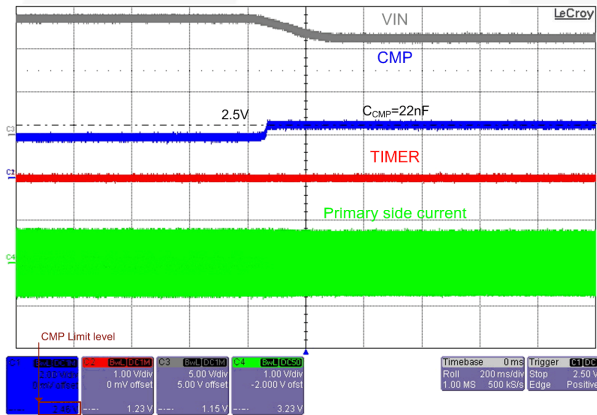

Figure 61. CMP-High Protection Disabled by a Pull-Down Resistor

High-FB Protection: If the minimum of the rectified OLP voltages (V_{OLP}^{max}) is more than 3.5V, the counter starts counting eight rectified OLP pulses in normal mode, then the IC enters shutdown, as shown in Figure 62. This counter is reset by detecting the positive edge of BCT. This protection is disabled in striking mode to ignite the lamps reliably.

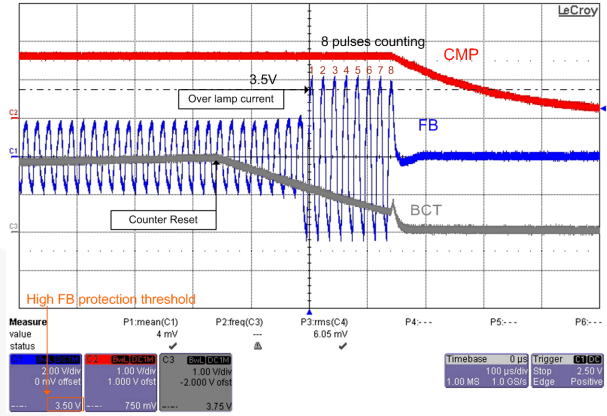

Figure 62. FB-High Protection

Thermal Shutdown: The IC provides the function to detect the abnormal over-temperature. If the IC temperature exceeds approximately 150 $^{\circ}$ C, the thermal shutdown triggers.

Typical Application Circuit (LCD Backlight Inverter)

Application	Device	Input Voltage Range	Number of Lamps
22-Inch LCD Monitor	FAN7318	15V±10%	4

1. Features

- High-Efficiency Single-Stage Power Conversion
- P-N Half-Bridge Topology
- Reduces Required External Components
- Enhanced System Reliability through Protection Functions

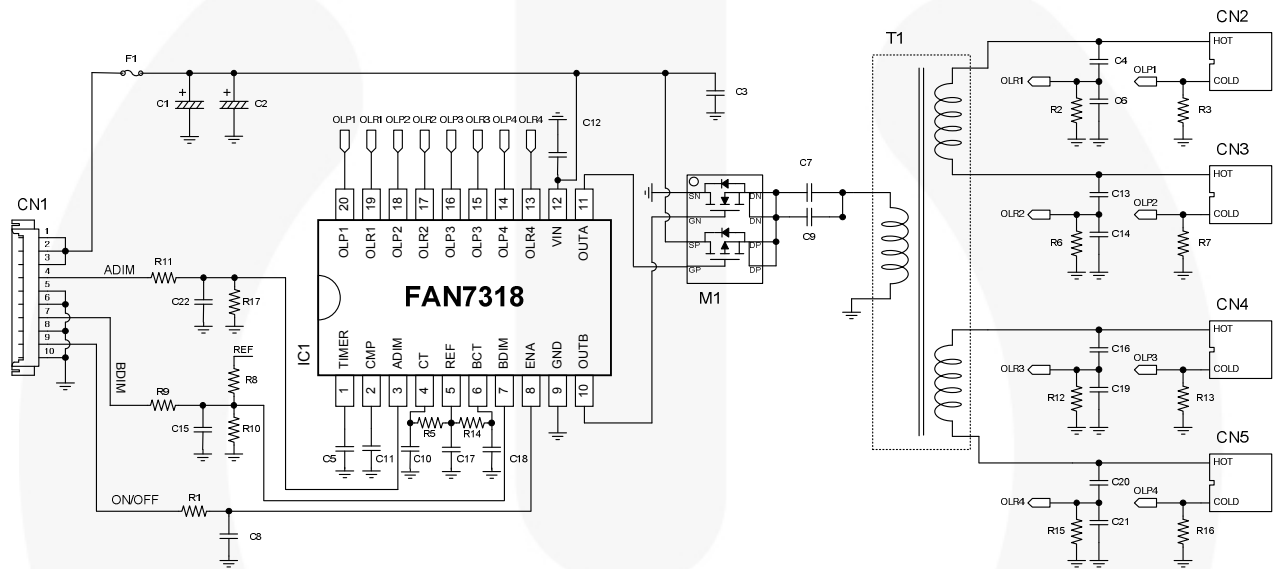

Figure 63. Typical Application Circuit

Physical Dimensions

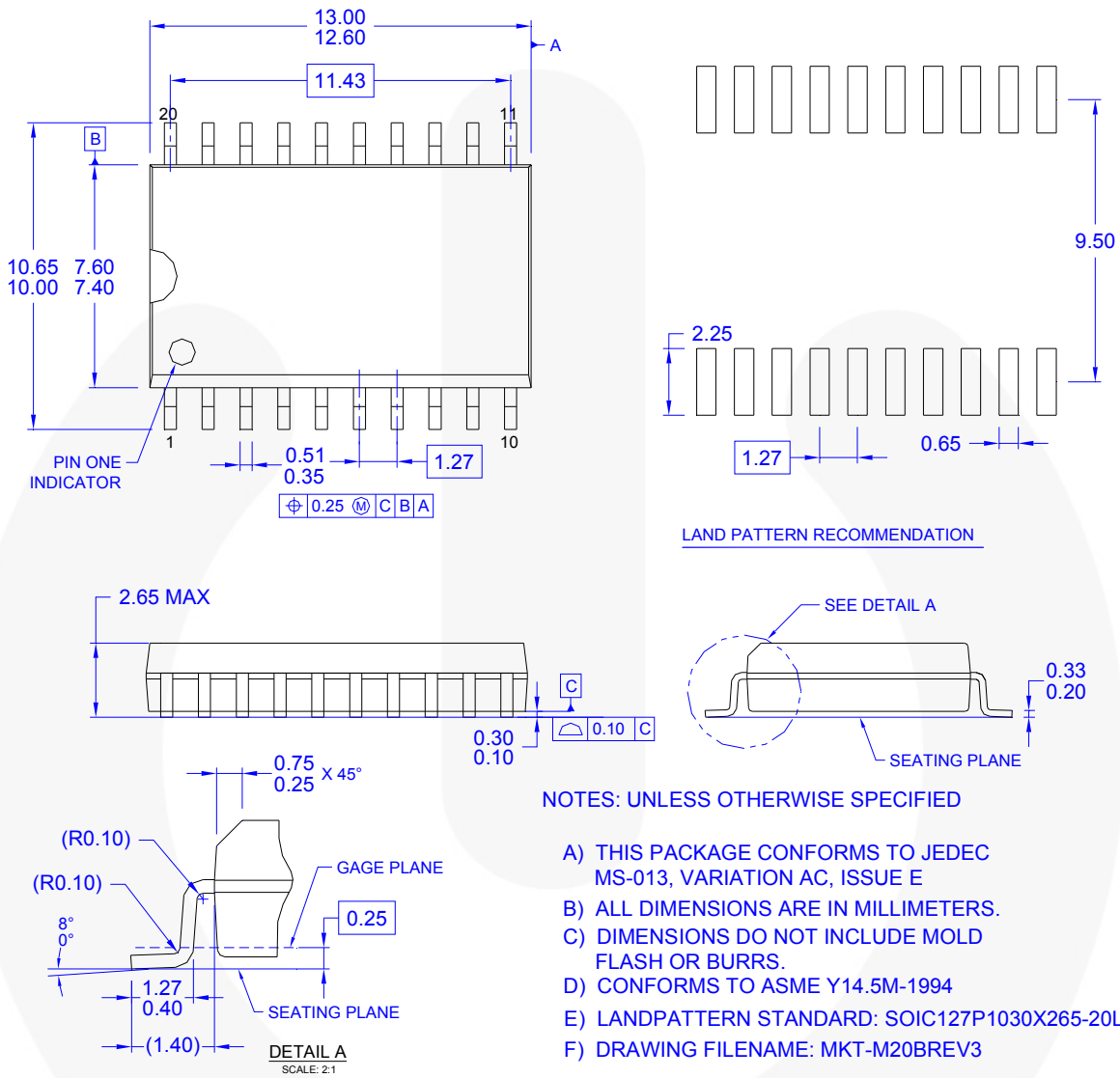

Figure 64. 20-Lead, Small Outline Integrated Circuit (SOIC) Package





Package drawings are provided as a service to customers considering Fairchild components. Drawings may change in any manner without notice. Please note the revision and/or date on the drawing and contact a Fairchild Semiconductor representative to verify or obtain the most recent revision. Package specifications do not expand the terms of Fairchild's worldwide terms and conditions, specifically the warranty therein, which covers Fairchild products.

Always visit Fairchild Semiconductor's online packaging area for the most recent package drawings:
<http://www.fairchildsemi.com/packaging/>.



TRADEMARKS

The following includes registered and unregistered trademarks and service marks, owned by Fairchild Semiconductor and/or its global subsidiaries, and is not intended to be an exhaustive list of all such trademarks.

- | | | | |
|--------------------------|---|---|---|
| AccuPower™ | FPS™ | Power-SPM™ | The Power Franchise® |
| Auto-SPM™ | F-PFS™ | PowerTrench® | The Right Technology for Your Success™ |
| AX-CAP™ | FRFET® | PowerXS™ | the power franchise |
| BitSiC® | Global Power Resource SM | Programmable Active Droop™ | TinyBoost™ |
| Build it Now™ | Green FPST™ | QFET® | TinyBuck™ |
| CorePLUSTM | Green FPST™ e-Series™ | QST™ | TinyCalc™ |
| CorePOWER™ | Gmax™ | Quiet Series™ | TinyLogic® |
| CROSSVOLT™ | GTO™ | RapidConfigure™ | TINYOPTO™ |
| CTL™ | IntelliMAX™ |  | TinyPower™ |
| Current Transfer Logic™ | ISOPLANAR™ | Saving our world, 1mW/W/KW at a time™ | TinyPWM™ |
| DEUXPEED® | MegaBuck™ | SignalWise™ | TinyWire™ |
| Dual Cool™ | MICROCOUPLER™ | SmartMax™ | TranSiC® |
| EcoSPARK® | MicroFET™ | SMART START™ | TriFault Detect™ |
| EfficientMax™ | MicroPak™ | SPM® | TRUECURRENT® |
| ESBC™ | MicroPak2™ | STEALTH™ | µSerDes™ |
| F ® | MillerDrive™ | SuperFET® |  |
| Fairchild® | MotionMax™ | SuperSOT™.3 | UHC® |
| Fairchild Semiconductor® | Motion-SPM™ | SuperSOT™.6 | Ultra FRFET™ |
| FACT Quiet Series™ | mWSaver™ | SuperSOT™.8 | UniFET™ |
| FACT® | OptoHIT™ | SupreMOS® | VCX™ |
| FAST® | OPTOLOGIC® | SyncFET™ | VisualMax™ |
| FastvCore™ | OPTOPLANAR® | Sync-Lock™ | XST™ |
| FETBench™ |  |  | |
| FlashWriter® | PDP SPM™ | | |

* Trademarks of System General Corporation, used under license by Fairchild Semiconductor.

DISCLAIMER

FAIRCHILD SEMICONDUCTOR RESERVES THE RIGHT TO MAKE CHANGES WITHOUT FURTHER NOTICE TO ANY PRODUCTS HEREIN TO IMPROVE RELIABILITY, FUNCTION, OR DESIGN. FAIRCHILD DOES NOT ASSUME ANY LIABILITY ARISING OUT OF THE APPLICATION OR USE OF ANY PRODUCT OR CIRCUIT DESCRIBED HEREIN; NEITHER DOES IT CONVEY ANY LICENSE UNDER ITS PATENT RIGHTS, NOR THE RIGHTS OF OTHERS. THESE SPECIFICATIONS DO NOT EXPAND THE TERMS OF FAIRCHILD'S WORLDWIDE TERMS AND CONDITIONS, SPECIFICALLY THE WARRANTY THEREIN, WHICH COVERS THESE PRODUCTS.

LIFE SUPPORT POLICY

FAIRCHILD'S PRODUCTS ARE NOT AUTHORIZED FOR USE AS CRITICAL COMPONENTS IN LIFE SUPPORT DEVICES OR SYSTEMS WITHOUT THE EXPRESS WRITTEN APPROVAL OF FAIRCHILD SEMICONDUCTOR CORPORATION.

As used herein:

- Life support devices or systems are devices or systems which, (a) are intended for surgical implant into the body or (b) support or sustain life, and (c) whose failure to perform when properly used in accordance with instructions for use provided in the labeling, can be reasonably expected to result in a significant injury of the user.
- A critical component in any component of a life support, device, or system whose failure to perform can be reasonably expected to cause the failure of the life support device or system, or to affect its safety or effectiveness.

ANTI-COUNTERFEITING POLICY

Fairchild Semiconductor Corporation's Anti-Counterfeiting Policy. Fairchild's Anti-Counterfeiting Policy is also stated on our external website, www.fairchildsemi.com, under Sales Support.

Counterfeiting of semiconductor parts is a growing problem in the industry. All manufacturers of semiconductor products are experiencing counterfeiting of their parts. Customers who inadvertently purchase counterfeit parts experience many problems such as loss of brand reputation, substandard performance, failed applications, and increased cost of production and manufacturing delays. Fairchild is taking strong measures to protect ourselves and our customers from the proliferation of counterfeit parts. Fairchild strongly encourages customers to purchase Fairchild parts either directly from Fairchild or from Authorized Fairchild Distributors who are listed by country on our web page cited above. Products customers buy either from Fairchild directly or from Authorized Fairchild Distributors are genuine parts, have full traceability, meet Fairchild's quality standards for handling and storage and provide access to Fairchild's full range of up-to-date technical and product information. Fairchild and our Authorized Distributors will stand behind all warranties and will appropriately address any warranty issues that may arise. Fairchild will not provide any warranty coverage or other assistance for parts bought from Unauthorized Sources. Fairchild is committed to combat this global problem and encourage our customers to do their part in stopping this practice by buying direct or from authorized distributors.

PRODUCT STATUS DEFINITIONS

Definition of Terms

Datasheet Identification	Product Status	Definition
Advance Information	Formative / In Design	Datasheet contains the design specifications for product development. Specifications may change in any manner without notice.
Preliminary	First Production	Datasheet contains preliminary data; supplementary data will be published at a later date. Fairchild Semiconductor reserves the right to make changes at any time without notice to improve design.
No Identification Needed	Full Production	Datasheet contains final specifications. Fairchild Semiconductor reserves the right to make changes at any time without notice to improve the design.
Obsolete	Not In Production	Datasheet contains specifications on a product that is discontinued by Fairchild Semiconductor. The datasheet is for reference information only.

Rev. I54

