



February 2016

FAN5361 6 MHz, 600 mA / 750 mA Synchronous Buck Regulator

Features

- 6 MHz Fixed-Frequency Operation
- 35 μ A Typical Quiescent Current
- Best-in-Class Load Transient Response
- Best-in-Class Efficiency
- 600 mA or 750 mA Output Current Capability
- 2.3 V to 5.5 V Input Voltage Range
- 1.0 to 1.90 V Fixed Output Voltage
- Low Ripple Light-Load PFM Mode
- Forced PWM and External Clock Synchronization
- Internal Soft-Start
- Input Under-Voltage Lockout (UVLO)
- Thermal Shutdown and Overload Protection
- 6-bump WLCSP, 0.4 mm Pitch
- 6-pin 2 x 2 mm UMLP

Applications

- Cell Phones, Smart Phones
- Tablets, Netbooks[®], Ultra-Mobile PCs
- 3G, LTE, WiMAX[™], WiBro[®], and WiFi[®] Data Cards
- Gaming Devices, Digital CamerasDC/DC Micro Modules

Description

The FAN5361 is a 600 mA or 750 mA, step-down, switching voltage regulator that delivers a fixed output from a 2.3 V to 5.5 V input voltage supply. Using a proprietary architecture with synchronous rectification, the FAN5361 is capable of delivering a peak efficiency of 92%, while maintaining efficiency over 80% at load currents as low as 1 mA.

The regulator operates at a nominal fixed frequency of 6 MHz, which reduces the value of the external components to 470 nH for the output inductor and 4.7 μ F for the output capacitor. The PWM modulator can be synchronized to an external frequency source.

At moderate and light loads, pulse frequency modulation is used to operate the device in power-save mode with a typical quiescent current of 35 μ A. Even with such a low quiescent current, the part exhibits excellent transient response during large load swings. At higher loads, the system automatically switches to fixed-frequency control, operating at 6 MHz. In shutdown mode, the supply current drops below 1 μ A, reducing power consumption. For applications that require minimum ripple or fixed frequency, PFM mode can be disabled using the MODE pin.

The FAN5361 is available in 6-bump, 0.4 mm pitch, Wafer-Level Chip-Scale Package (WLCSP) and a 6-lead 2 x 2 mm ultra-thin MLP package (UMLP).

Typical Applications

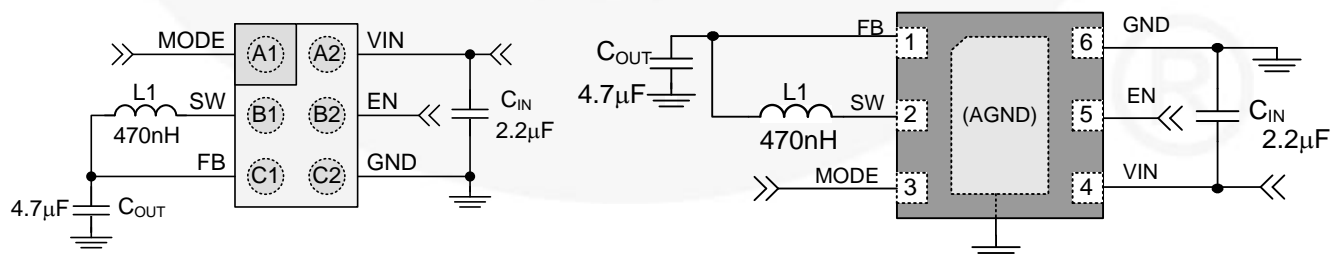

Figure 1. Typical Applications

All trademarks are the property of their respective owners.

Ordering Information

Part Number	Output Voltage ⁽¹⁾	Package	Temperature Range	Packing
FAN5361UC123X	1.233 V	WLCSP-6, 0.4 mm Pitch	-40 to +85°C	Tape and Reel
FAN5361UC182X	1.820 V			
FAN5361UC19X	1.900 V			
FAN5361UMP123X	1.233 V	6-Lead, 2 x 2 mm UMLP		
FAN5361UMP15X	1.500 V			
FAN5361UMP182X	1.820 V			

Note:

- Other voltage options available on request. Contact a Fairchild representative.

Pin Configurations

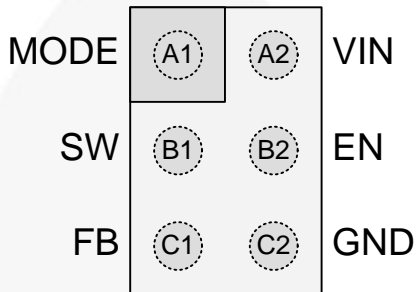

Figure 2. WLCSP, Bumps Facing Down

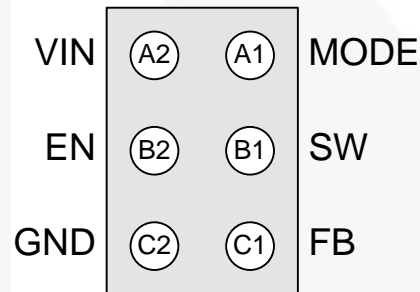

Figure 3. WLCSP, Bumps Facing Up

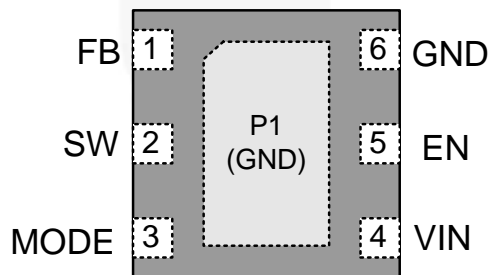

Figure 4. UMLP, Leads Facing Down

Pin Definitions

Pin #		Name	Description
WLCSP	UMLP		
A1	3	MODE	MODE. Logic 1 on this pin forces the IC to stay in PWM mode. A logic 0 allows the IC to automatically switch to PFM during light loads. The regulator also synchronizes its switching frequency to four times the frequency provided on this pin. Do not leave this pin floating. When tying HIGH, use at least 1kΩ series resistor if V_{IN} is expected to exceed 4.5 V.
B1	2	SW	Switching Node. Connect to output inductor.
C1	1	FB	Feedback / V_{OUT}. Connect to output voltage.
C2	6	GND	Ground. Power and IC ground. All signals are referenced to this pin.
B2	5	EN	Enable. The device is in shutdown mode when voltage to this pin is <0.4 V and enabled when >1.2 V. Do not leave this pin floating. When tying HIGH, use at least 1 kΩ series resistor if V_{IN} is expected to exceed 4.5 V.
A2	4	VIN	Input Voltage. Connect to input power source.

Absolute Maximum Ratings

Stresses exceeding the absolute maximum ratings may damage the device. The device may not function or be operable above the recommended operating conditions and stressing the parts to these levels is not recommended. In addition, extended exposure to stresses above the recommended operating conditions may affect device reliability. The absolute maximum ratings are stress ratings only.

Symbol	Parameter		Min.	Max.	Unit
V_{IN}	Input Voltage		-0.3	7.0	V
V_{SW}	Voltage on SW Pin		-0.3	$V_{IN} + 0.3^{(2)}$	V
V_{CTRL}	EN and MODE Pin Voltage		-0.3	$V_{IN} + 0.3^{(2)}$	V
	Other Pins		-0.3	$V_{IN} + 0.3^{(2)}$	V
ESD	Electrostatic Discharge Protection Level	Human Body Model per JESD22-A114	4.0		kV
		Charged Device Model per JESD22-C101	1.5		
T_J	Junction Temperature		-40	+150	°C
T_{STG}	Storage Temperature		-65	+150	°C
T_L	Lead Soldering Temperature, 10 Seconds			+260	°C

Note:

2. Lesser of 7 V or $V_{IN} + 0.3$ V.

Recommended Operating Conditions

The Recommended Operating Conditions table defines the conditions for actual device operation. Recommended operating conditions are specified to ensure optimal performance to the datasheet specifications. Fairchild does not recommend exceeding them or designing to Absolute Maximum Ratings.

Symbol	Parameter	Min.	Typ.	Max.	Unit
V_{CC}	Supply Voltage Range	2.3		5.5	V
I_{OUT}	Output Current	0		600	mA
L	Inductor		0.47		μH
C_{IN}	Input Capacitor		2.2		μF
C_{OUT}	Output Capacitor	1.6	4.7	12.0	μF
T_A	Operating Ambient Temperature	-40		+85	°C
T_J	Operating Junction Temperature	-40		+125	°C

Thermal Properties

Junction-to-ambient thermal resistance is a function of application and board layout. This data is measured with four-layer 1s2p boards in accordance to JEDEC standard JESD51. Special attention must be paid not to exceed junction temperature $T_{J(max)}$ at a given ambient temperature T_A .

Symbol	Parameter		Typical	Unit	
θ_{JA}	Junction-to-Ambient Thermal Resistance		WLCSP	150	°C/W
			UMLP	49	°C/W

Electrical Characteristics

Minimum and maximum values are at $V_{IN} = V_{EN} = 2.3V$ to $5.5V$, $V_{MODE} = 0V$ (AUTO Mode), $T_A = -40^\circ C$ to $+85^\circ C$; circuit of Figure 1, unless otherwise noted. Typical values are at $T_A = 25^\circ C$, $V_{IN} = V_{EN} = 3.6 V$.

Symbol	Parameter	Conditions	Min.	Typ.	Max.	Unit	
Power Supplies							
I_Q	Quiescent Current	No Load, Not Switching		35	55	μA	
		PWM Mode		6		mA	
$I_{(SD)}$	Shutdown Supply Current	$V_{IN} = 3.6 V$, EN = GND		0.05	1.00	μA	
V_{UVLO}	Under-Voltage Lockout Threshold	Rising V_{IN}		2.15	2.25	V	
V_{UVHYS}	Under-Voltage Lockout Hysteresis			150		mV	
Logic Inputs: EN and MODE Pins							
V_{IH}	Enable HIGH-Level Input Voltage		1.2			V	
V_{IL}	Enable LOW-Level Input Voltage				0.4	V	
V_{LHYS}	Logic Input Hysteresis Voltage			100		mV	
I_{IN}	Enable Input Leakage Current	Pin to V_{IN} or GND		0.01	1.00	μA	
Switching and Synchronization							
f_{SW}	Switching Frequency ⁽³⁾	$V_{IN} = 3.6 V$, $T_A = 25^\circ C$	5.4	6.0	6.6	MHz	
f_{SYNC}	MODE Synchronization Range ⁽³⁾	Square Wave at MODE Input	1.3	1.5	1.7	MHz	
Regulation							
V_O	Output Voltage Accuracy	1.900 V	$I_{LOAD} = 0$ to 750 mA ⁽⁴⁾	1.832	1.900	1.957	V
			PWM Mode ⁽⁴⁾	1.832	1.900	1.938	
		1.820 V	$I_{LOAD} = 0$ to 600 mA	1.784	1.820	1.875	
			PWM Mode	1.784	1.820	1.856	
		1.500 V	$I_{LOAD} = 0$ to 600 mA	1.470	1.500	1.545	
			PWM Mode	1.470	1.500	1.530	
1.233 V	$I_{LOAD} = 0$ to 600 mA	1.207	1.233	1.272			
	PWM Mode	1.207	1.233	1.259			
t_{SS}	Soft-Start	From EN Rising Edge		180	300	μs	
Output Driver							
$R_{DS(on)}$	PMOS On Resistance	$V_{IN} = V_{GS} = 3.6 V$		350		m Ω	
	NMOS On Resistance	$V_{IN} = V_{GS} = 3.6 V$		225			
$I_{LIM(OL)}$	PMOS Open-Loop Peak Current Limit ⁽⁵⁾	$V_{OUT} = 1.233 V, 1.5 V, 1.82 V$	900	1100	1250	mA	
		$V_{OUT} = 1.9 V$	1180	1375	1550		
T_{TSD}	Thermal Shutdown	CCM Only		150		$^\circ C$	
T_{HYS}	Thermal Shutdown Hysteresis			15		$^\circ C$	

Notes:

- Limited by the effect of t_{OFF} minimum (see Figure 14 and Figure 15 in Typical Performance Characteristics).
- Output voltage accuracy minimum: 1.862 V for V_{IN} 2.7 to 5.5 V on 1.9 V option.
- Refer to Operation Description and Typical Characteristics for closed-loop data.

Typical Performance Characteristics

Unless otherwise noted, $V_{IN} = V_{EN} = 3.6\text{ V}$, $V_{MODE} = 0\text{ V}$ (AUTO Mode), $V_{OUT} = 1.82\text{ V}$, $T_A = 25^\circ\text{C}$.

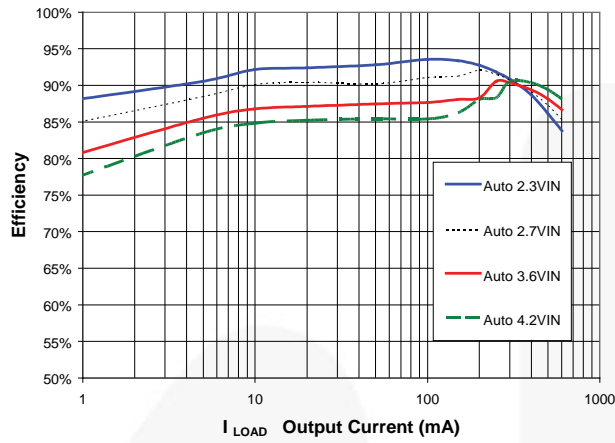

Figure 5. Efficiency vs. Load Current and Input Supply

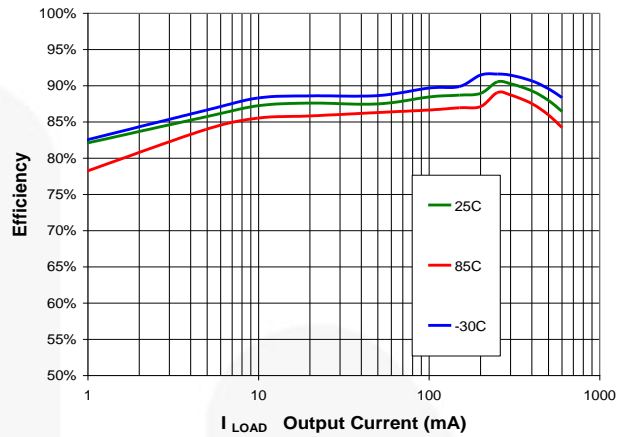

Figure 6. Efficiency vs. Load Current and Temperature

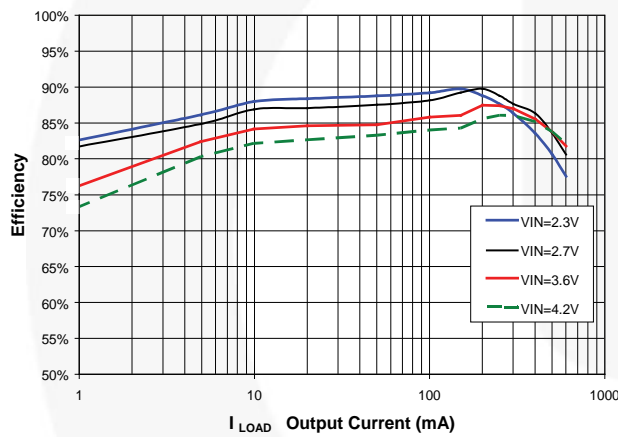

Figure 7. 1.233 V_{OUT} Efficiency vs. Load Current and Supply

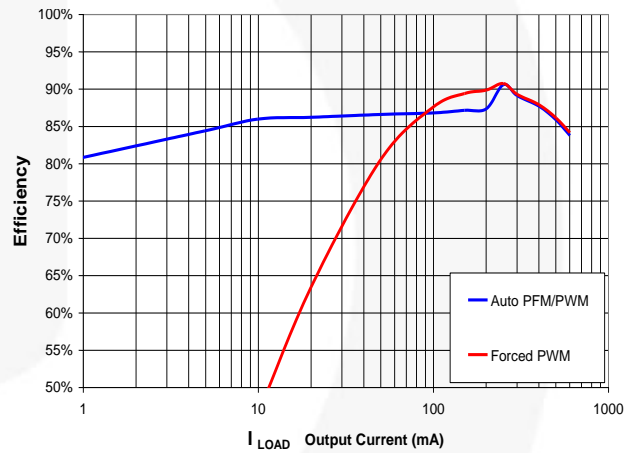

Figure 8. Efficiency, Auto PWM/PFM vs. Forced PWM

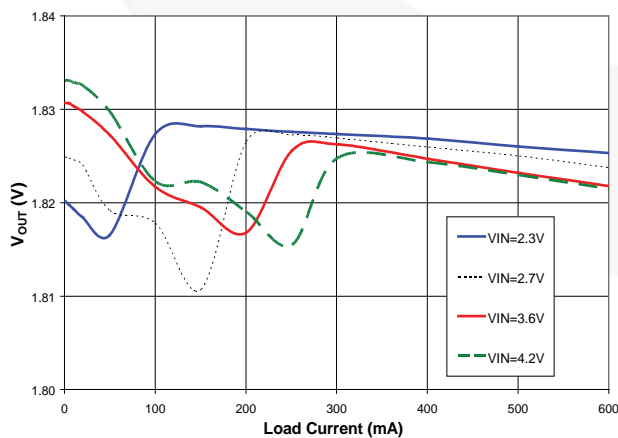

Figure 9. Load Regulation

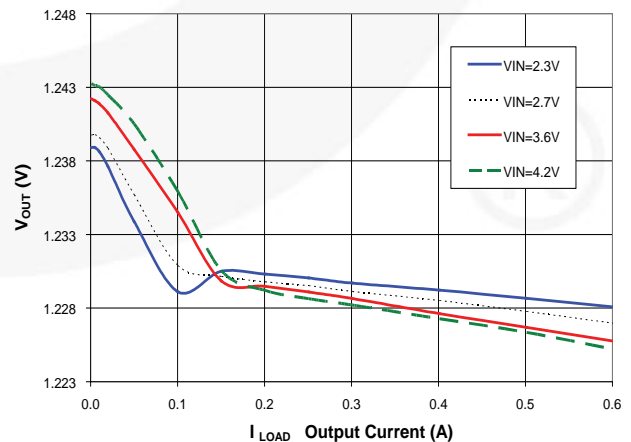

Figure 10. 1.233 V_{OUT} Load Regulation vs. Input Supply

Typical Performance Characteristics (Continued)

Unless otherwise noted, $V_{IN} = V_{EN} = 3.6\text{ V}$, $V_{MODE} = 0\text{ V}$ (AUTO Mode), $V_{OUT} = 1.82\text{ V}$, $T_A = 25^\circ\text{C}$.

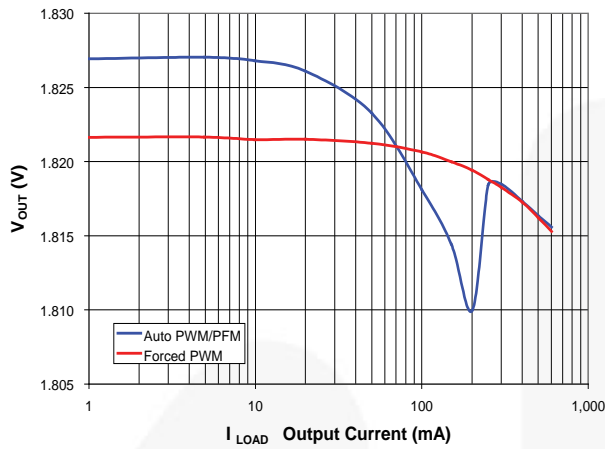

Figure 11. Load Regulation, Auto PFM / PWM and Forced PWM

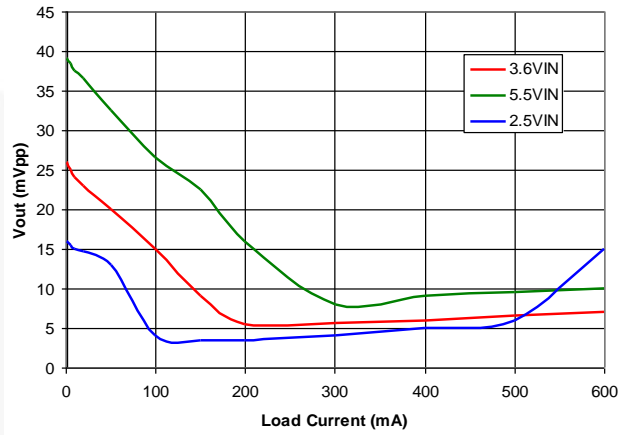

Figure 12. 1.82 V_{OUT} Peak-to-Peak Output Voltage Ripple

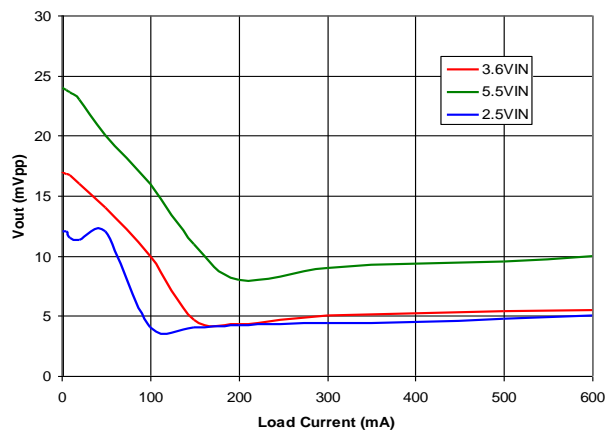

Figure 13. 1.233 V_{OUT} Peak-to-Peak Output Voltage Ripple

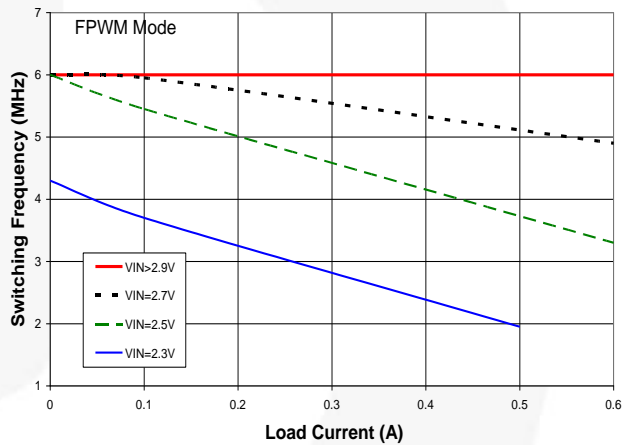

Figure 14. Effect of $t_{OFF(MIN)}$ on Reducing Switching Frequency

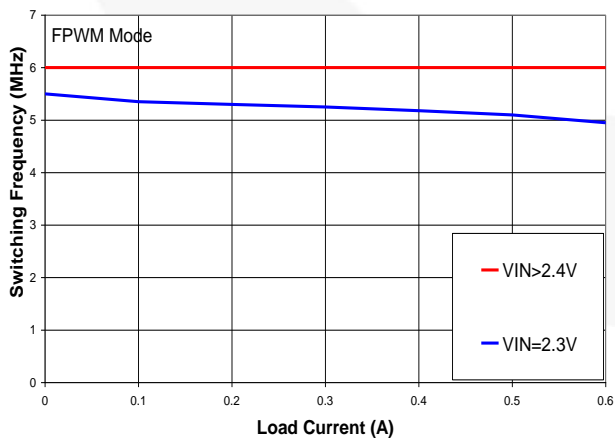

Figure 15. 1.233 V_{OUT} Effect of $t_{OFF(MIN)}$ on Reducing Switching Frequency

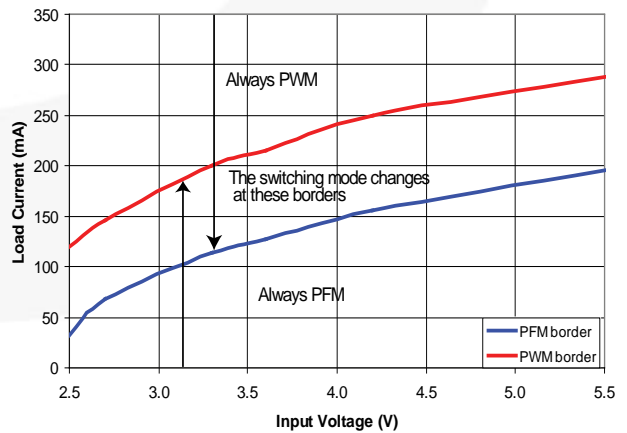

Figure 16. PFM / PWM Boundaries

Typical Performance Characteristics (Continued)

Unless otherwise noted, $V_{IN} = V_{EN} = 3.6\text{ V}$, $V_{MODE} = 0\text{ V}$ (AUTO Mode), $V_{OUT} = 1.82\text{ V}$, $T_A = 25^\circ\text{C}$.

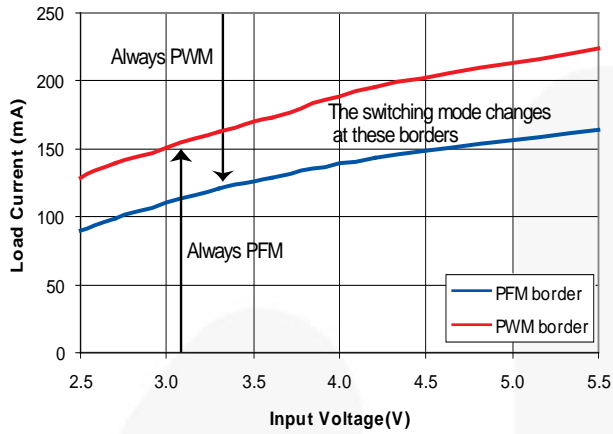

Figure 17. 1.233 V_{OUT} PFM / PWM Boundaries

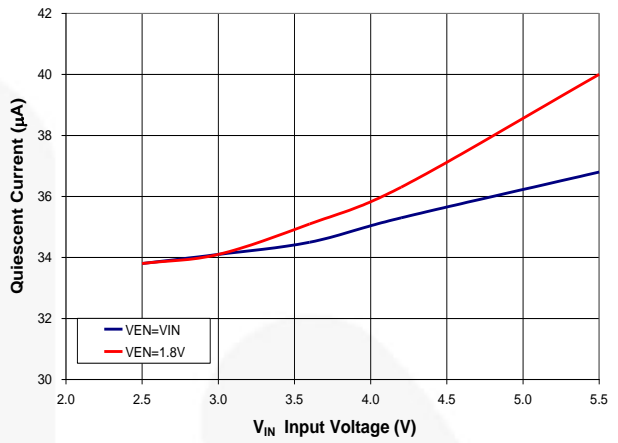

Figure 18. Quiescent Current vs. Input Voltage

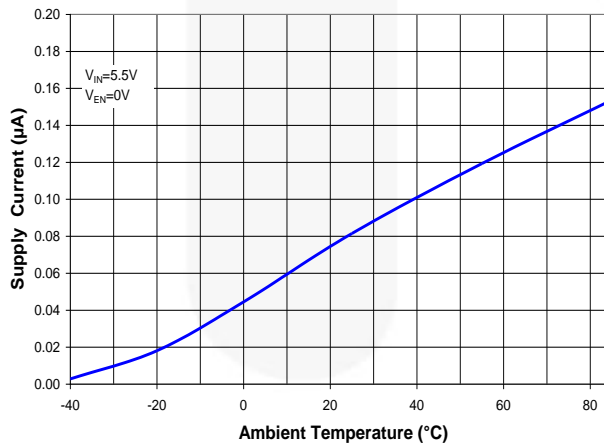

Figure 19. Shutdown Current vs. Temperature

Typical Performance Characteristics (Continued)

Unless otherwise noted, $V_{IN} = V_{EN} = 3.6\text{ V}$, $V_{MODE} = 0\text{ V}$ (AUTO Mode), $V_{OUT} = 1.82\text{ V}$, $T_A = 25^\circ\text{C}$, $5\mu\text{s}/\text{div}$. horizontal sweep.



Figure 20. Line Transient 3.3 V_{IN} to 3.9 V_{IN} , 50 mA Load, 10 $\mu\text{s}/\text{div}$.

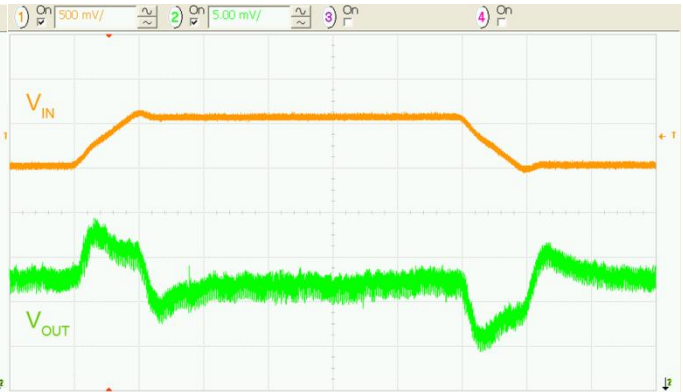

Figure 21. Line Transient 3.3 V_{IN} to 3.9 V_{IN} , 250 mA Load, 10 $\mu\text{s}/\text{div}$.



Figure 22. Combined Line/Load Transient 3.9 to 3.3 V_{IN} Combined with 40 mA to 400 mA Load Transient

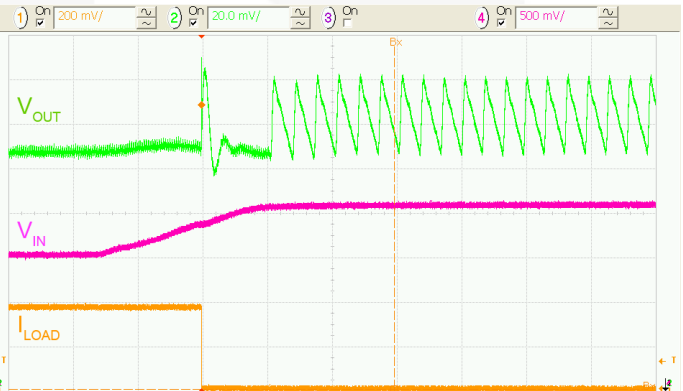

Figure 23. Combined Line/Load Transient 3.3 to 3.9 V_{IN} Combined with 400 mA to 40 mA Load Transient

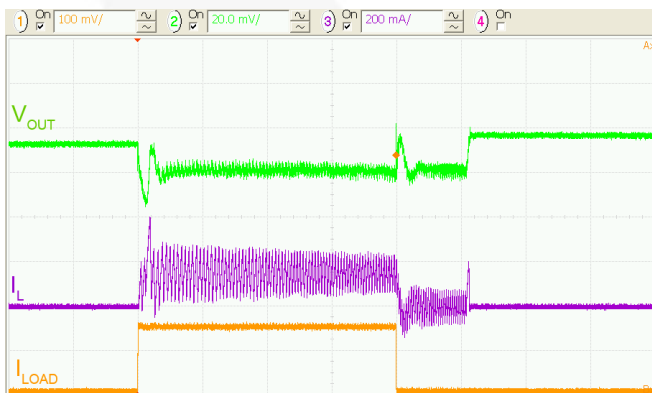

Figure 24. Load Transient 0 to 150 mA, 2.5 V_{IN}

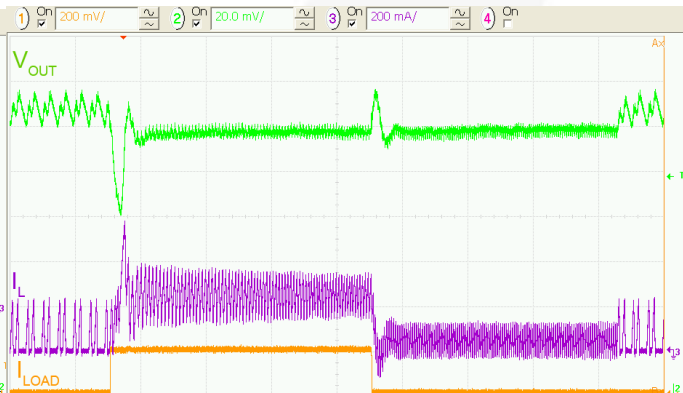

Figure 25. Load Transient 50 to 250 mA, 2.5 V_{IN}

Typical Performance Characteristics (Continued)

Unless otherwise noted, $V_{IN} = V_{EN} = 3.6\text{ V}$, $V_{MODE} = 0\text{ V}$ (AUTO Mode), $V_{OUT} = 1.82\text{ V}$, $T_A = 25^\circ\text{C}$, $5\text{ }\mu\text{s/div.}$ horizontal sweep.

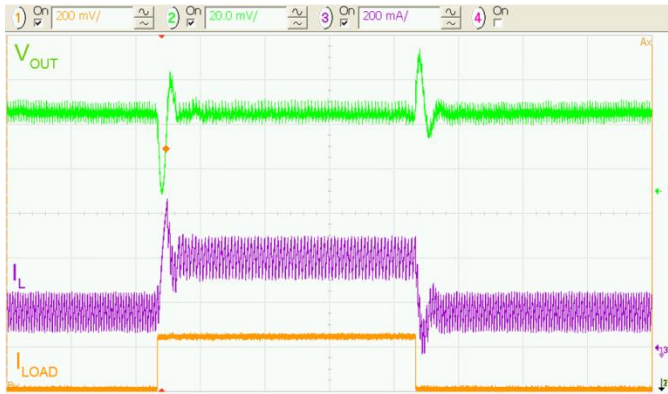

Figure 26. Load Transient 150 to 400 mA, 2.5 V_{IN}

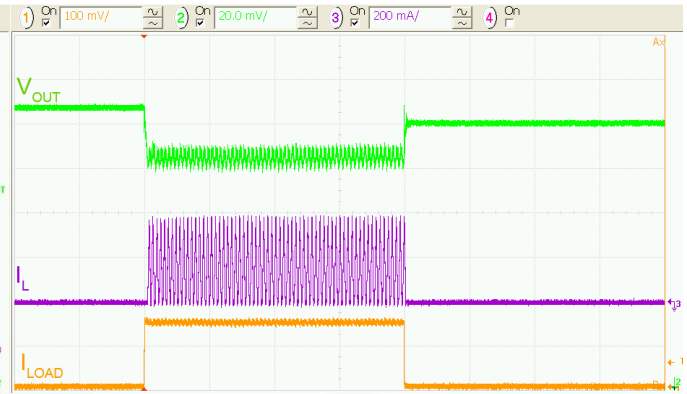

Figure 27. Load Transient 0 to 150 mA, 3.6 V_{IN}

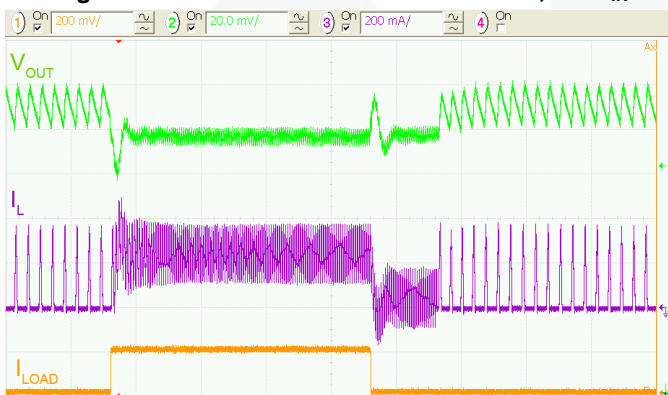

Figure 28. Load Transient 50 to 250 mA, 3.6 V_{IN}

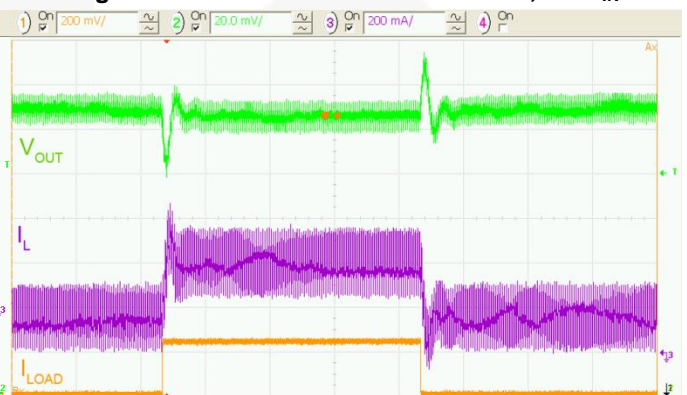

Figure 29. Load Transient 150 to 400 mA, 3.6 V_{IN}



Figure 30. Load Transient 0 to 150 mA, 4.5 V_{IN}

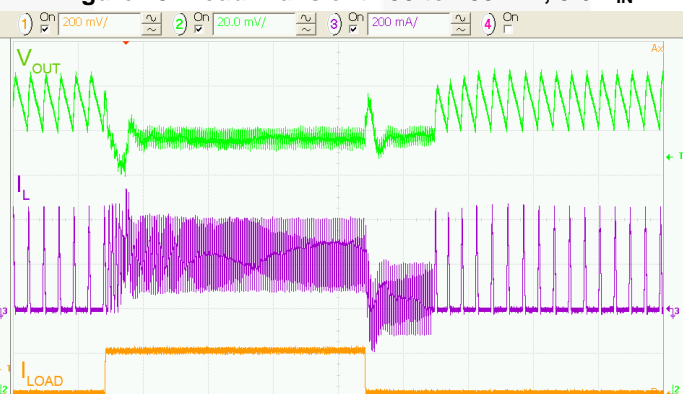

Figure 31. Load Transient 50 to 250 mA, 4.5 V_{IN}

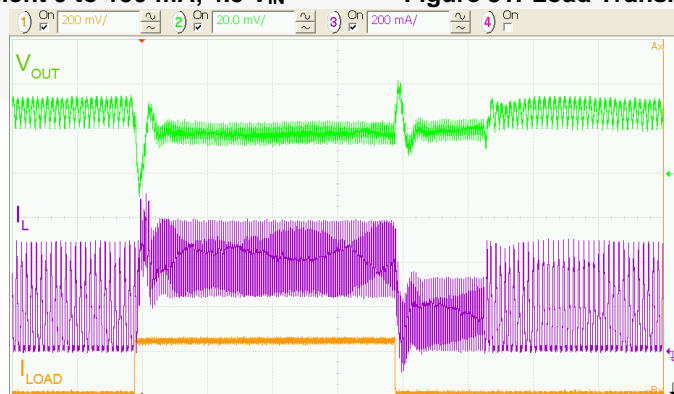

Figure 32. Load Transient 150 to 400 mA, 4.5 V_{IN}

Typical Performance Characteristics (Continued)

Unless otherwise noted, $V_{IN} = V_{EN} = 3.6\text{ V}$, $V_{MODE} = 0\text{ V}$ (AUTO Mode), $V_{OUT} = 1.82\text{ V}$, $T_A = 25^\circ\text{C}$, $5\ \mu\text{s}/\text{div}$. horizontal sweep.

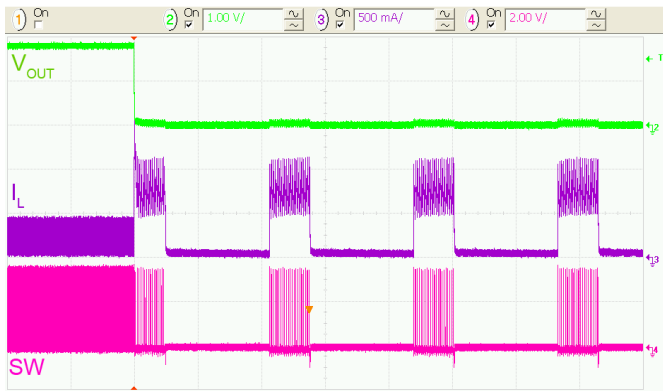

Figure 33. Metallic Short Applied at V_{OUT} , $50\ \mu\text{s}/\text{div}$.

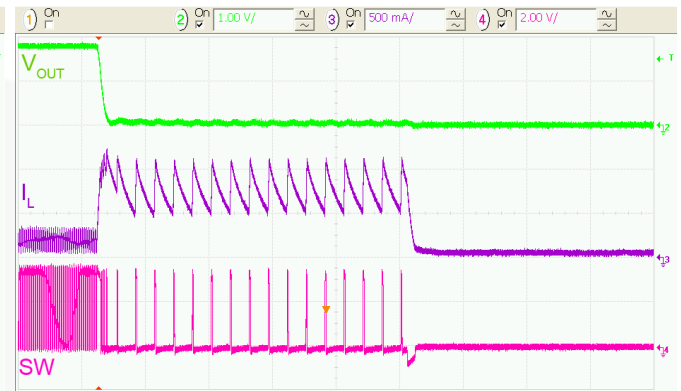

Figure 34. Metallic Short Applied at V_{OUT}



Figure 35. Over-Current Fault Response, $R_{LOAD} = 1\ \Omega$, $50\ \mu\text{s}/\text{div}$.

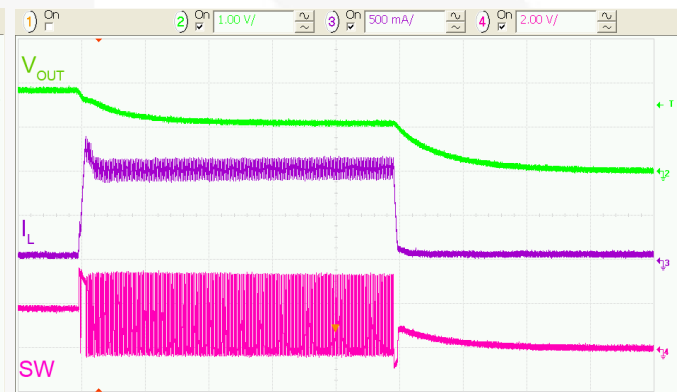

Figure 36. Over-Current Fault Response, $R_{LOAD} = 1\ \Omega$

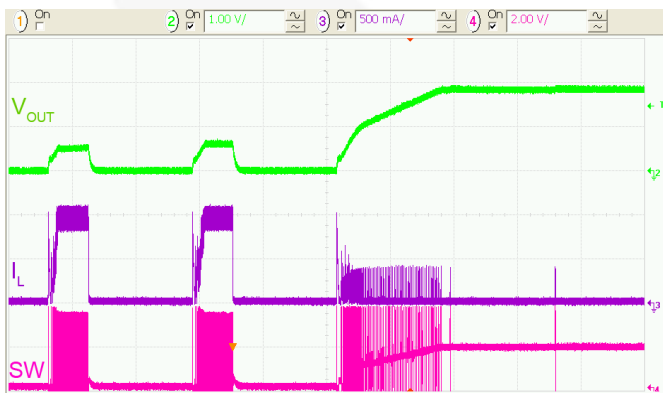

Figure 37. Overload Recovery to Light Load, $50\ \mu\text{s}/\text{div}$.

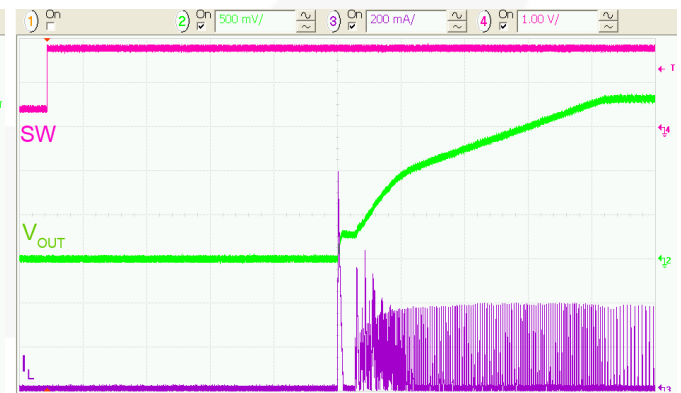

Figure 38. Soft-Start, $R_{LOAD} = 50\ \Omega$, $20\ \mu\text{s}/\text{div}$.

Typical Performance Characteristics (Continued)

Unless otherwise noted, $V_{IN} = V_{EN} = 3.6\text{ V}$, $V_{MODE} = 0\text{ V}$ (AUTO Mode), $V_{OUT} = 1.82\text{ V}$, $T_A = 25^\circ\text{C}$.



Figure 39. SW-Node Jitter (Infinite Persistence), $I_{LOAD} = 200\text{ mA}$, 50 ns/div.

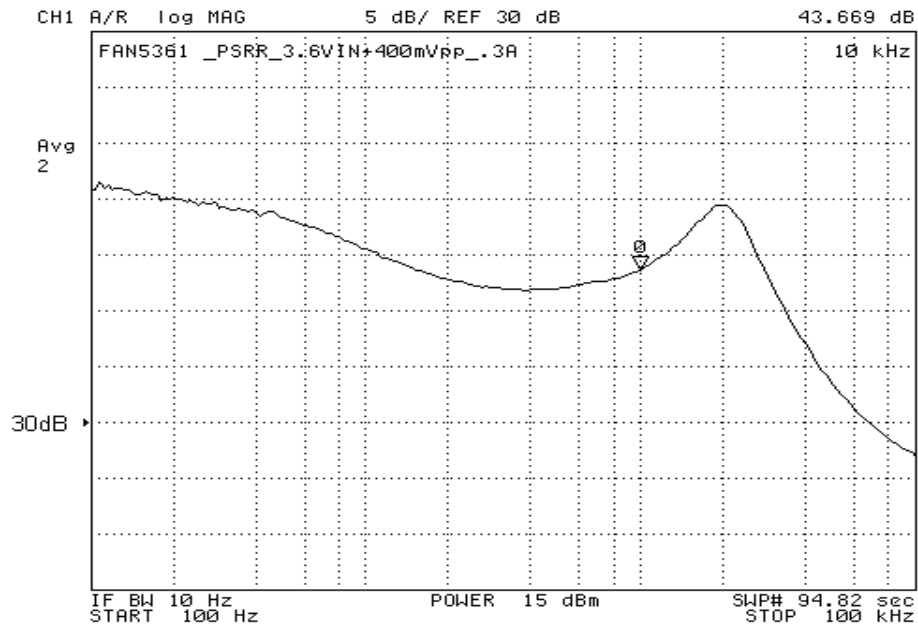

Figure 40. Power Supply Rejection Ratio at 300 mA Load

Operation Description

The FAN5361 is a 600 mA or 750 mA, step-down, switching voltage regulator that delivers a fixed output from an input voltage supply of 2.3 V to 5.5 V. Using a proprietary architecture with synchronous rectification, the FAN5361 is capable of delivering a peak efficiency of 92%, while maintaining efficiency over 80% at load currents as low as 1 mA. The regulator operates at a nominal frequency of 6 MHz at full load, which reduces the value of the external components to 470 nH for the inductor and 4.7 μ F for the output capacitor.

Control Scheme

The FAN5361 uses a proprietary, non-linear, fixed-frequency PWM modulator to deliver a fast load transient response, while maintaining a constant switching frequency over a wide range of operating conditions. The regulator performance is independent of the output capacitor ESR, allowing for the use of ceramic output capacitors. Although this type of operation normally results in a switching frequency that varies with input voltage and load current, an internal frequency loop holds the switching frequency constant over a large range of input voltages and load currents.

For very light loads, the FAN5361 operates in Discontinuous Current Mode (DCM) single-pulse PFM mode, which produces low output ripple compared with other PFM architectures. Transition between PWM and PFM is seamless, with a glitch of less than 18 mV at V_{OUT} during the transition between DCM and CCM modes.

Combined with exceptional transient response characteristics, the very low quiescent current of the controller (35 μ A) maintains high efficiency; even at very light loads, while preserving fast transient response for applications requiring tight output regulation.

Enable and Soft-Start

When EN is LOW, all circuits in FAN5361 are off and the IC draws ~50 nA of current. When EN is HIGH and V_{IN} is above its UVLO threshold, the regulator begins a soft-start cycle. The output ramp during soft-start is a fixed slew rate of 50 mV/ μ s from 0 to 1 V_{OUT} , then 12.5 mV/ μ s until the output reaches its setpoint. Regardless of the state of the MODE pin, PFM mode is enabled to prevent current from being discharged from C_{OUT} if soft-start begins when C_{OUT} is charged.

The IC may fail to start if heavy load is applied during startup and/or if excessive C_{OUT} is used. This is due to the current-limit fault response, which protects the IC in the event of an over-current condition present during soft-start.

The current required to charge C_{OUT} during soft-start is commonly referred to as “displacement current” is given as:

$$I_{DISP} = C_{OUT} \cdot \frac{dV}{dt} \quad (1)$$

where the $\frac{dV}{dt}$ term refers to the soft-start slew rate above.

To prevent shut-down during soft-start, the following condition must be met:

$$I_{DISP} + I_{LOAD} < I_{MAX(DC)} \quad (2)$$

where $I_{MAX(DC)}$ is the maximum load current the IC is guaranteed to support (600 mA or 750 mA).

Table 1 shows combinations of C_{OUT} that allow the IC to start successfully with the minimum R_{LOAD} that can be supported.

Table 1. Minimum R_{LOAD} Values for Soft-Start with Various C_{OUT} Values

C_{OUT}	Minimum R_{LOAD}
4.7 μ F, 0402	$V_{OUT} / 0.60$
2 X 4.7 μ F, 0402	$V_{OUT} / 0.60$
10 μ F, 0603	$V_{OUT} / 0.60$
10 μ F, 0805	$V_{OUT} / 0.50$

Startup into Large C_{OUT}

Multiple soft-start cycles are required for no-load startup if C_{OUT} is greater than 15 μ F. Large C_{OUT} requires light initial load to ensure the FAN5361 starts appropriately. The IC shuts down for 85 μ s when I_{DISP} exceeds I_{LIMIT} for more than 21 μ s of current limit. The IC then begins a new soft-start cycle. Since C_{OUT} retains its charge when the IC is off, the IC reaches regulation after multiple soft-start attempts.

MODE Pin

Logic 1 on this pin forces the IC to stay in PWM mode. A logic 0 allows the IC to automatically switch to PFM during light loads. If the MODE pin is toggled, the converter synchronizes its switching frequency to four times the frequency on the mode pin (f_{MODE}).

The MODE pin is internally buffered with a Schmitt trigger, which allows the MODE pin to be driven with slow rise and fall times. An asymmetric duty cycle for frequency synchronization is also permitted as long as the minimum time below $V_{IL(MAX)}$ or above $V_{IH(MAX)}$ is 100 ns.

Current Limit, Fault Shutdown, and Restart

A heavy load or short circuit on the output causes the current in the inductor to increase until a maximum current threshold is reached in the high-side switch. Upon reaching this point, the high-side switch turns off, preventing high currents from causing damage. The regulator continues to limit the current cycle-by-cycle. After 21 μ s of current limit, the regulator triggers an over-current fault, causing the regulator to shut down for about 85 μ s before attempting a restart.

If the fault was caused by short circuit, the soft-start circuit attempts to restart and produces an over-current fault after about 32 μ s, which results in a duty cycle of less than 30%, limiting power dissipation.

The closed-loop peak-current limit, $I_{LIM(PK)}$, is not the same as the open-loop tested current limit, $I_{LIM(OL)}$, in the Electrical Characteristics table. This is primarily due to the effect of propagation delays of the IC current limit comparator.

Under-Voltage Lockout (UVLO)

When EN is HIGH, the under-voltage lockout keeps the part from operating until the input supply voltage rises high enough to properly operate. This ensures no misbehavior of the regulator during startup or shutdown.

Thermal Shutdown (TSD)

When the die temperature increases, due to a high load condition and/or a high ambient temperature, the output switching is disabled until the temperature on the die has fallen sufficiently. The junction temperature at which the thermal shutdown activates is nominally 150°C with a 15°C hysteresis.

Minimum Off-Time Effect on Switching Frequency

$t_{OFF(MIN)}$ is 50 ns. This imposes constraints on the maximum $\frac{V_{OUT}}{V_{IN}}$ that the FAN5361 can provide, or the maximum output voltage it can provide at low V_{IN} while maintaining a fixed switching frequency in PWM mode.

When V_{IN} is LOW, fixed switching is maintained as long as

$$\frac{V_{OUT}}{V_{IN}} \leq 1 - t_{OFF(MIN)} \cdot f_{SW} \approx 0.7 .$$

The switching frequency drops when the regulator cannot provide sufficient duty cycle at 6MHz to maintain regulation. This occurs when V_{OUT} is greater than or equal to 1.82 V and V_{IN} is below 2.9 V at high load currents (see Figure 15).

The calculation for switching frequency is given by:

$$f_{SW} = \min \left(\frac{1}{t_{SW(MAX)}}, 6MHz \right) \quad (3)$$

where:

$$t_{SW(MAX)} = 50ns \cdot \left(1 + \frac{V_{OUT} + I_{OUT} \cdot R_{OFF}}{V_{IN} - I_{OUT} \cdot R_{ON} - V_{OUT}} \right) \quad (4)$$

where:

$$R_{OFF} = R_{DSON_N} + DCR_L$$

$$R_{ON} = R_{DSON_P} + DCR_L$$

Applications Information

Selecting the Inductor

The output inductor must meet both the required inductance and the energy handling capability of the application. The inductor value affects average current limit, the PWM-to-PFM transition point, output voltage ripple, and efficiency.

The ripple current (ΔI) of the regulator is:

$$\Delta I \approx \frac{V_{OUT}}{V_{IN}} \cdot \left(\frac{V_{IN} - V_{OUT}}{L \cdot f_{SW}} \right) \quad (5)$$

The maximum average load current, $I_{MAX(Load)}$, is related to the peak current limit, $I_{LIM(PK)}$ by the ripple current, given by:

$$I_{MAX(Load)} = I_{LIM(PK)} - \frac{\Delta I}{2} \quad (6)$$

The transition between PFM and PWM operation is determined by the point at which the inductor valley current crosses zero. The regulator DC current when the inductor current crosses zero, I_{DCM} , is:

$$I_{DCM} = \frac{\Delta I}{2} \quad (7)$$

The FAN5361 is optimized for operation with $L = 470$ nH, but is stable with inductances up to $1.2 \mu\text{H}$ (nominal). Up to $2.2 \mu\text{H}$ (nominal) may be used; however, in that case, V_{IN} must be greater than or equal to 2.7 V. The inductor should be rated to maintain at least 80% of its value at $I_{LIM(PK)}$.

Efficiency is affected by the inductor DCR and inductance value. Decreasing the inductor value for a given physical size typically decreases the DCR; but since ΔI increases, the RMS current increases, as do the core and skin effect losses.

$$I_{RMS} = \sqrt{I_{OUT(DC)}^2 + \frac{\Delta I^2}{12}} \quad (8)$$

The increased RMS current produces higher losses through the $R_{DS(ON)}$ of the IC MOSFETs, as well as the inductor DCR.

Increasing the inductor value produces lower RMS currents, but degrades transient response. For a given physical inductor size, increased inductance usually results in an inductor with lower saturation current and higher DCR.

Table 2 shows the effects of inductance higher or lower than the recommended 470 nH on regulator performance.

Output Capacitor

Table 3 suggests 0402 capacitors. 0603 capacitors may further improve performance in that the effective capacitance is higher. This improves transient response and output ripple.

Increasing C_{OUT} has no effect on loop stability and can therefore be increased to reduce output voltage ripple or to improve transient response. Output voltage ripple, ΔV_{OUT} , is:

$$\Delta V_{OUT} = \Delta I \cdot \left(\frac{1}{8 \cdot C_{OUT} \cdot f_{SW}} + ESR \right) \quad (9)$$

Input Capacitor

The $2.2 \mu\text{F}$ ceramic input capacitor should be placed as close as possible between the V_{IN} pin and GND to minimize the parasitic inductance. If a long wire is used to bring power to the IC, additional "bulk" capacitance (electrolytic or tantalum) should be placed between C_{IN} and the power source lead to reduce ringing that can occur between the inductance of the power source leads and C_{IN} .

The effective capacitance value decreases as V_{IN} increases due to DC bias effects.

Table 2. Effects of Changes in Inductor Value (from 470 nH Recommended Value) on Regulator Performance

Inductor Value	$I_{MAX(Load)}$	ΔV_{OUT}	Transient Response
Increase	Increase	Decrease	Degraded
Decrease	Decrease	Increase	Improved

Table 3. Recommended Passive Components and their Variation Due to DC Bias

Component	Description	Vendor	Min.	Typ.	Max. ⁽⁶⁾	Comment
L1	470 nH, 2012, 90 mΩ, 1.1 A	Murata LQM21PNR47MC0 Murata LQM21PNR54MG0 Hitachi Metals HSLI-201210AG-R47	300 nH	470 nH	520 nH	Minimum value occurs at maximum current
C_{IN}	2.2 μF , 6.3 V, X5R, 0402	Murata or Equivalent GRM155R60J225ME15 GRM188R60J225KE19D	1.0 μF	2.2 μF	2.4 μF	Decrease primarily due to DC bias (V_{IN}) and elevated temperature
C_{OUT}	4.7 μF , X5R, 0402	Murata or Equivalent GRM155R60G475M GRM155R60E475ME760	1.6 μF	4.7 μF	5.2 μF	Decrease primarily due to DC bias (V_{OUT})

Note:

6. Higher inductance values are also acceptable. See "Selecting the Inductor" instructions in Applications Information.

PCB Layout Guidelines

There are only three external components: the inductor and the input and output capacitors. For any buck switcher IC, including the FAN5361, it is important to place a low-ESR input capacitor very close to the IC, as shown in Figure 41. The input capacitor ensures good input decoupling, which helps reduce noise appearing at the output terminals and ensures that the control sections of the IC do not behave

erratically due to excessive noise. This reduces switching cycle jitter and ensures good overall performance. It is important to place the common GND of C_{IN} and C_{OUT} as close as possible to the FAN5361 C2 terminal. There is some flexibility in moving the inductor further away from the IC; in that case, V_{OUT} should be considered at the C_{OUT} terminal.

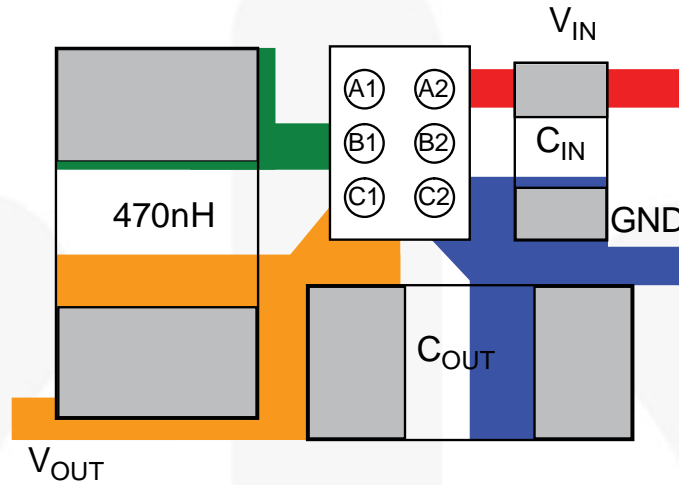
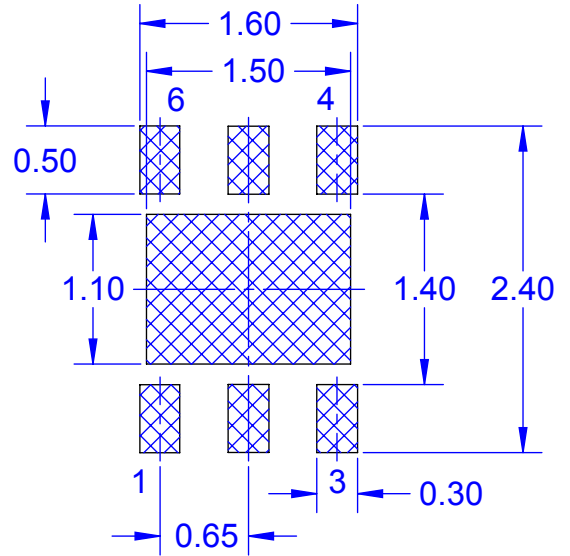
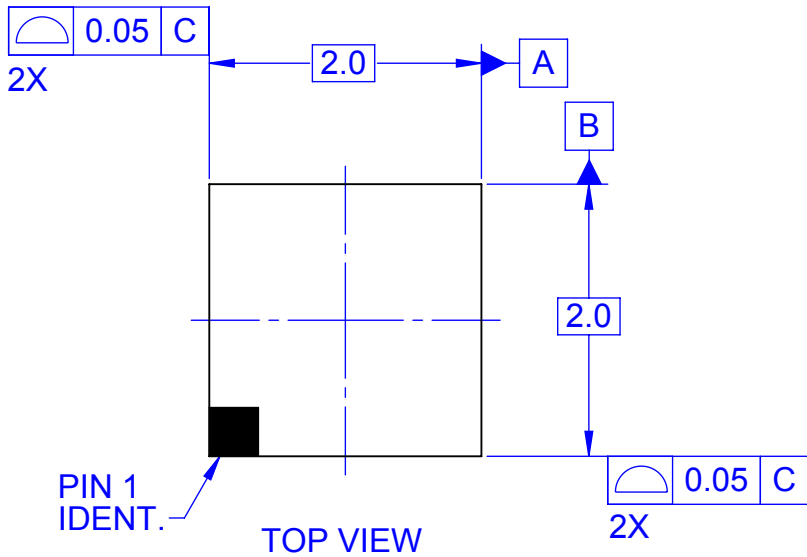

Figure 41. PCB Layout Guidance

The table below pertains to the Marketing Outline Drawing on the following page.

Product-Specific Dimensions

Product	D	E	X	Y
FAN5361UCX	1.370 ±0.040	0.970 ±0.040	0.285	0.285



LAND PATTERN RECOMMENDATION

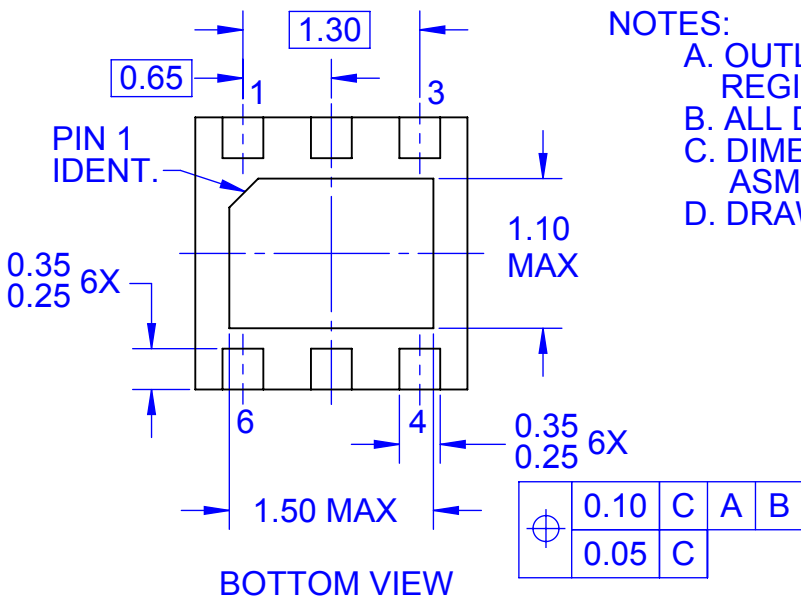
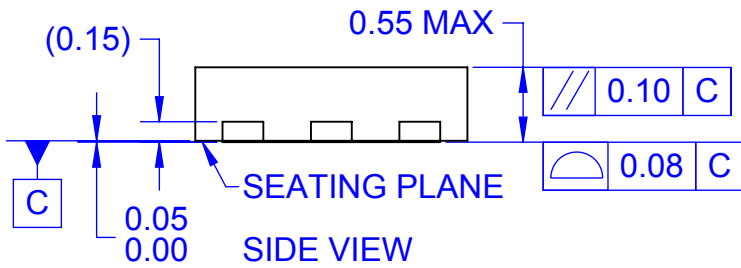

NOTES:

- A. OUTLINE BASED ON JEDEC REGISTRATION MO-229, VARIATION VCCC
- B. ALL DIMENSIONS ARE IN MILLIMETERS
- C. DIMENSIONS AND TOLERANCES PER ASME Y14.5, 2009
- D. DRAWING FILENAME: MKT-UMLP06Crev2



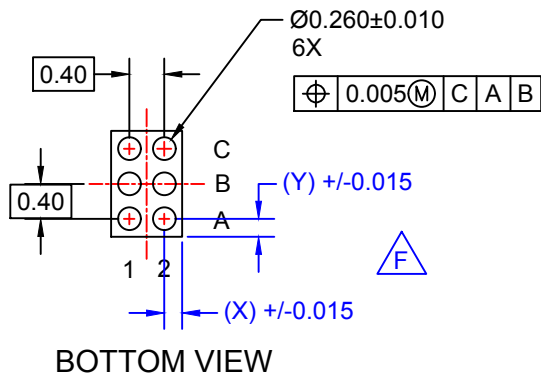
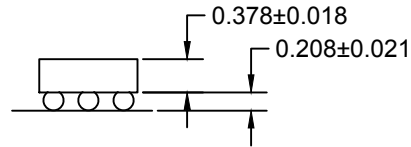
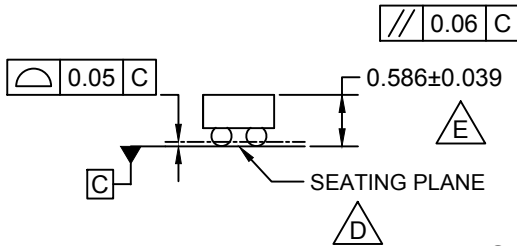
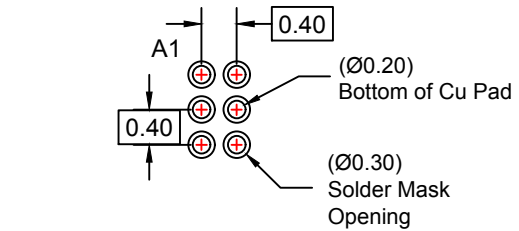
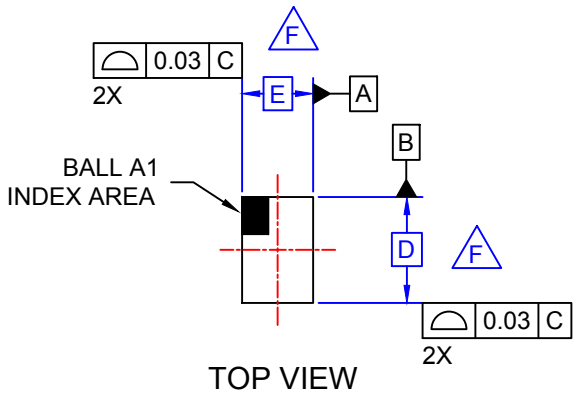

NOTES:

- A. NO JEDEC REGISTRATION APPLIES.
- B. DIMENSIONS ARE IN MILLIMETERS.
- C. DIMENSIONS AND TOLERANCES PER ASMEY14.5M, 2009.
- D.** DATUM C, THE SEATING PLANE IS DEFINED BY THE SPHERICAL CROWNS OF THE BALLS.
- E.** PACKAGE TYPICAL HEIGHT IS 586 MICRONS ±39 MICRONS (547-625 MICRONS).
- F.** FOR DIMENSIONS D, E, X, AND Y, SEE PRODUCT DATASHEET.
- G. DRAWING FILENAME: MKT-UC006ACrev6.





TRADEMARKS

The following includes registered and unregistered trademarks and service marks, owned by Fairchild Semiconductor and/or its global subsidiaries, and is not intended to be an exhaustive list of all such trademarks.

- AccuPower™
- AttitudeEngine™
- Awinda®
- AX-CAP®*
- BitSiC™
- Build it Now™
- CorePLUS™
- CorePOWER™
- CROSSVOL™
- CTL™
- Current Transfer Logic™
- DEUXPEED®
- Dual Cool™
- EcoSPARK®
- EfficientMax™
- ESBC™
- F**™
- Fairchild®
- Fairchild Semiconductor®
- FACT Quiet Series™
- FACT®
- FastvCore™
- FETBench™
- FPS™
- F-PFS™
- FRFET®
- Global Power ResourceSM
- GreenBridge™
- Green FPS™
- Green FPS™ e-Series™
- Gmax™
- GTO™
- IntelliMAX™
- ISOPLANAR™
- Making Small Speakers Sound Louder and Better™
- MegaBuck™
- MICROCOUPLER™
- MicroFET™
- MicroPak™
- MicroPak2™
- MillerDrive™
- MotionMax™
- MotionGrid®
- MTi®
- MTx®
- MVN®
- mWSaver®
- OptoHiT™
- OPTOLOGIC®
- OPTOPLANAR®
- ®
- Power Supply WebDesigner™
- PowerTrench®
- PowerXS™
- Programmable Active Droop™
- QFET®
- QS™
- Quiet Series™
- RapidConfigure™
- ™
- Saving our world, 1mW/W/kW at a time™
- SignalWise™
- SmartMax™
- SMART START™
- Solutions for Your Success™
- SPM®
- STEALTH™
- SuperFET®
- SuperSOT™-3
- SuperSOT™-6
- SuperSOT™-8
- SupreMOS®
- SyncFET™
- Sync-Lock™
- ®
- TinyBoost®
- TinyBuck®
- TinyCalc™
- TinyLogic®
- TINYOPTO™
- TinyPower™
- TinyPWM™
- TinyWire™
- TranSiC™
- TriFault Detect™
- TRUECURRENT®*
- μSerDes™
- ™
- UHC®
- Ultra FRFET™
- UniFET™
- VCX™
- VisualMax™
- VoltagePlus™
- XS™
- Xsens™
- 仙童®

* Trademarks of System General Corporation, used under license by Fairchild Semiconductor.

DISCLAIMER

FAIRCHILD SEMICONDUCTOR RESERVES THE RIGHT TO MAKE CHANGES WITHOUT FURTHER NOTICE TO ANY PRODUCTS HEREIN TO IMPROVE RELIABILITY, FUNCTION, OR DESIGN. TO OBTAIN THE LATEST, MOST UP-TO-DATE DATASHEET AND PRODUCT INFORMATION, VISIT OUR WEBSITE AT [HTTP://WWW.FAIRCHILDSEMI.COM](http://www.fairchildsemi.com). FAIRCHILD DOES NOT ASSUME ANY LIABILITY ARISING OUT OF THE APPLICATION OR USE OF ANY PRODUCT OR CIRCUIT DESCRIBED HEREIN; NEITHER DOES IT CONVEY ANY LICENSE UNDER ITS PATENT RIGHTS, NOR THE RIGHTS OF OTHERS. THESE SPECIFICATIONS DO NOT EXPAND THE TERMS OF FAIRCHILD'S WORLDWIDE TERMS AND CONDITIONS, SPECIFICALLY THE WARRANTY THEREIN, WHICH COVERS THESE PRODUCTS.

AUTHORIZED USE

Unless otherwise specified in this data sheet, this product is a standard commercial product and is not intended for use in applications that require extraordinary levels of quality and reliability. This product may not be used in the following applications, unless specifically approved in writing by a Fairchild officer: (1) automotive or other transportation, (2) military/aerospace, (3) any safety critical application – including life critical medical equipment – where the failure of the Fairchild product reasonably would be expected to result in personal injury, death or property damage. Customer's use of this product is subject to agreement of this Authorized Use policy. In the event of an unauthorized use of Fairchild's product, Fairchild accepts no liability in the event of product failure. In other respects, this product shall be subject to Fairchild's Worldwide Terms and Conditions of Sale, unless a separate agreement has been signed by both Parties.

ANTI-COUNTERFEITING POLICY

Fairchild Semiconductor Corporation's Anti-Counterfeiting Policy. Fairchild's Anti-Counterfeiting Policy is also stated on our external website, www.fairchildsemi.com, under Terms of Use

Counterfeiting of semiconductor parts is a growing problem in the industry. All manufacturers of semiconductor products are experiencing counterfeiting of their parts. Customers who inadvertently purchase counterfeit parts experience many problems such as loss of brand reputation, substandard performance, failed applications, and increased cost of production and manufacturing delays. Fairchild is taking strong measures to protect ourselves and our customers from the proliferation of counterfeit parts. Fairchild strongly encourages customers to purchase Fairchild parts either directly from Fairchild or from Authorized Fairchild Distributors who are listed by country on our web page cited above. Products customers buy either from Fairchild directly or from Authorized Fairchild Distributors are genuine parts, have full traceability, meet Fairchild's quality standards for handling and storage and provide access to Fairchild's full range of up-to-date technical and product information. Fairchild and our Authorized Distributors will stand behind all warranties and will appropriately address any warranty issues that may arise. Fairchild will not provide any warranty coverage or other assistance for parts bought from Unauthorized Sources. Fairchild is committed to combat this global problem and encourage our customers to do their part in stopping this practice by buying direct or from authorized distributors.

PRODUCT STATUS DEFINITIONS

Definition of Terms

Datasheet Identification	Product Status	Definition
Advance Information	Formative / In Design	Datasheet contains the design specifications for product development. Specifications may change in any manner without notice.
Preliminary	First Production	Datasheet contains preliminary data; supplementary data will be published at a later date. Fairchild Semiconductor reserves the right to make changes at any time without notice to improve design.
No Identification Needed	Full Production	Datasheet contains final specifications. Fairchild Semiconductor reserves the right to make changes at any time without notice to improve the design.
Obsolete	Not In Production	Datasheet contains specifications on a product that is discontinued by Fairchild Semiconductor. The datasheet is for reference information only.

Rev. I77