

# NGTB40N65IHRTG

## IGBT with Monolithic Reverse Conducting Diode

This Insulated Gate Bipolar Transistor (IGBT) features robust and cost effective Field Stop (FS2) trench construction with a monolithic RC Diode. It provides a cost effective Solution for applications where diode losses are minimal. The IGBT is optimized for low conduction losses (low  $V_{CEsat}$ ) and is well suited for resonant or soft switching applications.

### Features

- Extremely Efficient Trench with Fieldstop Technology
- Low Conduction Design for Soft Switching Application
- Reduced Power Dissipation in Inducting Heating Application
- Reliable and Cost Effective Single Die Solution
- This is a Pb-Free Device

### Typical Applications

- Inductive Heating
- Air Conditioning PFC
- Welding

### ABSOLUTE MAXIMUM RATINGS

Rating	Symbol	Value	Unit
Collector-emitter voltage	$V_{CES}$	650	V
Collector current @ $T_C = 25^\circ\text{C}$ @ $T_C = 100^\circ\text{C}$	$I_C$	80 40	A
Pulsed collector current, $T_{pulse}$ limited by $T_{Jmax}$ , 10 $\mu\text{s}$ pulse, $V_{GE} = 15\text{ V}$	$I_{CM}$	160	A
Diode forward current @ $T_C = 25^\circ\text{C}$ @ $T_C = 100^\circ\text{C}$	$I_F$	80 40	A
Diode pulsed current, $T_{pulse}$ limited by $T_{Jmax}$ , 10 $\mu\text{s}$ pulse, $V_{GE} = 0\text{ V}$	$I_{FM}$	160	A
Power Dissipation @ $T_C = 25^\circ\text{C}$ @ $T_C = 100^\circ\text{C}$	$P_D$	405 202	W
Operating junction temperature range	$T_J$	-40 to +175	$^\circ\text{C}$
Storage temperature range	$T_{stg}$	-55 to +175	$^\circ\text{C}$
Lead temperature for soldering, 1/8" from case for 5 seconds	$T_{SLD}$	260	$^\circ\text{C}$

Stresses exceeding those listed in the Maximum Ratings table may damage the device. If any of these limits are exceeded, device functionality should not be assumed, damage may occur and reliability may be affected.



ON Semiconductor®

[www.onsemi.com](http://www.onsemi.com)

**40 A, 650 V**  
 **$V_{CEsat} = 1.55\text{ V}$**   
 **$E_{off} = 0.42\text{ mJ}$**

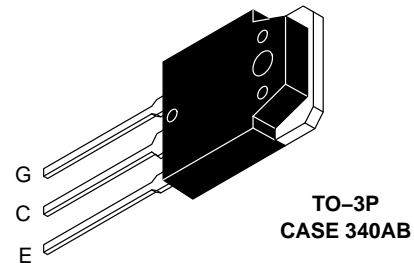
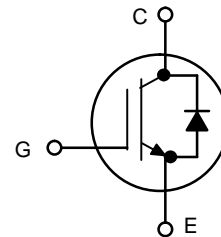

### MARKING DIAGRAM

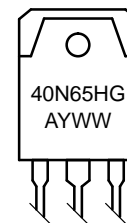

40N65H = Specific Device Code  
G = Pb-Free Package  
A = Assembly Location  
Y = Year  
WW = Work Week

### ORDERING INFORMATION

Device	Package	Shipping
NGTB40N65IHRTG	TO-3P (Pb-Free)	30 Units / Rail

# NGTB40N65IHRTG

## THERMAL CHARACTERISTICS

Rating	Symbol	Value	Unit
Thermal resistance junction-to-case	$R_{\theta JC}$	0.37	°C/W
Thermal resistance junction-to-ambient	$R_{\theta JA}$	40	°C/W

## ELECTRICAL CHARACTERISTICS ( $T_J = 25^\circ\text{C}$ unless otherwise specified)

Parameter	Test Conditions	Symbol	Min	Typ	Max	Unit
-----------	-----------------	--------	-----	-----	-----	------

### STATIC CHARACTERISTIC

Collector-emitter breakdown voltage, gate-emitter short-circuited	$V_{GE} = 0\text{ V}, I_C = 500\ \mu\text{A}$	$V_{(BR)CES}$	650	–	–	V
Collector-emitter saturation voltage	$V_{GE} = 15\text{ V}, I_C = 40\text{ A}$ $V_{GE} = 15\text{ V}, I_C = 40\text{ A}, T_J = 175^\circ\text{C}$	$V_{CEsat}$	–	1.55 1.95	1.7 –	V
Gate-emitter threshold voltage	$V_{GE} = V_{CE}, I_C = 350\ \mu\text{A}$	$V_{GE(th)}$	4.5	5.5	6.5	V
Collector-emitter cut-off current, gate-emitter short-circuited	$V_{GE} = 0\text{ V}, V_{CE} = 650\text{ V}$ $V_{GE} = 0\text{ V}, V_{CE} = 1200\text{ V}, T_J = 175^\circ\text{C}$	$I_{CES}$	–	– 1.0	0.3 –	mA
Gate leakage current, collector-emitter short-circuited	$V_{GE} = 20\text{ V}, V_{CE} = 0\text{ V}$	$I_{GES}$	–	–	100	nA

### DYNAMIC CHARACTERISTIC

Input capacitance	$V_{CE} = 20\text{ V}, V_{GE} = 0\text{ V}, f = 1\text{ MHz}$	$C_{ies}$	–	4628	–	pF
Output capacitance		$C_{oes}$	–	148	–	
Reverse transfer capacitance		$C_{res}$	–	126	–	
Gate charge total	$V_{CE} = 400\text{ V}, I_C = 40\text{ A}, V_{GE} = 15\text{ V}$	$Q_g$	–	190	–	nC
Gate to emitter charge		$Q_{ge}$	–	38	–	
Gate to collector charge		$Q_{gc}$	–	90	–	

### SWITCHING CHARACTERISTIC, INDUCTIVE LOAD

Turn-off delay time	$T_J = 25^\circ\text{C}$ $V_{CC} = 400\text{ V}, I_C = 40\text{ A}$ $R_g = 10\ \Omega$ $V_{GE} = 0\text{ V}/15\text{ V}$	$t_{d(off)}$	–	197	–	ns
Fall time		$t_f$	–	74	–	
Turn-off switching loss		$E_{off}$	–	0.42	–	
Turn-off delay time	$T_J = 175^\circ\text{C}$ $V_{CC} = 400\text{ V}, I_C = 40\text{ A}$ $R_g = 10\ \Omega$ $V_{GE} = 0\text{ V}/15\text{ V}$	$t_{d(off)}$	–	210	–	ns
Fall time		$t_f$	–	106	–	
Turn-off switching loss		$E_{off}$	–	0.7	–	

### DIODE CHARACTERISTIC

Forward voltage	$V_{GE} = 0\text{ V}, I_F = 40\text{ A}$ $V_{GE} = 0\text{ V}, I_F = 40\text{ A}, T_J = 175^\circ\text{C}$	$V_F$	–	1.50 1.70	1.80 –	V
-----------------	---	-------	---	--------------	-----------	---

Product parametric performance is indicated in the Electrical Characteristics for the listed test conditions, unless otherwise noted. Product performance may not be indicated by the Electrical Characteristics if operated under different conditions.

# NGTB40N65IHRTG

## TYPICAL CHARACTERISTICS

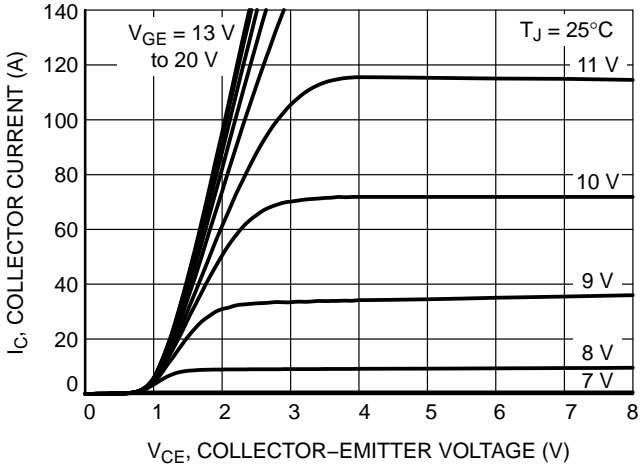

Figure 1. Output Characteristics

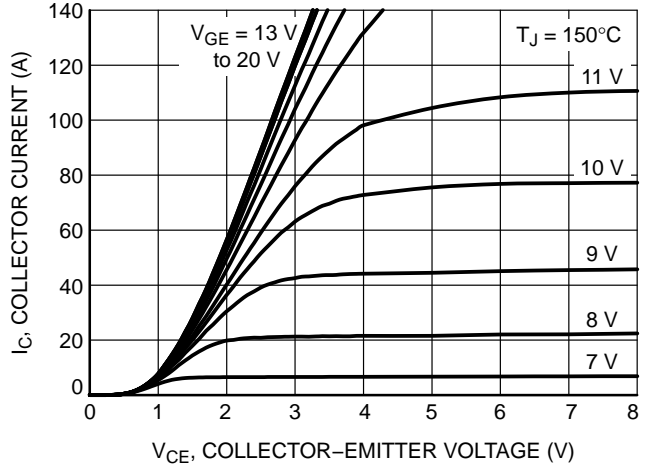

Figure 2. Output Characteristics

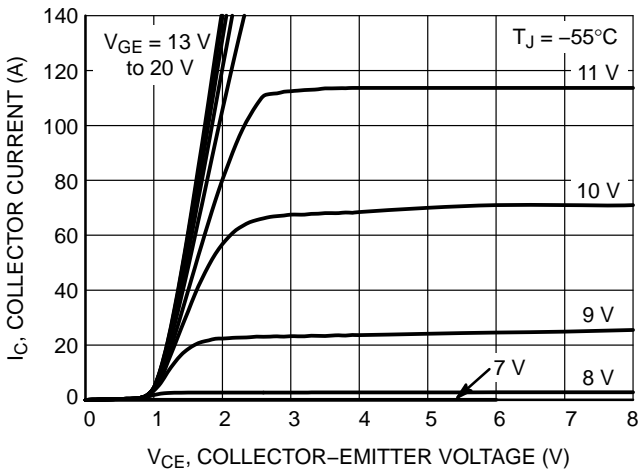

Figure 3. Output Characteristics

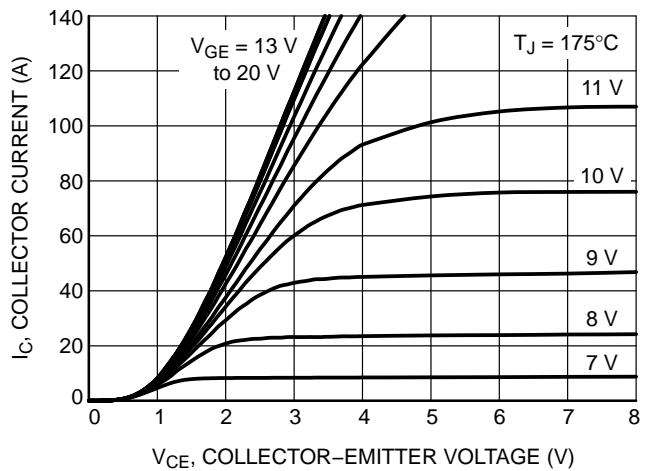

Figure 4. Output Characteristics

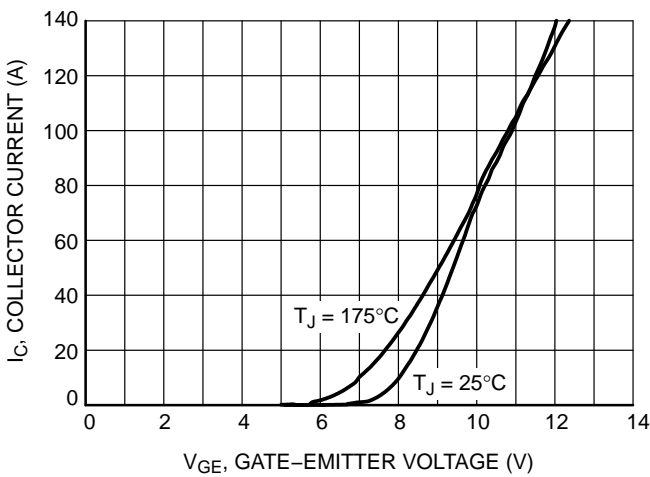

Figure 5. Typical Transfer Characteristics

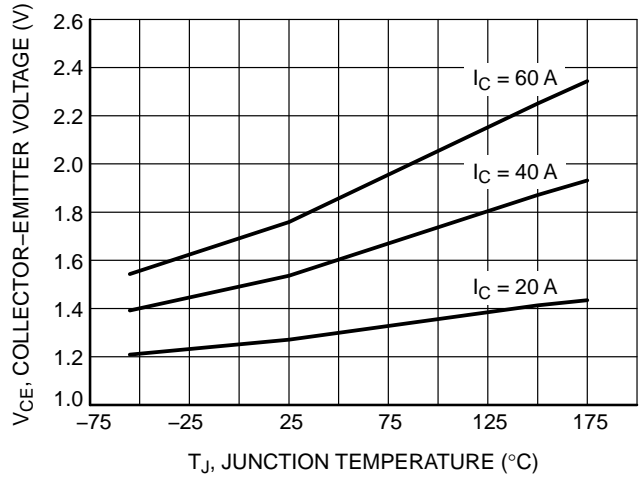

Figure 6.  $V_{CE(sat)}$  vs.  $T_J$

# NGTB40N65IHRTG

## TYPICAL CHARACTERISTICS

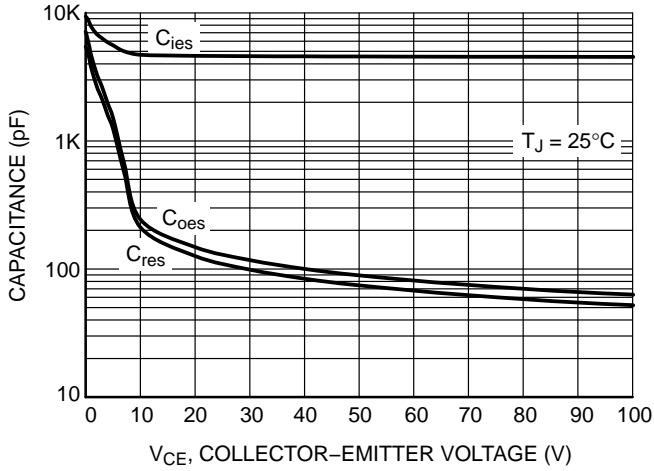

Figure 7. Typical Capacitance

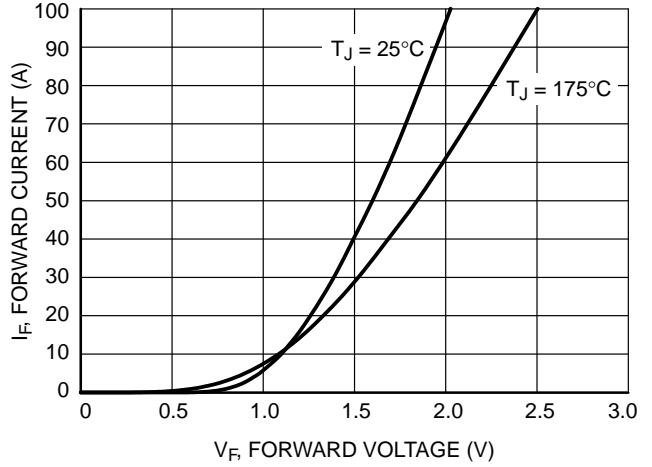

Figure 8. Diode Forward Characteristics

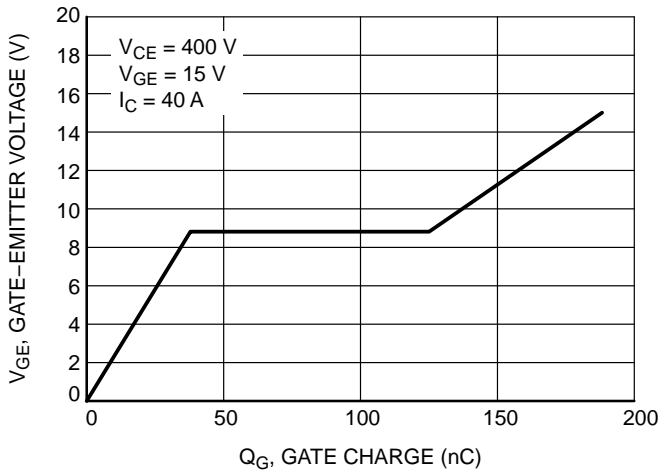

Figure 9. Typical Gate Charge

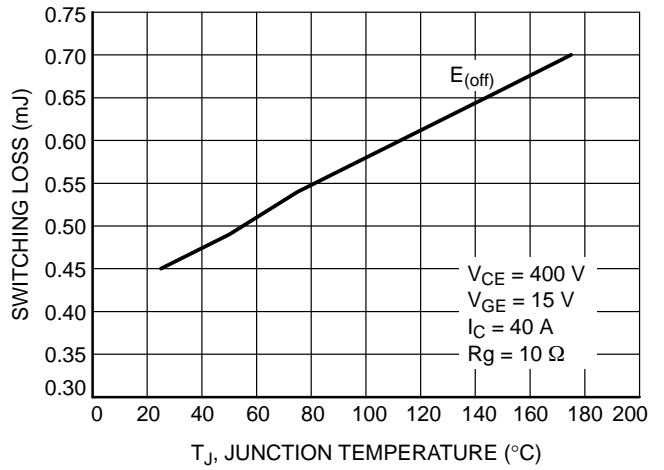

Figure 10. Switching Loss vs. Temperature

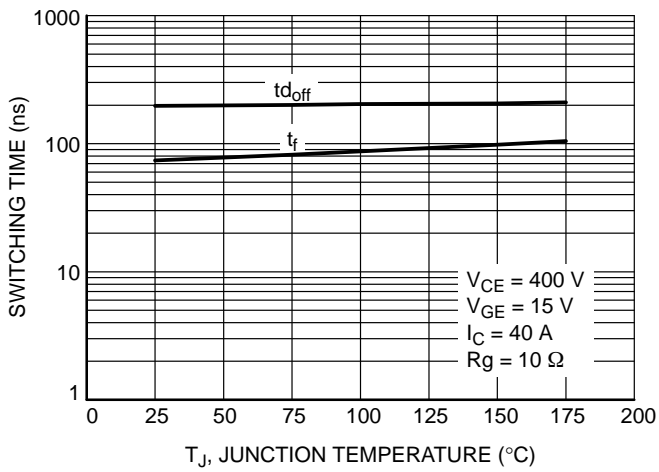

Figure 11. Switching Time vs. Temperature

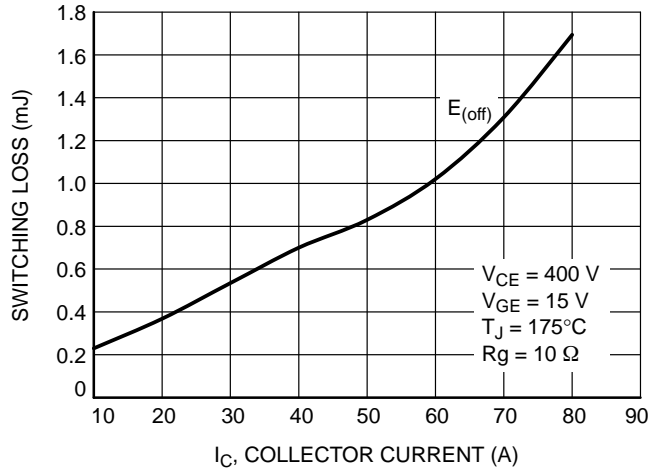

Figure 12. Switching Loss vs.  $I_C$

# NGTB40N65IHRTG

## TYPICAL CHARACTERISTICS

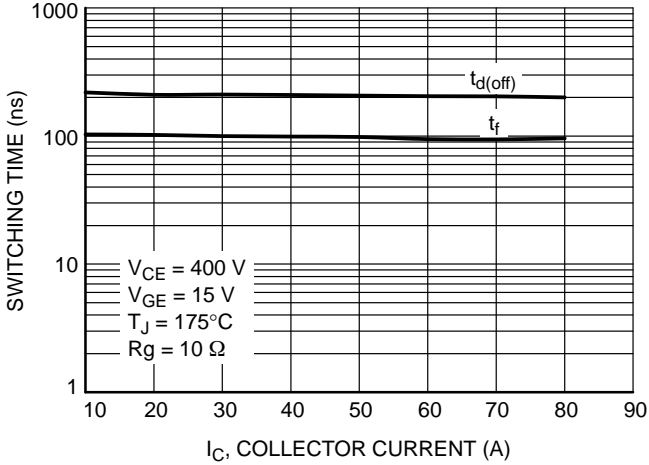

Figure 13. Switching Time vs.  $I_C$

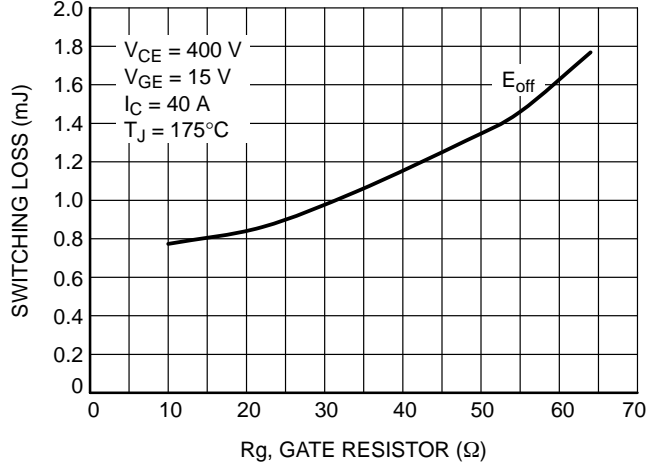

Figure 14. Switching Loss vs.  $R_g$

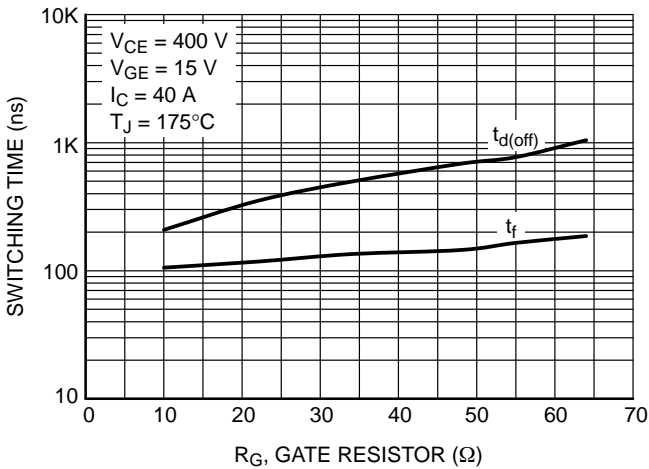

Figure 15. Switching Time vs.  $R_g$

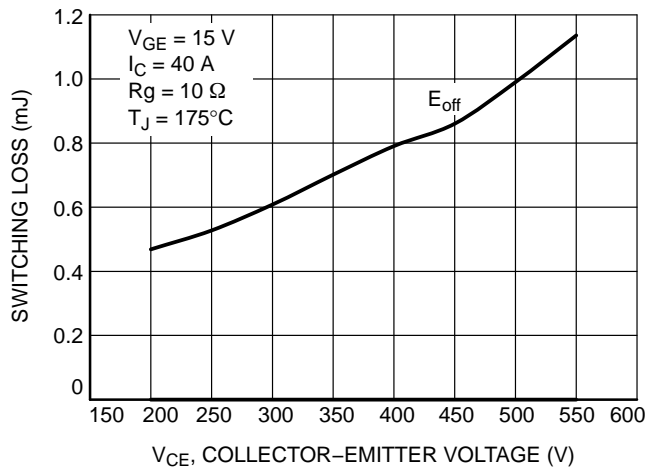

Figure 16. Switching Loss vs.  $V_{CE}$

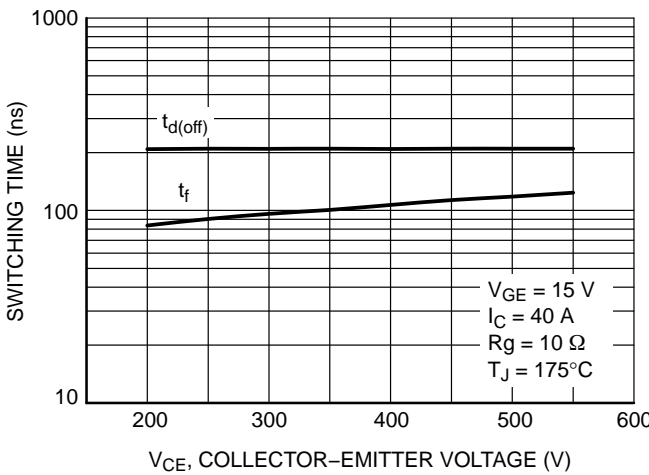

Figure 17. Switching Time vs.  $V_{CE}$

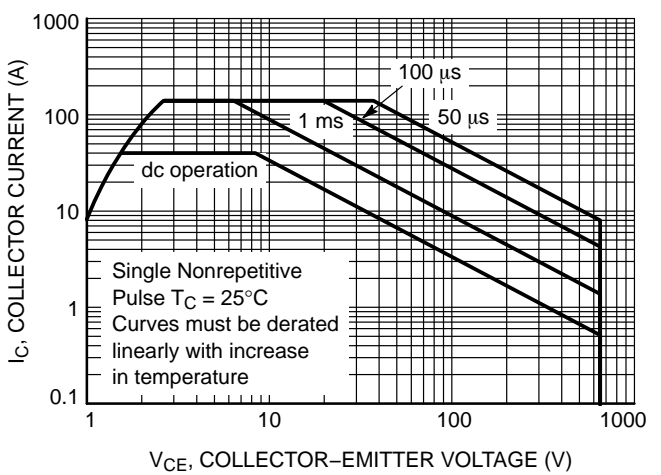

Figure 18. Safe Operating Area

# NGTB40N65IHRTG

## TYPICAL CHARACTERISTICS

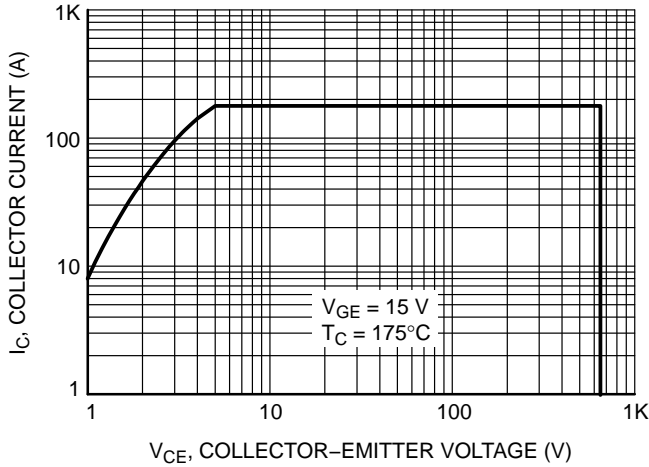

Figure 19. Reverse Bias Safe Operating Area

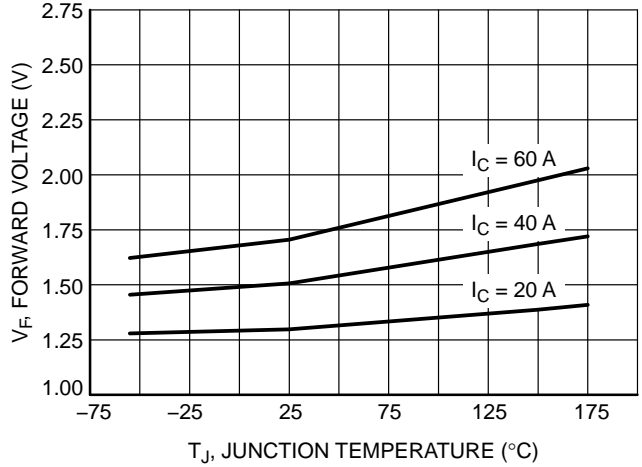

Figure 20. Forward Voltage vs. Junction Temperature

### NGTB40N65IHRTG IGBT die self-heating square-wave duty cycle transient thermal response

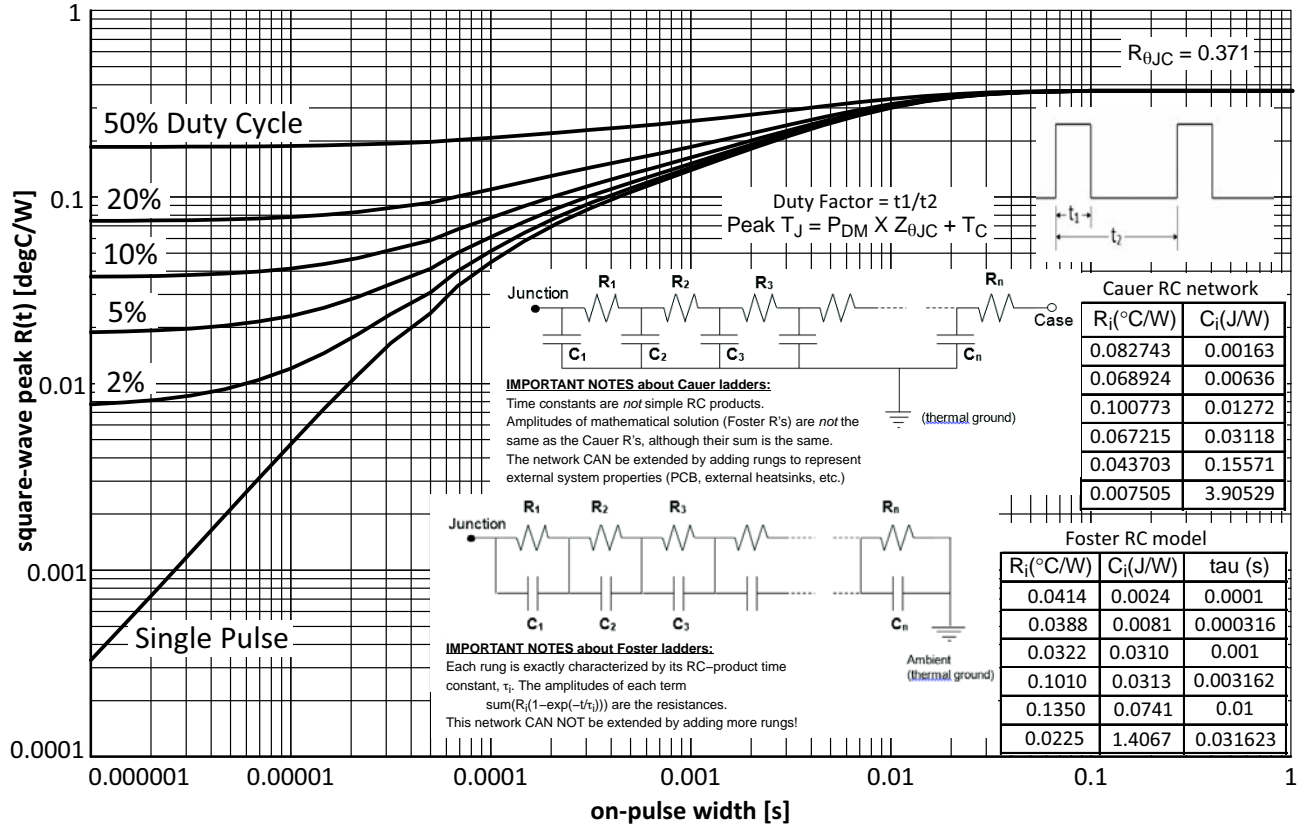

Figure 21. IGBT Transient Thermal Impedance

# NGTB40N65IHRTG

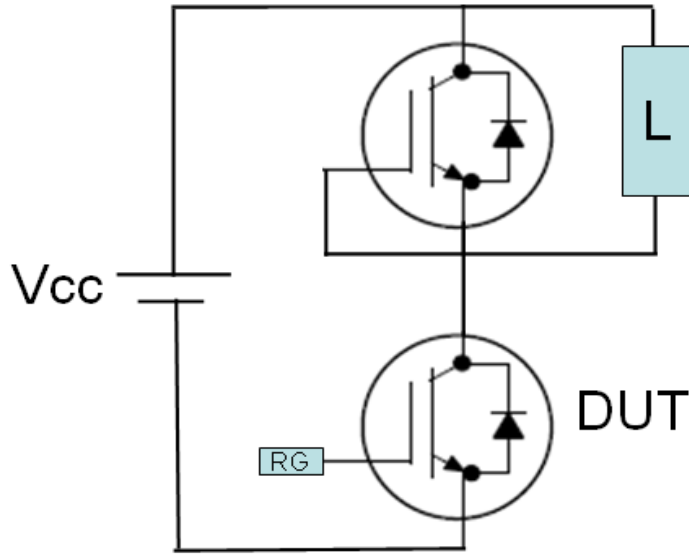

Figure 22. Test Circuit for Switching Characteristics

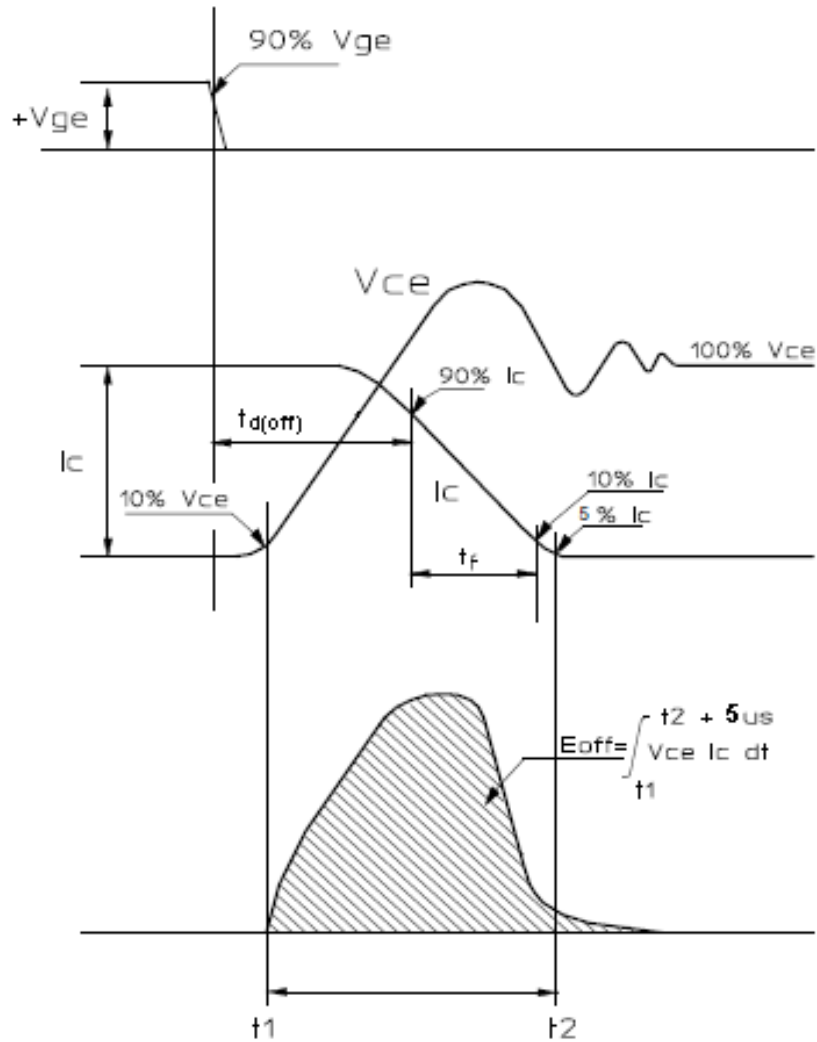

Figure 23. Definition of Turn Off Waveform

# MECHANICAL CASE OUTLINE PACKAGE DIMENSIONS

ON Semiconductor®



## TO-3P-3LD CASE 340AB-01 ISSUE A

DATE 30 OCT 2007

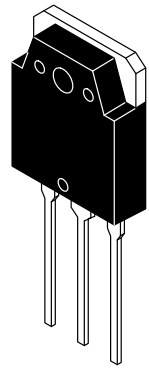

SCALE 1:1

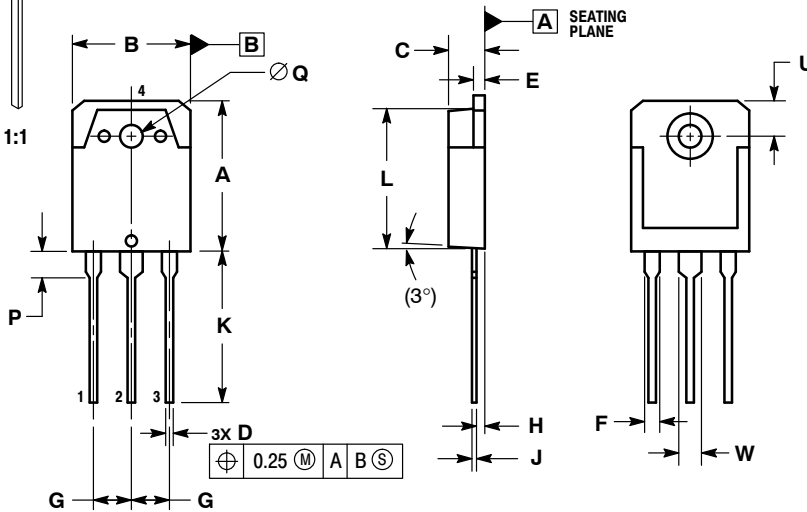

**NOTES:**

1. DIMENSIONING AND TOLERANCING PER ASME Y14.5M, 1994.
2. CONTROLLING DIMENSION: MILLIMETERS
3. DIMENSION b APPLIES TO PLATED TERMINAL AND IS MEASURED BETWEEN 0.15 AND 0.30mm FROM THE TERMINAL TIP.
4. DIMENSION A AND B DO NOT INCLUDE MOLD FLASH, PROTRUSIONS, OR GATE BURRS.

DIM	MILLIMETERS		
	MIN	NOM	MAX
A	19.70	19.90	20.10
B	15.40	15.60	15.80
C	4.60	4.80	5.00
D	0.80	1.00	1.20
E	1.45	1.50	1.65
F	1.80	2.00	2.20
G	5.45 BSC		
H	1.20	1.40	1.60
J	0.55	0.60	0.75
K	19.80	20.00	20.20
L	18.50	18.70	18.90
P	3.30	3.50	3.70
Q	3.10	3.20	3.50
U	5.00 REF		
W	2.80	3.00	3.20

**STYLE 1:**

- PIN 1. BASE
- 2. COLLECTOR
- 3. EMITTER
- 4. COLLECTOR

**STYLE 2:**

- PIN 1. ANODE
- 2. CATHODE
- 3. ANODE
- 4. CATHODE

**STYLE 3:**

- PIN 1. GATE
- 2. DRAIN
- 3. SOURCE
- 4. DRAIN

### GENERIC MARKING DIAGRAM\*

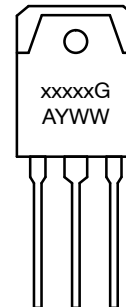

- xxxxxx = Specific Device Code
- G = Pb-Free Package
- A = Assembly Location
- Y = Year
- WW = Work Week

\*This information is generic. Please refer to device data sheet for actual part marking. Pb-Free indicator, "G", may or not be present.

<b>DOCUMENT NUMBER:</b>	<b>98AON25095D</b>	Electronic versions are uncontrolled except when accessed directly from the Document Repository. Printed versions are uncontrolled except when stamped "CONTROLLED COPY" in red.
<b>DESCRIPTION:</b>	<b>TO-3P-3LD</b>	<b>PAGE 1 OF 1</b>

ON Semiconductor and are trademarks of Semiconductor Components Industries, LLC dba ON Semiconductor or its subsidiaries in the United States and/or other countries. ON Semiconductor reserves the right to make changes without further notice to any products herein. ON Semiconductor makes no warranty, representation or guarantee regarding the suitability of its products for any particular purpose, nor does ON Semiconductor assume any liability arising out of the application or use of any product or circuit, and specifically disclaims any and all liability, including without limitation special, consequential or incidental damages. ON Semiconductor does not convey any license under its patent rights nor the rights of others.



**onsemi**, **Onsemi**, and other names, marks, and brands are registered and/or common law trademarks of Semiconductor Components Industries, LLC dba "**onsemi**" or its affiliates and/or subsidiaries in the United States and/or other countries. **onsemi** owns the rights to a number of patents, trademarks, copyrights, trade secrets, and other intellectual property. A listing of **onsemi**'s product/patent coverage may be accessed at [www.onsemi.com/site/pdf/Patent-Marking.pdf](http://www.onsemi.com/site/pdf/Patent-Marking.pdf). **onsemi** reserves the right to make changes at any time to any products or information herein, without notice. The information herein is provided "as-is" and **onsemi** makes no warranty, representation or guarantee regarding the accuracy of the information, product features, availability, functionality, or suitability of its products for any particular purpose, nor does **onsemi** assume any liability arising out of the application or use of any product or circuit, and specifically disclaims any and all liability, including without limitation special, consequential or incidental damages. Buyer is responsible for its products and applications using **onsemi** products, including compliance with all laws, regulations and safety requirements or standards, regardless of any support or applications information provided by **onsemi**. "Typical" parameters which may be provided in **onsemi** data sheets and/or specifications can and do vary in different applications and actual performance may vary over time. All operating parameters, including "Typicals" must be validated for each customer application by customer's technical experts. **onsemi** does not convey any license under any of its intellectual property rights nor the rights of others. **onsemi** products are not designed, intended, or authorized for use as a critical component in life support systems or any FDA Class 3 medical devices or medical devices with a same or similar classification in a foreign jurisdiction or any devices intended for implantation in the human body. Should Buyer purchase or use **onsemi** products for any such unintended or unauthorized application, Buyer shall indemnify and hold **onsemi** and its officers, employees, subsidiaries, affiliates, and distributors harmless against all claims, costs, damages, and expenses, and reasonable attorney fees arising out of, directly or indirectly, any claim of personal injury or death associated with such unintended or unauthorized use, even if such claim alleges that **onsemi** was negligent regarding the design or manufacture of the part. **onsemi** is an Equal Opportunity/Affirmative Action Employer. This literature is subject to all applicable copyright laws and is not for resale in any manner.

## ADDITIONAL INFORMATION

### TECHNICAL PUBLICATIONS:

Technical Library: [www.onsemi.com/design/resources/technical-documentation](http://www.onsemi.com/design/resources/technical-documentation)  
onsemi Website: [www.onsemi.com](http://www.onsemi.com)

### ONLINE SUPPORT: [www.onsemi.com/support](http://www.onsemi.com/support)

For additional information, please contact your local Sales Representative at [www.onsemi.com/support/sales](http://www.onsemi.com/support/sales)