

FAN2011/FAN2012

1.5A Low Voltage Current Mode Synchronous PWM Buck Regulator

Features

- 95% Efficiency, Synchronous Operation
- Adjustable Output Voltage from 0.8V to V_{IN}
- 4.5V to 5.5V Input Voltage Range
- Up to 1.5A Output Current
- Fixed Frequency 1.3 MHz PWM Operation
- 100% Duty Cycle Low Dropout Operation (LDO)
- Soft Start
- Excellent Load Transient Response
- 3x3mm 6-lead MLP Package

Applications

- Hard Disk Drive
- Set Top Box
- Point of Load Power
- Notebook Computers
- Communications Equipment

Description

The FAN2011/FAN2012 is a high-efficiency, low-noise synchronous Pulse Width Modulated (PWM) current mode DC-DC converter, designed for low voltage applications. It provides up to 1.5A continuous load current from the 4.5V to 5.5V input. The output voltage is adjustable over a wide range of 0.8V to V_{IN} by means of an external voltage divider.

The FAN2011 is always on, while the FAN2012 has an "Enable Input," and the device can be put in the shutdown mode, in which the ground current falls below 1 μ A.

A current mode control loop with a fast transient response ensures excellent line and load regulation. The fixed 1.3MHz switching frequency enables the user to choose a small, inexpensive external inductor and capacitor. Filtering is also easily accomplished with very small components.

Protection features include input under-voltage lockout, short circuit protection and thermal shutdown. Soft-start limits in-rush current during start-up conditions.

The device is available in a 3x3mm 6-lead MLP package, making it possible to build a 1.5A complete DC-DC converter in a tiny space on the PCB.

Ordering Information

Product Number	Output Voltage	Package Type	Ambient Operating Temperature	Order Code
FAN2011	Adjustable	3x3mm 6-Lead MLP	0°C to 85°C	FAN2011MPX
FAN2012	Adjustable	3x3mm 6-Lead MLP	0°C to 85°C	FAN2012MPX
FAN2011I	Adjustable	3x3mm 6-Lead MLP	-40°C to 85°C	FAN2011EMPX
FAN2012I	Adjustable	3x3mm 6-Lead MLP	-40°C to 85°C	FAN2012EMPX

Typical Application

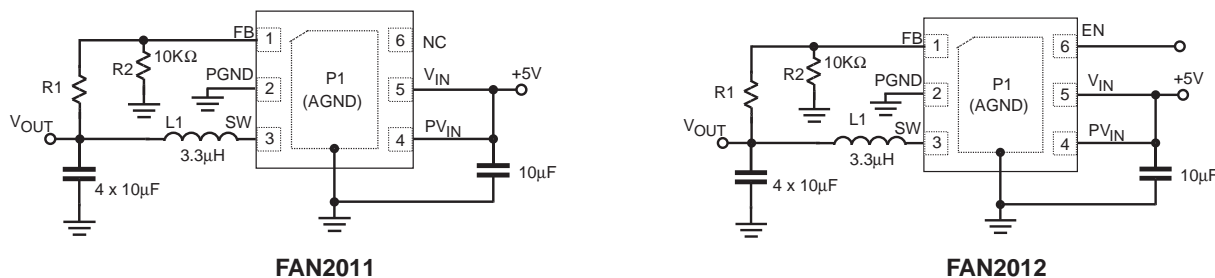

Figure 1. Typical Application

Pin Assignment

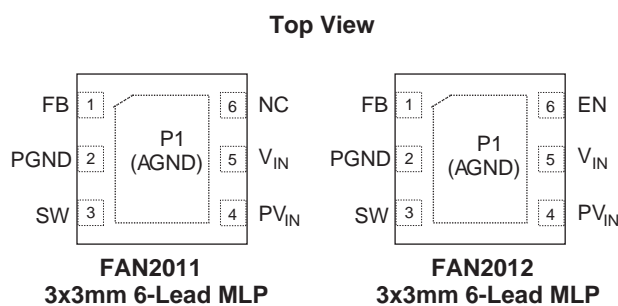

Figure 2. Pin Assignment

Pin Description

FAN2011 (3x3mm 6-Lead MLP)

Pin No.	Pin Name	Pin Description
P1	AGND	Analog Ground. P1 must be soldered to the PCB ground.
1	FB	Feedback Input. Adjustable voltage option; connect this pin to the resistor divider.
2	PGND	Power Ground. This pin is connected to the internal MOSFET switches. This pin must be externally connected to AGND.
3	SW	Switching Node. This pin is connected to the internal MOSFET switches.
4	PV _{IN}	Supply Voltage Input. This pin is connected to the internal MOSFET switches.
5	V _{IN}	Supply Voltage Input.
6	NC	Not Connected. This pin is not internally connected.

FAN2012 (3x3mm 6-Lead MLP)

Pin No.	Pin Name	Pin Description
P1	AGND	Analog Ground. P1 must be soldered to the PCB ground.
1	FB	Feedback Input. Adjustable voltage option; connect this pin to the resistor divider.
2	PGND	Power Ground. This pin is connected to the internal MOSFET switches. This pin must be externally connected to AGND.
3	SW	Switching Node. This pin is connected to the internal MOSFET switches.
4	PV _{IN}	Supply Voltage Input. This pin is connected to the internal MOSFET switches.
5	V _{IN}	Supply Voltage Input.
6	EN	Enable Input. Logic high enables the chip and logic low disables the chip, reducing the supply current to less than 1µA. Do not float this pin.

Absolute Maximum Ratings

Stresses above those listed under “Absolute Maximum Ratings” may cause permanent damage to the device. This is a stress rating only and functional operation of the device at these or any other conditions above those indicated in the operational section of this specification is not implied. Exposure to absolute maximum rating conditions for extended periods may affect device reliability. Absolute maximum ratings apply individually only, not in combination. Unless otherwise specified, all other voltages are referenced to AGND.

Parameter	Min.	Max.	Unit
V_{IN}	-0.3	7	V
PV_{IN} and any other pin	-0.3	V_{IN}	V
Thermal Resistance-Junction to Tab (θ_{JC}), 3mm x 3mm 6-lead MLP ⁽¹⁾	–	8	°C/W
Lead Soldering Temperature (10 seconds)	–	260	°C
Storage Temperature	-65	150	°C
Junction Temperature	-40	150	°C
Electrostatic Discharge (ESD) Protection Level ⁽²⁾	HBM	4	kV
	CDM	2	

Recommended Operating Conditions

Parameter	Min.	Typ.	Max.	Unit
Supply Voltage Range	4.5	–	5.5	V
Output Voltage Range, Adjustable Version	0.8	–	V_{IN}	V
Output Current	–	–	1500	mA
Inductor ⁽³⁾	–	3.3	–	μ H
Input Capacitor ⁽³⁾	–	10	–	μ F
Output Capacitor ⁽³⁾	–	4 x 10	–	μ F
Operating Ambient Temperature Range	FAN2011 and FAN2012	0	+85	°C
	FAN2011I and FAN2012I	-40	+85	

Notes:

1. Junction to ambient thermal resistance, θ_{JA} , is a strong function of PCB material, board thickness, thickness and number of copper planes, number of via used, diameter of via used, available copper surface, and attached heat sink characteristics.
2. Using Mil Std. 883E, method 3015.7(Human Body Model) and EIA/JESD22C101-A (Charge Device Model).
3. Refer to the applications section for further details.

Electrical Characteristics

$V_{IN} = 4.5V$ to $5.5V$, $V_{OUT} = 1.2V$, $I_{OUT} = 200mA$, $C_{IN} = 10\mu F$, $C_{OUT} = 4 \times 10\mu F$, $L = 3.3\mu H$, $T_A = 0^\circ C$ to $+85^\circ C$, unless otherwise noted. Typical values are at $T_A = 25^\circ C$.

Parameter	Conditions	Min.	Typ.	Max.	Units	
Input Voltage		4.5	–	5.5	V	
Quiescent Current	$I_{OUT} = 0mA$	–	7	10	mA	
UVLO Threshold	V_{IN} Rising	3.4	3.7	4	V	
	Hysteresis	–	150	–	mV	
PMOS On Resistance	$V_{IN} = V_{GS} = 5V$	–	150	290	m Ω	
NMOS On Resistance	$V_{IN} = V_{GS} = 5V$	–	150	290	m Ω	
P-channel Current Limit	$4.5V < V_{IN} < 5.5V$	2200	2600	3500	mA	
Over-Temperature Protection	Rising Temperature	–	150	–	$^\circ C$	
	Hysteresis	–	20	–	$^\circ C$	
Switching Frequency		1000	1300	1600	kHz	
Line Regulation	$V_{IN} = 4.5$ to $5.5V$, $I_{OUT} = 100mA$	–	0.16	–	%/V	
Load Regulation	$0mA \leq I_{OUT} \leq 1500mA$	–	0.2	0.5	%	
Output Voltage During Load Transition ⁽⁴⁾	I_{OUT} from 700mA to 100mA	–	–	5	%	
Output Voltage During Load Transition ⁽⁴⁾	I_{OUT} from 100mA to 700mA	-5	–	–	%	
Reverse Leakage Current Into Pin SW	$V_{IN} = \text{Open}$, $EN = \text{GND}$, $V_{SW} = 5.5V$	–	0.1	1	μA	
Reference Voltage, V_{REF}		–	0.8		V	
Output Voltage Accuracy	$V_{IN} = 4.5$ to $5.5V$ $0mA \leq I_{OUT} \leq 1500mA$	FAN2011 FAN2012	-2	–	2	%
		FAN2011I FAN2012I -40 $^\circ C$ to +85 $^\circ C$	-3	–	3	%

Notes:

4. Load transient response test waveform.

Additional Electrical Characteristics for FAN2012

$T_A = 0^\circ C$ to $+85^\circ C$, $V_{IN} = 4.5$ to $5.5V$. Typical values are at $T_A = 25^\circ C$.

Parameter	Conditions	Min.	Typ.	Max.	Units
Shutdown Mode Supply Current	$V_{EN} = 0V$	–	0.1	1	μA
EN Bias Current		–	–	0.1	μA
EN High Voltage		1.3	–	–	V
EN Low Voltage		–	–	0.4	V

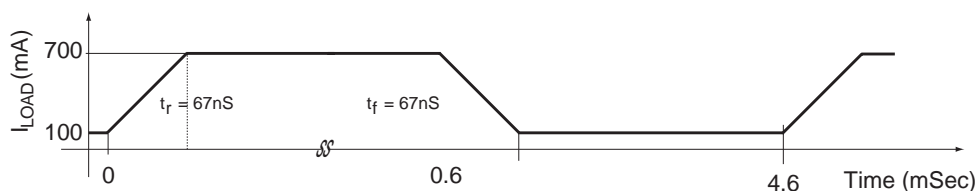
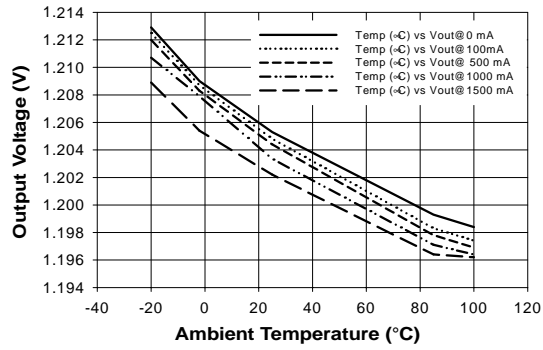

Figure 3. Load Transient Response Test Waveform

Typical Performance Characteristics

$T_A = 25^\circ\text{C}$, $C_{IN} = 10\mu\text{F}$, $C_{OUT} = 40\mu\text{F}$, $L = 3.3\mu\text{H}$, $V_{IN} = 5\text{V}$, unless otherwise noted.

Output Voltage vs. Ambient Temperature



Switching Frequency vs. Ambient Temperature

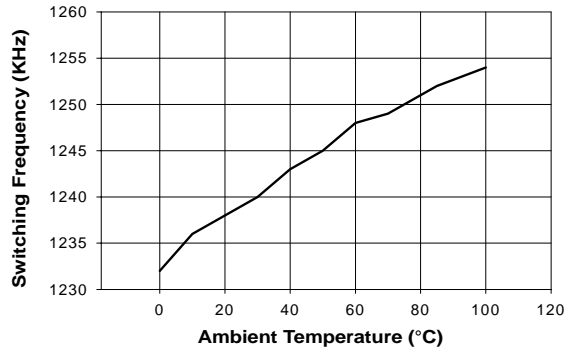

Efficiency vs. Load Current

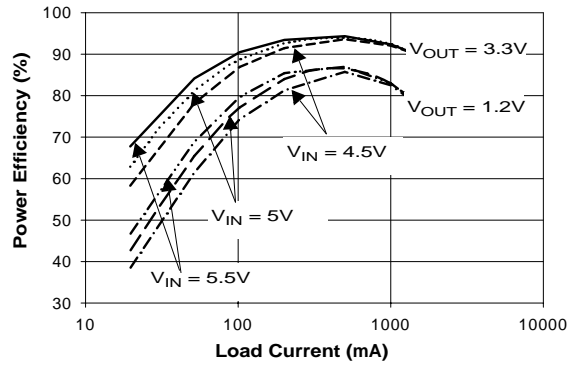

Typical Performance Characteristics (Continued)

$T_A = 25^\circ\text{C}$, $C_{IN} = 10\mu\text{F}$, $C_{OUT} = 40\mu\text{F}$, $L = 3.3\mu\text{H}$, $V_{IN} = 5\text{V}$, unless otherwise noted.

Start-up Response

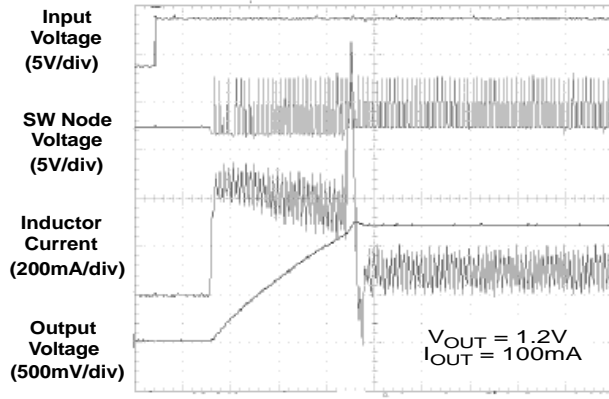

Time (50 μs /div)

Start-up Response

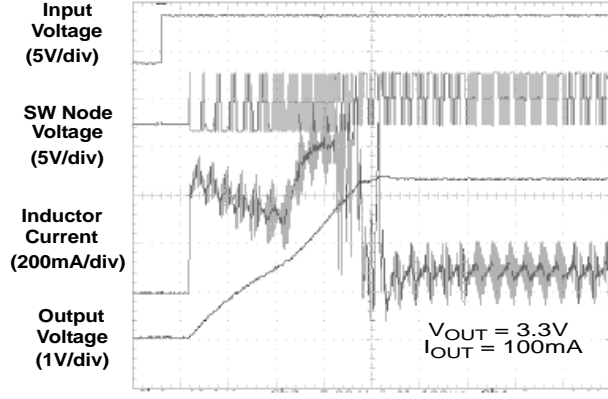

Time (100 μs /div)

Start-up Response

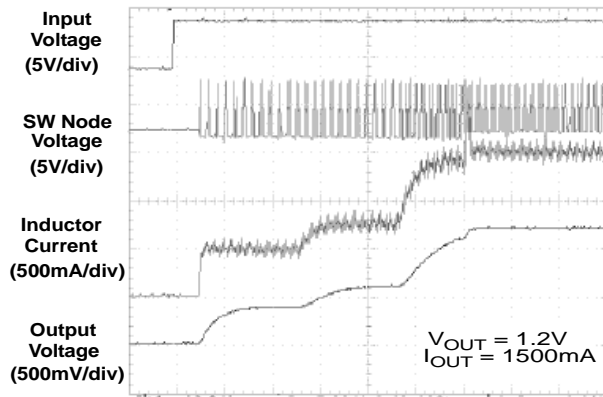

Time (100 μs /div)

Start-up Response

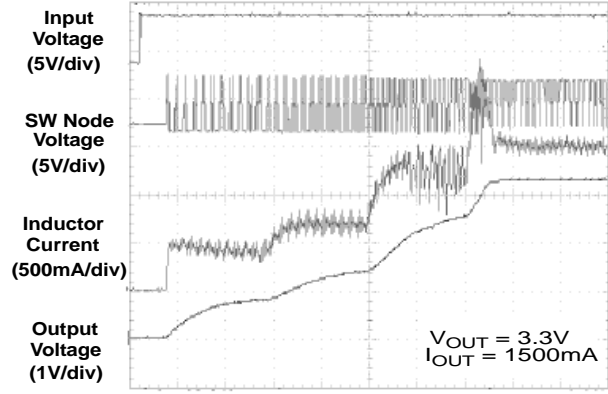

Time (100 μs /div)

Transient Response

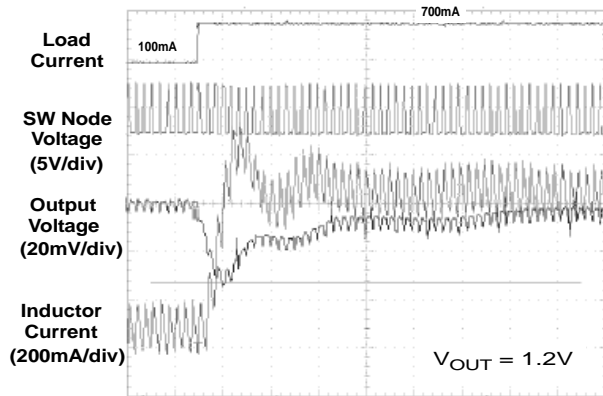

Time (5 μs /div)

Transient Response

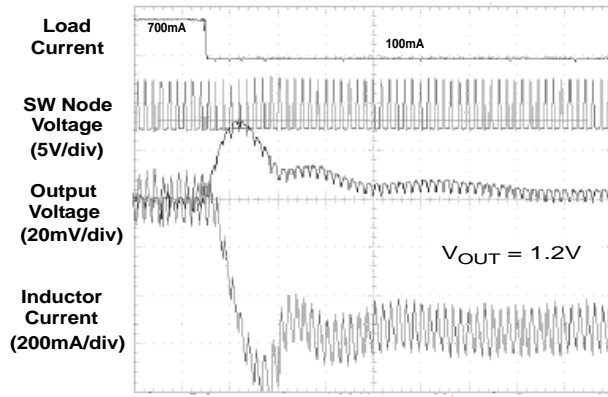

Time (5 μs /div)

Block Diagram

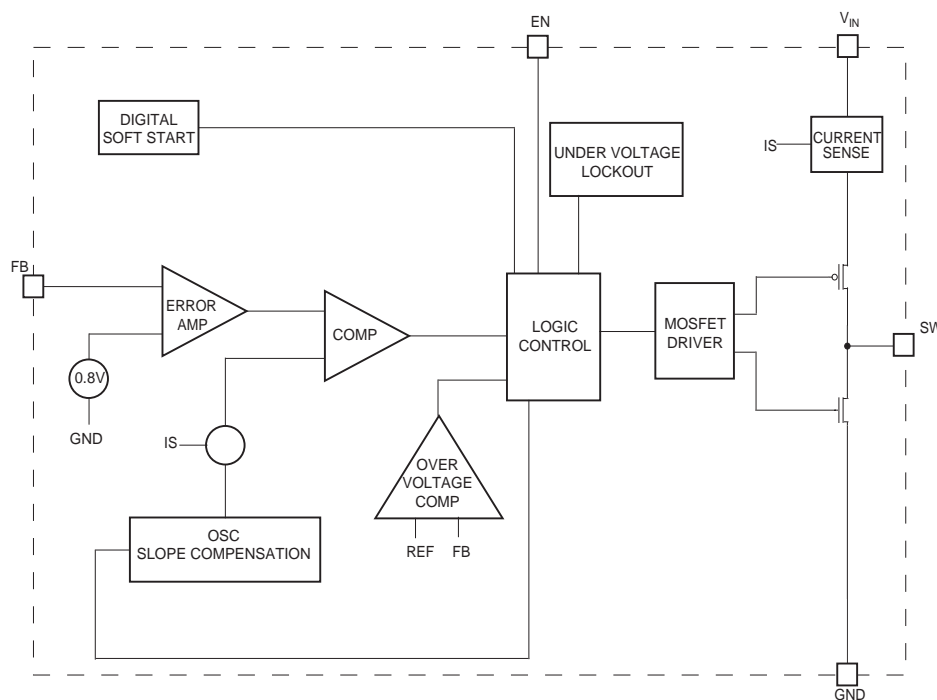

Figure 4. Block Diagram

Detailed Operation Description

The FAN2011 is a step-down pulse width modulated (PWM) current mode converter with a typical switching frequency of 1.3MHz. At the beginning of each clock cycle, the P-channel transistor is turned on. The inductor current ramps up and is monitored via an internal circuit. The P-channel switch is turned off when the sensed current causes the PWM comparator to trip when the output voltage is in regulation or when the inductor current reaches the current limit (set internally, typically 2600mA). After a minimum dead time, the N-channel transistor is turned on and the inductor current ramps down. As the clock cycle is completed, the N-channel switch is turned off and the next clock cycle starts. The duty cycle is solely given by the ratio of output voltage and input voltage. Therefore, the converter runs with a minimum duty cycle when output voltage is at minimum and input voltage is at maximum.

100% Duty Cycle Operation

As the input voltage approaches the output voltage and the duty cycle exceeds the typical 95%, the converter turns the P-channel transistor continuously on. In this mode, the output voltage is equal to the input voltage minus the voltage drop across the P-channel transistor:

$$V_{OUT} = V_{IN} - I_{LOAD} \times (R_{DS_ON} + R_L), \text{ where}$$

R_{DS_ON} = P-channel switch ON resistance

I_{LOAD} = Output current

R_L = Inductor DC resistance

UVLO and Soft Start

The reference and the circuit remain reset until the V_{IN} crosses its UVLO threshold.

The FAN2011 has an internal soft-start circuit that limits the in-rush current during start-up. This prevents possible voltage drops of the input voltage and eliminates the output voltage overshoot. The soft-start is implemented as a digital circuit, increasing the switch current in four steps to the P-channel current limit (2600mA). Typical start-up time for a 40 μ F output capacitor and a load current of 1500mA is 800 μ s.

Short Circuit Protection

The switch peak current is limited cycle by cycle to a typical value of 2600mA. In the event of an output voltage short circuit, the device operates with a frequency of 400kHz and minimum-duty cycle, therefore the average input current is typically 350mA.

Thermal Shutdown

When the die temperature exceeds 150 $^{\circ}$ C, a reset occurs and remains in effect until the die cools to 130 $^{\circ}$ C, at which point, the circuit restarts.

Applications Information

Setting the Output Voltage

The internal reference is 0.8V. The output is divided down by a voltage divider, R1 and R2 to the FB pin. The output voltage is:

$$V_{OUT} = V_{REF} \left(1 + \frac{R_1}{R_2} \right)$$

According to this equation, and assuming desired output voltage of 1.5096V, and given R2 = 10KΩ, the calculated value of R1 is 8.87KΩ.

Inductor Selection

The inductor parameters directly related to device performances are saturation current and DC resistance. The FAN2011/FAN2012 operates with a typical inductor value of 3.3μH. The lower the dc resistance, the higher the efficiency. For saturation current, the inductor should be rated higher than the maximum load current, plus half of the inductor ripple current calculated as follows:

$$\Delta I_L = V_{OUT} \times \frac{1 - (V_{OUT}/V_{IN})}{L \times f}$$

where:

ΔI_L = Inductor Ripple Current

f = Switching Frequency

L = Inductor Value

Some recommended inductors are suggested in the table below:

Table 1. Recommended Inductors

Inductor Value	Vendor	Part Number
3.3μH	Panasonic	ELL6PM3R3N
3.3μH	Murata	LQS66C3R3M04
3.3μH	Coiltronics	SD-3R3-R

Capacitors Selection

For best performances, a low ESR input capacitor is required. A ceramic capacitor of at least 10μF, placed as close to the V_{IN} and AGND pins of the device is recommended. The output capacitor determines the output ripple and the transient response.

Table 2. Recommended Capacitors

Capacitor Value	Vendor	Part Number
10μF	Taiyo Yuden	JMK212BJ106MG
		JMK316BJ106KL
	TDK	C2012X5ROJ106K
		C3216X5ROJ106M
	Murata	GRM32ER61C106K

PCB Layout Recommendations

The inherently high peak currents and switching frequency of power supplies require a careful PCB layout design. Therefore, use wide traces for high-current paths and place the input capacitor, the inductor, and the output capacitor as close as possible to the integrated circuit terminals. To minimize voltage stress to the device resulting from ever-present switching spikes, use an input bypass capacitor with low ESR. Use of an external Schottky diode, with its anode connected to SW node and cathode connected to PV_{IN}, further reduces switching spikes. Note that the peak amplitude of the switching spikes depends upon the load current; the higher the load current, the higher the switching spikes.

The resistor divider that sets the output voltage should be routed away from the inductor to avoid RF coupling. The ground plane at the bottom side of the PCB acts as an electromagnetic shield to reduce EMI. The recommended PCB layout is shown below in Figure 5.

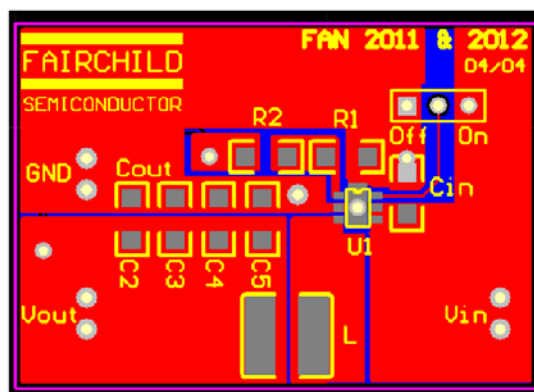
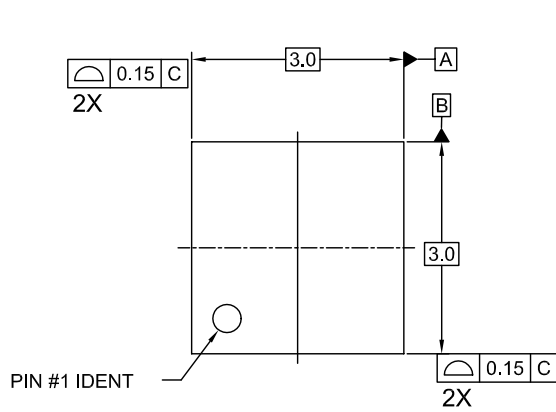

Figure 5. Recommended PCB Layout

Mechanical Dimensions

3x3mm 6-Lead MLP



TOP VIEW

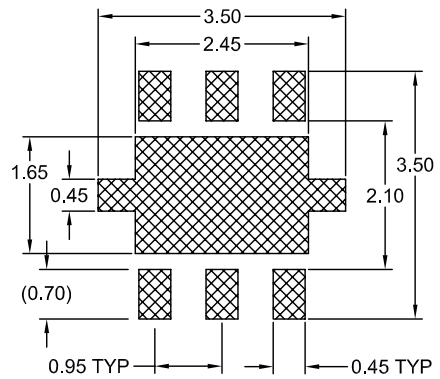

RECOMMENDED LAND PATTERN

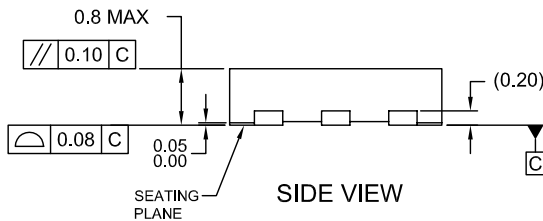

SIDE VIEW

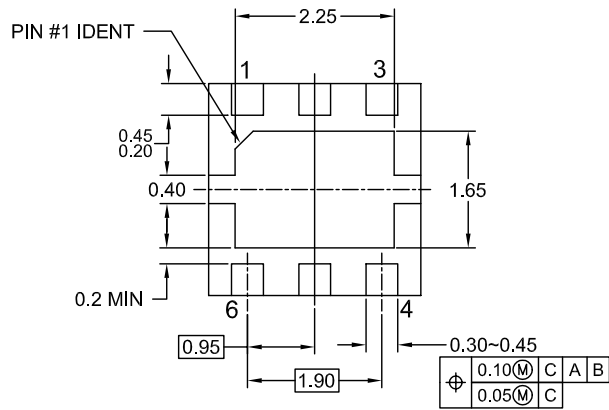

BOTTOM VIEW

NOTES:

- A. CONFORMS TO JEDEC REGISTRATION MO-229, VARIATION WEEA, DATED 11/2001 EXCEPT FOR DAP EXTENSION TABS
- B. DIMENSIONS ARE IN MILLIMETERS.
- C. DIMENSIONS AND TOLERANCES PER ASME Y14.5M, 1994

MLP06FrevA

TRADEMARKS

The following are registered and unregistered trademarks Fairchild Semiconductor owns or is authorized to use and is not intended to be an exhaustive list of all such trademarks.

ACEx™	FAST®	ISOPLANAR™	PowerSaver™	SuperSOT™-6
ActiveArray™	FASTr™	LittleFET™	PowerTrench®	SuperSOT™-8
Bottomless™	FPST™	MICROCOUPLER™	QFET®	SyncFET™
Build it Now™	FRFET™	MicroFET™	QS™	TCM™
CoolFET™	GlobalOptoisolator™	MicroPak™	QT Optoelectronics™	TinyLogic®
CROSSVOLT™	GTO™	MICROWIRE™	Quiet Series™	TINYOPTO™
DOME™	HiSeC™	MSX™	RapidConfigure™	TruTranslation™
EcoSPARK™	I ² C™	MSXPro™	RapidConnect™	UHC™
E ² CMOS™	i-Lo™	OCX™	μSerDes™	UltraFET®
EnSigna™	ImpliedDisconnect™	OCXPro™	ScalarPump™	UniFET™
FACT™	IntelliMAX™	OPTOLOGIC®	SILENT SWITCHER®	VCX™
FACT Quiet Series™		OPTOPLANAR™	SMART START™	Wire™
Across the board. Around the world.™		PACMAN™	SPM™	
The Power Franchise®		POP™	Stealth™	
Programmable Active Droop™		Power247™	SuperFET™	
		PowerEdge™	SuperSOT™-3	

DISCLAIMER

FAIRCHILD SEMICONDUCTOR RESERVES THE RIGHT TO MAKE CHANGES WITHOUT FURTHER NOTICE TO ANY PRODUCTS HEREIN TO IMPROVE RELIABILITY, FUNCTION OR DESIGN. FAIRCHILD DOES NOT ASSUME ANY LIABILITY ARISING OUT OF THE APPLICATION OR USE OF ANY PRODUCT OR CIRCUIT DESCRIBED HEREIN; NEITHER DOES IT CONVEY ANY LICENSE UNDER ITS PATENT RIGHTS, NOR THE RIGHTS OF OTHERS.

LIFE SUPPORT POLICY

FAIRCHILD'S PRODUCTS ARE NOT AUTHORIZED FOR USE AS CRITICAL COMPONENTS IN LIFE SUPPORT DEVICES OR SYSTEMS WITHOUT THE EXPRESS WRITTEN APPROVAL OF FAIRCHILD SEMICONDUCTOR CORPORATION. As used herein:

1. Life support devices or systems are devices or systems which, (a) are intended for surgical implant into the body, or (b) support or sustain life, or (c) whose failure to perform when properly used in accordance with instructions for use provided in the labeling, can be reasonably expected to result in significant injury to the user.
2. A critical component is any component of a life support device or system whose failure to perform can be reasonably expected to cause the failure of the life support device or system, or to affect its safety or effectiveness.

PRODUCT STATUS DEFINITIONS

Definition of Terms

Datasheet Identification	Product Status	Definition
Advance Information	Formative or In Design	This datasheet contains the design specifications for product development. Specifications may change in any manner without notice.
Preliminary	First Production	This datasheet contains preliminary data, and supplementary data will be published at a later date. Fairchild Semiconductor reserves the right to make changes at any time without notice in order to improve design.
No Identification Needed	Full Production	This datasheet contains final specifications. Fairchild Semiconductor reserves the right to make changes at any time without notice in order to improve design.
Obsolete	Not In Production	This datasheet contains specifications on a product that has been discontinued by Fairchild semiconductor. The datasheet is printed for reference information only.

Rev. 118