

## 74VCXH16374

### Low Voltage 16-Bit D-Type Flip-Flops with Bushold

#### General Description

The VCXH16374 contains sixteen non-inverting D-type flip-flops with 3-STATE outputs and is intended for bus oriented applications. The device is byte controlled. A buffered clock (CP) and output enable (OE) are common to each byte and can be shorted together for full 16-bit operation.

The VCXH16374 data inputs include active bushold circuitry, eliminating the need for external pull-up resistors to hold unused or floating data inputs at a valid logic level.

The 74VCXH16374 is designed for low voltage (1.4V to 3.6V)  $V_{CC}$  applications with output compatibility up to 3.6V.

The 74VCXH16374 is fabricated with an advanced CMOS technology to achieve high speed operation while maintaining low CMOS power dissipation.

#### Features

- 1.4V to 3.6V  $V_{CC}$  supply operation
- 3.6V tolerant control inputs and outputs
- Bushold on data inputs eliminates the need for external pull-up/pull-down resistors
- $t_{PD}$   
3.0 ns max for 3.0V to 3.6V  $V_{CC}$
- Static Drive ( $I_{OH}/I_{OL}$ )  
 $\pm 24$  mA @ 3.0V  $V_{CC}$
- Uses proprietary noise/EMI reduction circuitry
- Latch-up performance exceeds 300 mA
- ESD performance:  
Human body model > 2000V  
Machine model > 200V
- Also packaged in plastic Fine-Pitch Ball Grid Array (FBGA) (Preliminary)

#### Ordering Code:

Order Number	Package Number	Package Descriptions
74VCXH16374GX (Note 1)	BGA54A (Preliminary)	54-Ball Fine-Pitch Ball Grid Array (FBGA), JEDEC MO-205, 5.5mm Wide [TAPE and REEL]
74VCXH16374MTD (Note 2)	MTD48	48-Lead Thin Shrink Small Outline Package (TSSOP), JEDEC MO-153, 6.1mm Wide

**Note 1:** BGA package available in Tape and Reel only.

**Note 2:** Devices also available in Tape and Reel. Specify by appending suffix letter "X" to the ordering code.

#### Logic Symbol

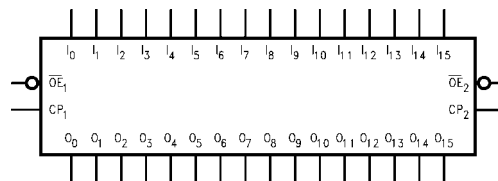

### Connection Diagrams

Pin Assignment for TSSOP

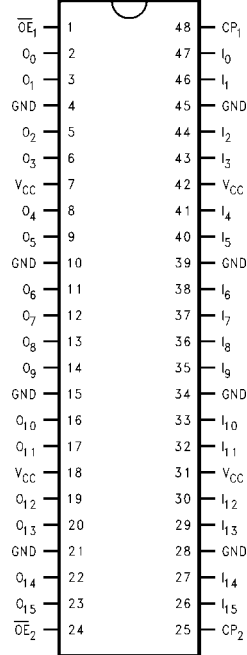

Pin Assignment for FBGA

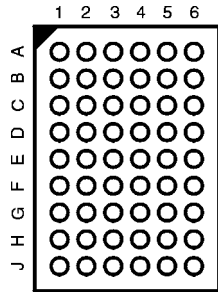

(Top Thru View)

### Pin Descriptions

Pin Names	Description
$\overline{OE}_n$	Output Enable Input (Active LOW)
CP <sub>n</sub>	Clock Pulse Input
I <sub>0</sub> -I <sub>15</sub>	Bushold Inputs
O <sub>0</sub> -O <sub>15</sub>	Outputs
NC	No Connect

### FBGA Pin Assignments

	1	2	3	4	5	6
A	O <sub>0</sub>	NC	$\overline{OE}_1$	CP <sub>1</sub>	NC	I <sub>0</sub>
B	O <sub>2</sub>	O <sub>1</sub>	NC	NC	I <sub>1</sub>	I <sub>2</sub>
C	O <sub>4</sub>	O <sub>3</sub>	V <sub>CC</sub>	V <sub>CC</sub>	I <sub>3</sub>	I <sub>4</sub>
D	O <sub>6</sub>	O <sub>5</sub>	GND	GND	I <sub>5</sub>	I <sub>6</sub>
E	O <sub>8</sub>	O <sub>7</sub>	GND	GND	I <sub>7</sub>	I <sub>8</sub>
F	O <sub>10</sub>	O <sub>9</sub>	GND	GND	I <sub>9</sub>	I <sub>10</sub>
G	O <sub>12</sub>	O <sub>11</sub>	V <sub>CC</sub>	V <sub>CC</sub>	I <sub>11</sub>	I <sub>12</sub>
H	O <sub>14</sub>	O <sub>13</sub>	NC	NC	I <sub>13</sub>	I <sub>14</sub>
J	O <sub>15</sub>	NC	$\overline{OE}_2$	CP <sub>2</sub>	NC	I <sub>15</sub>

### Truth Tables

Inputs			Outputs
CP <sub>1</sub>	$\overline{OE}_1$	I <sub>0</sub> -I <sub>7</sub>	O <sub>0</sub> -O <sub>7</sub>
↗	L	H	H
↗	L	L	L
L	L	X	O <sub>0</sub>
X	H	X	Z

Inputs			Outputs
CP <sub>2</sub>	$\overline{OE}_2$	I <sub>8</sub> -I <sub>15</sub>	O <sub>8</sub> -O <sub>15</sub>
↗	L	H	H
↗	L	L	L
L	L	X	O <sub>0</sub>
X	H	X	Z

H = HIGH Voltage Level  
 L = LOW Voltage Level  
 X = Immaterial (HIGH or LOW, control inputs may not float)  
 Z = High Impedance  
 O<sub>0</sub> = Previous O<sub>0</sub> before HIGH-to-LOW of CP

## Functional Description

The 74VCXH16374 consists of sixteen edge-triggered flip-flops with individual D-type inputs and 3-STATE true outputs. The device is byte controlled with each byte functioning identically, but independent of the other. The control pins can be shorted together to obtain full 16-bit operation. Each clock has a buffered clock and buffered Output Enable common to all flip-flops within that byte. The description which follows applies to each byte. Each

flip-flop will store the state of their individual I inputs that meet the setup and hold time requirements on the LOW-to-HIGH Clock ( $CP_n$ ) transition. With the Output Enable ( $\overline{OE}_n$ ) LOW, the contents of the flip-flops are available at the outputs. When  $\overline{OE}_n$  is HIGH, the outputs go to the high impedance state. Operations of the  $\overline{OE}_n$  input does not affect the state of the flip-flops.

## Logic Diagram

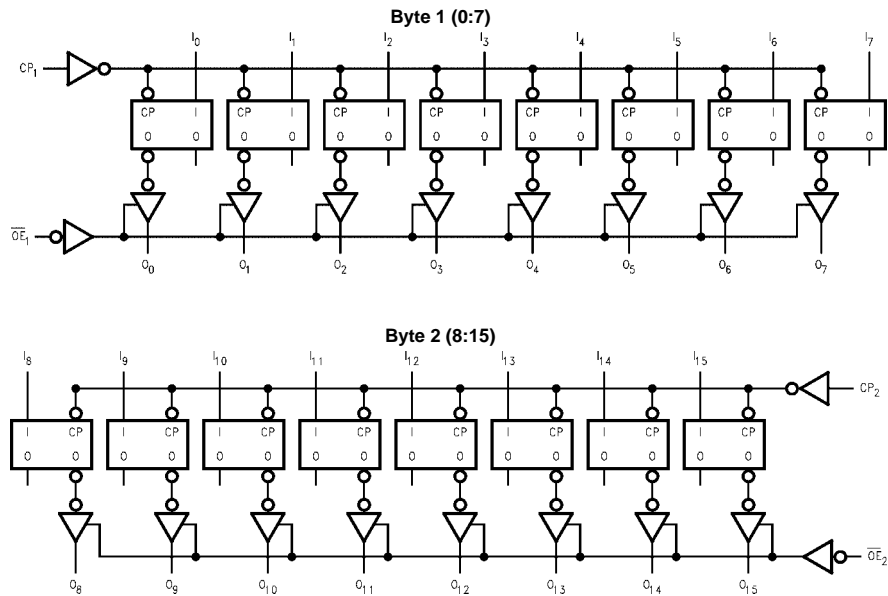

Please note that this diagram is provided only for the understanding of logic operations and should not be used to estimate propagation delays.

**Absolute Maximum Ratings** (Note 3)

Supply Voltage ( $V_{CC}$ )	-0.5V to +4.6V
DC Input Voltage ( $V_I$ )	-0.5V to 4.6V
$\overline{OE}_n, CP_n$	-0.5V to 4.6V
$I_0 - I_{15}$	-0.5V to $V_{CC} + 0.5V$
Output Voltage ( $V_O$ )	
Outputs 3-STATED	-0.5V to +4.6V
Outputs Active (Note 4)	-0.5V to $V_{CC} + 0.5V$
DC Input Diode Current ( $I_{IK}$ )	
$V_I < 0V$	-50 mA
DC Output Diode Current ( $I_{OK}$ )	
$V_O < 0V$	-50 mA
$V_O > V_{CC}$	+50 mA
DC Output Source/Sink Current ( $I_{OH}/I_{OL}$ )	$\pm 50$ mA
DC $V_{CC}$ or GND Current per Supply Pin ( $I_{CC}$ or GND)	$\pm 100$ mA
Storage Temperature Range ( $T_{STG}$ )	-65°C to +150°C

**Recommended Operating Conditions** (Note 5)

Power Supply	
Operating	1.4V to 3.6V
Input Voltage	-0.3V to $V_{CC}$
Output Voltage ( $V_O$ )	
Output in Active States	0V to $V_{CC}$
Output in "OFF" State	0.0V to 3.6V
Output Current in $I_{OH}/I_{OL}$	
$V_{CC} = 3.0V$ to 3.6V	$\pm 24$ mA
$V_{CC} = 2.3V$ to 2.7V	$\pm 18$ mA
$V_{CC} = 1.65V$ to 2.3V	$\pm 6$ mA
$V_{CC} = 1.4V$ to 1.6V	$\pm 2$ mA
Free Air Operating Temperature ( $T_A$ )	-40°C to +85°C
Minimum Input Edge Rate ( $\Delta t/\Delta V$ )	
$V_{IN} = 0.8V$ to 2.0V, $V_{CC} = 3.0V$	10 ns/V

**Note 3:** The Absolute Maximum Ratings are those values beyond which the safety of the device cannot be guaranteed. The device should not be operated at these limits. The parametric values defined in the Electrical Characteristics tables are not guaranteed at the Absolute Maximum Ratings. The "Recommended Operating Conditions" table will define the conditions for actual device operation.

**Note 4:**  $I_O$  Absolute Maximum Rating must be observed.

**Note 5:** Floating or unused control inputs must be held HIGH or LOW.

**DC Electrical Characteristics**

Symbol	Parameter	Conditions	$V_{CC}$ (V)	Min	Max	Units	
$V_{IH}$	HIGH Level Input Voltage		2.7 - 3.6	2.0		V	
			2.3 - 2.7	1.6			
			1.65 - 2.3	$0.65 \times V_{CC}$			
			1.4 - 1.6	$0.65 \times V_{CC}$			
$V_{IL}$	LOW Level Input Voltage		2.7 - 3.6		0.8	V	
			2.3 - 2.7		0.7		
			1.65 - 2.3		$1.35 \times V_{CC}$		
			1.4 - 1.6		$1.35 \times V_{CC}$		
$V_{OH}$	HIGH Level Output Voltage	$I_{OH} = -100 \mu A$	2.7 - 3.6	$V_{CC} - 0.2$		V	
			$I_{OH} = -12$ mA	2.7	2.2		
			$I_{OH} = -18$ mA	3.0	2.4		
			$I_{OH} = -24$ mA	3.0	2.2		
		$I_{OH} = -100 \mu A$	2.3 - 2.7	$V_{CC} - 0.2$			
			$I_{OH} = -6$ mA	2.3	2.0		
			$I_{OH} = -12$ mA	2.3	1.8		
			$I_{OH} = -18$ mA	2.3	1.7		
		$I_{OH} = -100 \mu A$	1.65 - 2.3	$V_{CC} - 0.2$			
			$I_{OH} = -6$ mA	1.65	1.25		
			$I_{OH} = -100 \mu A$	1.4 - 1.6	$V_{CC} - 0.2$		
			$I_{OH} = -2$ mA	1.4	1.05		

DC Electrical Characteristics (Continued)							
Symbol	Parameter		Conditions	V <sub>CC</sub> (V)	Min	Max	Units
V <sub>OL</sub>	LOW Level Output Voltage		I <sub>OL</sub> = 100 μA	2.7 - 3.6		0.2	V
			I <sub>OL</sub> = 12 mA	2.7		0.4	
			I <sub>OL</sub> = 18 mA	3.0		0.4	
			I <sub>OL</sub> = 24 mA	3.0		0.55	
			I <sub>OL</sub> = 100 μA	2.3 - 2.7		0.2	
			I <sub>OL</sub> = 12 mA	2.3		0.4	
			I <sub>OL</sub> = 18 mA	2.3		0.6	
			I <sub>OL</sub> = 100 μA	1.65 - 2.3		0.2	
			I <sub>OL</sub> = 6 mA	1.65		0.3	
			I <sub>OL</sub> = 100 μA	1.4 - 1.6		0.2	
			I <sub>OL</sub> = 2 mA	1.4		0.35	
I <sub>I</sub>	Input Leakage Current	Control Pins	0 ≤ V <sub>I</sub> ≤ 3.6V	2.7 - 3.6		±5.0	μA
		Data Pins	V <sub>I</sub> = V <sub>CC</sub> or GND	2.7 - 3.6		±5.0	
I <sub>I(HOLD)</sub>	Bushold Input Minimum Drive Hold Current		V <sub>IN</sub> = 0.8V	3.0	75.0		μA
			V <sub>IN</sub> = 2.0V	3.0	-75.0		
			V <sub>IN</sub> = 0.7V	2.3	45.0		
			V <sub>IN</sub> = 1.6V	2.3	-45.0		
			V <sub>IN</sub> = 0.57V	1.65	25.0		
			V <sub>IN</sub> = 1.07V	1.65	-25.0		
I <sub>I(OD)</sub>	Bushold Input Over-Drive Current to Change State		(Note 6)	3.6	450		μA
			(Note 7)	3.6	-450		
			(Note 6)	2.7	300		
			(Note 7)	2.7	-300		
			(Note 6)	1.95	200		
			(Note 7)	1.95	-200		
I <sub>OZ</sub>	3-STATE Output Leakage		0 ≤ V <sub>O</sub> ≤ 3.6V V <sub>I</sub> = V <sub>IH</sub> or V <sub>IL</sub>	1.4 - 3.6		±10.0	μA
I <sub>OFF</sub>	Power-OFF Leakage Current		0 ≤ (V <sub>O</sub> ) ≤ 3.6V	0		10.0	μA
I <sub>CC</sub>	Quiescent Supply Current		V <sub>I</sub> = V <sub>CC</sub> or GND	1.4 - 3.6		20.0	μA
			V <sub>CC</sub> ≤ (V <sub>O</sub> ) ≤ 3.6V (Note 8)	1.4 - 3.6		±20.0	μA
ΔI <sub>CC</sub>	Increase in I <sub>CC</sub> per Input		V <sub>IH</sub> = V <sub>CC</sub> - 0.6V	2.7 - 3.6		750	μA

**Note 6:** An external driver must source at least the specified current to switch from LOW-to-HIGH.  
**Note 7:** An external driver must sink at least the specified current to switch from HIGH-to-LOW.  
**Note 8:** Outputs disabled or 3-STATE only.

AC Electrical Characteristics (Note 9)							
Symbol	Parameter	Conditions	V <sub>CC</sub> (V)	T <sub>A</sub> = -40°C to +85°C		Units	Figure Number
				Min	Max		
f <sub>MAX</sub>	Maximum Clock Frequency	C <sub>L</sub> = 30 pF	3.3 ± 0.3	250		MHz	
			2.5 ± 0.2	200			
			1.8 ± 0.15	100			
		C <sub>L</sub> = 15 pF	1.5 ± 0.1	80.0			
t <sub>PHL</sub> t <sub>PLH</sub>	Propagation Delay	C <sub>L</sub> = pF, R <sub>L</sub> = 500Ω	3.3 ± 0.3	0.8	3.0	ns	Figures 1, 2
			2.5 ± 0.2	1.0	3.9		
			1.8 ± 0.15	1.5	7.8		Figures 7, 8
		C <sub>L</sub> = 15 pF, R <sub>L</sub> = 2 kΩ	1.5 ± 0.1	1.0	15.6		
t <sub>PZL</sub> t <sub>PZH</sub>	Output Enable Time	C <sub>L</sub> = 30 pF, R <sub>L</sub> = 500Ω	3.3 ± 0.3	0.8	3.5	ns	Figures 1, 3, 4
			2.5 ± 0.2	1.0	4.6		
			1.8 ± 0.15	1.5	9.2		Figures 7, 9, 10
		C <sub>L</sub> = 15 pF, R <sub>L</sub> = 2 kΩ	1.5 ± 0.1	1.0	18.4		
t <sub>PLZ</sub>	Output Disable Time	C <sub>L</sub> = 30 pF, R <sub>L</sub> = 500Ω	3.3 ± 0.3	0.8	3.5	ns	Figures 1, 3, 4
			2.5 ± 0.2	1.0	3.8		
			1.8 ± 0.15	1.5	6.8		Figures 7, 9, 10
		C <sub>L</sub> = 15 pF, R <sub>L</sub> = 2 kΩ	1.5 ± 0.1	1.0	13.6		
t <sub>S</sub>	Setup Time	C <sub>L</sub> = 30 pF, R <sub>L</sub> = 500Ω	3.3 ± 0.3	1.5		ns	Figure 6
			2.5 ± 0.2	1.5			
			1.8 ± 0.15	2.5			
		C <sub>L</sub> = 15 pF, R <sub>L</sub> = 500Ω	1.5 ± 0.1	3.0			
t <sub>H</sub>	Hold Time	C <sub>L</sub> = 30 pF, R <sub>L</sub> = 500Ω	3.3 ± 0.3	1.0		ns	Figure 6
			2.5 ± 0.2	1.0			
			1.8 ± 0.15	1.0			
		C <sub>L</sub> = 15 pF, R <sub>L</sub> = 500Ω	1.5 ± 0.1	2.0			
t <sub>W</sub>	Pulse Width	C <sub>L</sub> = 30 pF, R <sub>L</sub> = 500Ω	3.3 ± 0.3	1.5		ns	Figure 5
			2.5 ± 0.2	1.5			
			1.8 ± 0.15	4.0			
		C <sub>L</sub> = 15 pF, R <sub>L</sub> = 500Ω	1.5 ± 0.1	4.0			
t <sub>OSSL</sub> t <sub>OSSLH</sub>	Output to Output Skew (Note 10)	C <sub>L</sub> = 30 pF, R <sub>L</sub> = 500Ω	3.3 ± 0.3		0.5	ns	
			2.5 ± 0.2		0.5		
			1.8 ± 0.15		0.75		
		C <sub>L</sub> = 15 pF, R <sub>L</sub> = 2 kΩ	1.5 ± 0.1		1.5		

**Note 9:** For C<sub>L</sub> = 50 pF, add approximately 300 ps to the AC maximum specification.

**Note 10:** Skew is defined as the absolute value of the difference between the actual propagation delay for any two separate outputs of the same device. The specification applies to any outputs switching in the same direction, either HIGH-to-LOW (t<sub>OSSL</sub>) or LOW-to-HIGH (t<sub>OSSLH</sub>).

Dynamic Switching Characteristics					
Symbol	Parameter	Conditions	V <sub>CC</sub> (V)	T <sub>A</sub> = +25°C	Units
				Typical	
V <sub>OLP</sub>	Quiet Output Dynamic Peak V <sub>OL</sub>	C <sub>L</sub> = 30 pF, V <sub>IH</sub> = V <sub>CC</sub> , V <sub>IL</sub> = 0V	1.8	0.25	V
			2.5	0.6	
			3.3	0.8	
V <sub>OLV</sub>	Quiet Output Dynamic Valley V <sub>OL</sub>	C <sub>L</sub> = 30 pF, V <sub>IH</sub> = V <sub>CC</sub> , V <sub>IL</sub> = 0V	1.8	-0.25	V
			2.5	-0.6	
			3.3	-0.8	
V <sub>OHV</sub>	Quiet Output Dynamic Valley V <sub>OH</sub>	C <sub>L</sub> = 30 pF, V <sub>IH</sub> = V <sub>CC</sub> , V <sub>IL</sub> = 0V	1.8	1.5	V
			2.5	1.9	
			3.3	2.2	
Capacitance					
Symbol	Parameter	Conditions	T <sub>A</sub> = +25°C		Units
			Typical		
C <sub>IN</sub>	Input Capacitance	V <sub>CC</sub> = 1.8V, 2.5V or 3.3V, V <sub>I</sub> = 0V or V <sub>CC</sub>	6.0		pF
C <sub>OUT</sub>	Output Capacitance	V <sub>I</sub> = 0V or V <sub>CC</sub> , V <sub>CC</sub> = 1.8V, 2.5V or 3.3V	7.0		pF
C <sub>PD</sub>	Power Dissipation Capacitance	V <sub>I</sub> = 0V or V <sub>CC</sub> , f = 10 MHz, V <sub>CC</sub> = 1.8V, 2.5V or 3.3V	20.0		pF

**AC Loading and Waveforms ( $V_{CC}$  3.3V ± 0.3V to 1.8V ± 0.15V)**

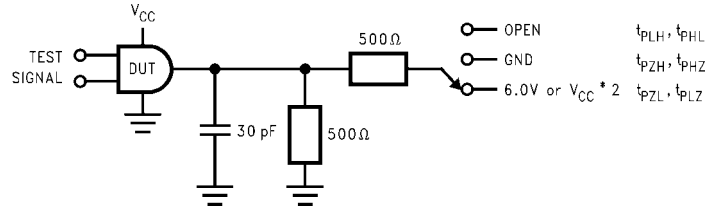

TEST	SWITCH
$t_{PLH}, t_{PHL}$	Open
$t_{PZL}, t_{PLZ}$	6V at $V_{CC} = 3.3V \pm 0.3V$ ; $V_{CC} * 2$ at $V_{CC} = 2.5V \pm 0.2V; 1.8V \pm 0.15V$
$t_{PZH}, t_{PHZ}$	GND

FIGURE 1. AC Test Circuit

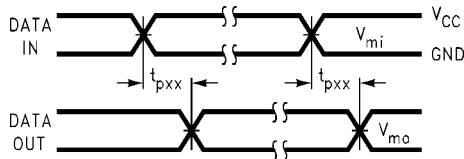

FIGURE 2. Waveform for Inverting and Non-Inverting Functions

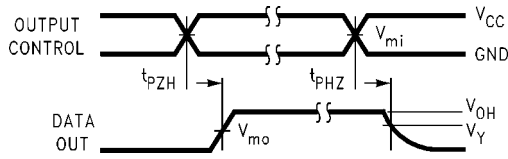

FIGURE 3. 3-STATE Output High Enable and Disable Times for Low Voltage Logic

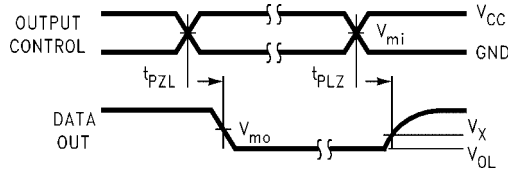

FIGURE 4. 3-STATE Output Low Enable and Disable Times for Low Voltage Logic

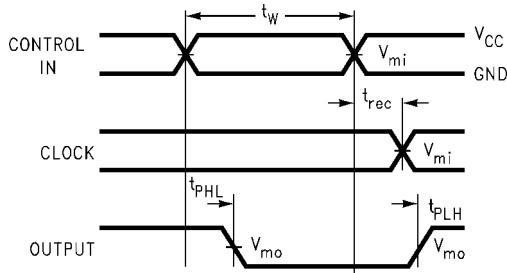

FIGURE 5. Propagation Delay, Pulse Width and  $t_{REC}$  Waveforms

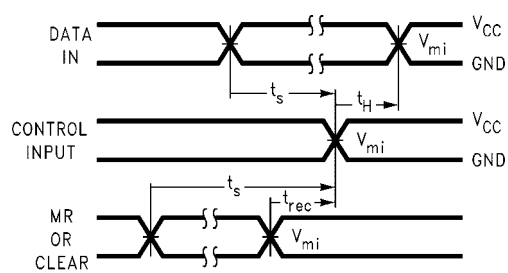
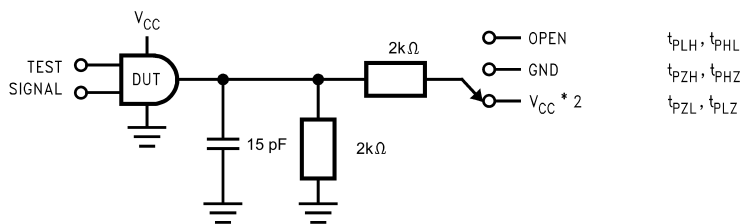

FIGURE 6. Setup Time, Hold Time and Recovery Time for Low Voltage Logic

Symbol	$V_{CC}$		
	3.3V ± 0.3V	2.5V ± 0.2V	1.8V ± 0.15V
$V_{mi}$	1.5V	$V_{CC}/2$	$V_{CC}/2$
$V_{mo}$	1.5V	$V_{CC}/2$	$V_{CC}/2$
$V_X$	$V_{OL} + 0.3V$	$V_{OL} + 0.15V$	$V_{OL} + 0.15V$
$V_Y$	$V_{OH} - 0.3V$	$V_{OH} - 0.15V$	$V_{OH} - 0.15V$



**AC Loading and Waveforms ( $V_{CC} 1.5V \pm 0.1V$ )**



TEST	SWITCH
$t_{PLH}, t_{PHL}$	Open
$t_{PZL}, t_{PLZ}$	$V_{CC} \times 2$ at $V_{CC} = 1.5 \pm 0.1V$
$t_{PZH}, t_{PHZ}$	GND

**FIGURE 7. AC Test Circuit**

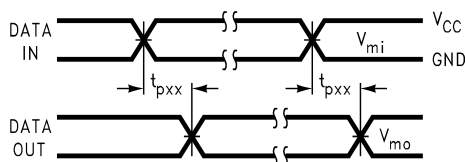

**FIGURE 8. Waveform for Inverting and Non-Inverting Functions**

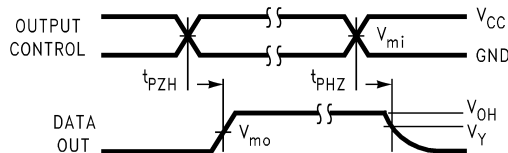

**FIGURE 9. 3-STATE Output High Enable and Disable Times for Low Voltage Logic**

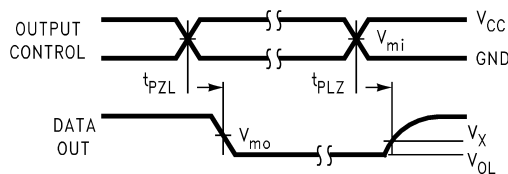

**FIGURE 10. 3-STATE Output Low Enable and Disable Times for Low Voltage Logic**

Symbol	$V_{CC}$
	$1.5V \pm 0.1V$
$V_{mi}$	$V_{CC}/2$
$V_{mo}$	$V_{CC}/2$
$V_x$	$V_{OL} + 0.1V$
$V_y$	$V_{OH} - 0.1V$

**Physical Dimensions** inches (millimeters) unless otherwise noted

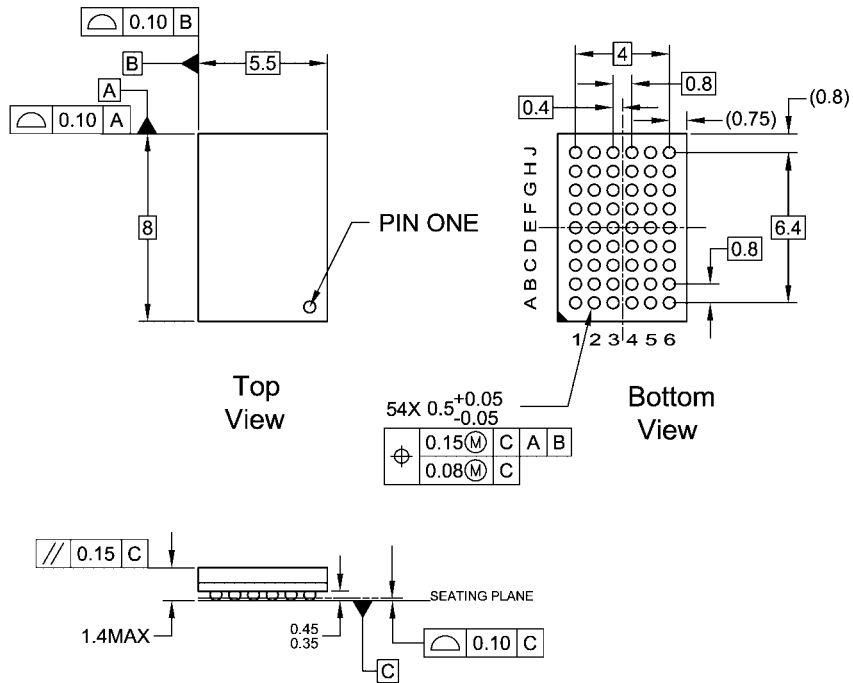

**NOTES:**

- A. THIS PACKAGE CONFORMS TO JEDEC MO-205
- B. ALL DIMENSIONS IN MILLIMETERS
- C. LAND PATTERN RECOMMENDATION: NSMD (Non Solder Mask Defined)  
.35MM DIA PADS WITH A SOLDERMASK OPENING OF .45MM CONCENTRIC TO PADS
- D. DRAWING CONFORMS TO ASME Y14.5M-1994

BGA54ArevD

**54-Ball Fine-Pitch Ball Grid Array (FBGA), JEDEC MO-205, 5.5mm Wide**  
**Package Number BGA54A**  
**(Preliminary)**

**Physical Dimensions** inches (millimeters) unless otherwise noted (Continued)

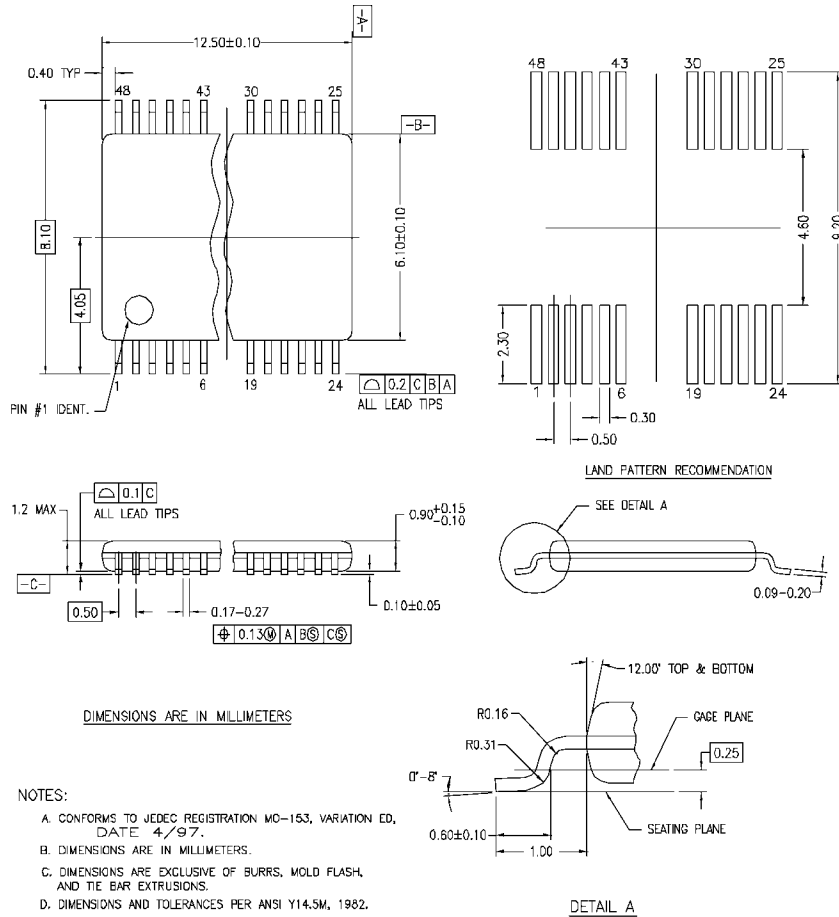

MTD48REV C

**48-Lead Thin Shrink Small Outline Package (TSSOP), JEDEC MO-153, 6.1mm Wide Package Number MTD48**

Fairchild does not assume any responsibility for use of any circuitry described, no circuit patent licenses are implied and Fairchild reserves the right at any time without notice to change said circuitry and specifications.

**LIFE SUPPORT POLICY**

FAIRCHILD'S PRODUCTS ARE NOT AUTHORIZED FOR USE AS CRITICAL COMPONENTS IN LIFE SUPPORT DEVICES OR SYSTEMS WITHOUT THE EXPRESS WRITTEN APPROVAL OF THE PRESIDENT OF FAIRCHILD SEMICONDUCTOR CORPORATION. As used herein:

1. Life support devices or systems are devices or systems which, (a) are intended for surgical implant into the body, or (b) support or sustain life, and (c) whose failure to perform when properly used in accordance with instructions for use provided in the labeling, can be reasonably expected to result in a significant injury to the user.
2. A critical component in any component of a life support device or system whose failure to perform can be reasonably expected to cause the failure of the life support device or system, or to affect its safety or effectiveness.

[www.fairchildsemi.com](http://www.fairchildsemi.com)