

1A Low Dropout Voltage Regulator

General Description

The AMS1117 series of adjustable and fixed voltage regulators are designed to provide up to 1A output current and to operate down to 1.2V input-to-output differential. The dropout voltage of the device is guaranteed maximum 1.3V, decreasing at lower load currents.

On-chip trimming adjusts the reference voltage to 1.5%. Current limit is set to minimize the stress under overload conditions on both the regulator and power source circuitry.

The AMS1117 devices are pin compatible with other three-terminal SCSII regulators and are offered in the low profile surface mount SOT-223 package, in the 8L SOIC package and in the TO-252 (DPAK) plastic package.

Features

- Three terminal Adjustable or Fixed Voltages: 1.25, 1.5V, 2.5V, 2.85V, 3.3V and 5.0V
- 1A maximum output current
- 1.2V of typical dropout voltage
- 0.2% maximum load regulation
- 0.4% maximum line regulation
- -40 to +125°C temperature range
- Available in SOT223, TO-252 and SO-8 package
- RoHS & WEEE compliant

Applications

- High Efficiency Linear Regulators
- Post Regulators for Switching Supplies
- 5V to 3.3V Linear Regulator
- Adjustable Power Supply
- Notebook/Personal Computer Supplies
- Active SCSII Terminator
- Battery Powered Instrumentation

Typical Application

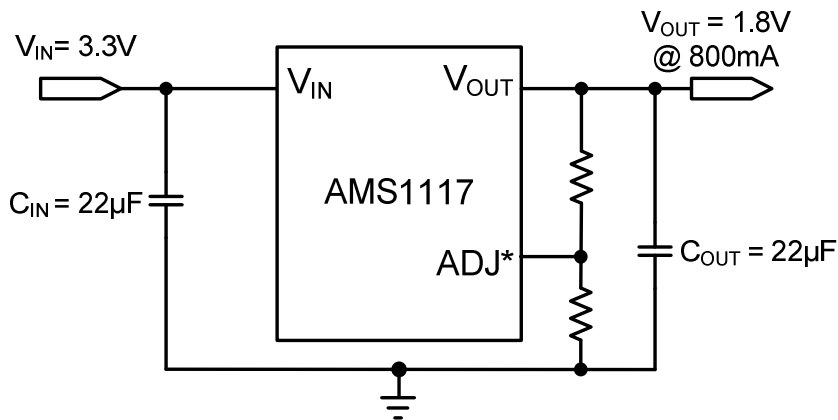

*For Fixed-Voltage Option, the ADJ pin becomes the GND pin

1A Low Dropout Voltage Regulator

Pin Description (SOT223 and TO- 252 Package)

Pin #	Symbol	Description
1	ADJ / GND	Adjust Voltage: This pin is the inverting input of the error amplifier. This allows the user to setup the output voltage by using two resistors. For fixed versions of AMS1117, this pin is connected to GND.
2	V_{OUT}	Output: This is the power output of the device.
3	V_{IN}	Input Supply Voltage: The pin powers the internal control circuitry and the internal power switch. Bypass V_{IN} with at ceramic capacitor from this pin to ground.

Pin Configuration

SOT252-3L (Top View)

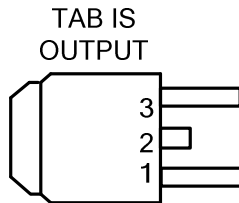

SOT223-3L (Top View)

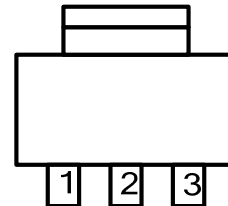

Pin Description (8L SOIC Package)

Pin #	Symbol	Description
1	ADJ / GND	Adjust Voltage: This pin is the inverting input of the error amplifier. This allows the user to setup the output voltage by using two resistors. For fixed versions of AMS1117, this pin is connected to GND.
2, 3, 6,7	V_{OUT}	Output: This is the power output of the device.
4	V_{IN}	Input Supply Voltage: The pin powers the internal control circuitry and the internal power switch. Bypass V_{IN} with at ceramic capacitor from this pin to ground.
5	N/C	Not connect
8	N/C	Not connect

Pin Configuration

8L SOIC (Top View)

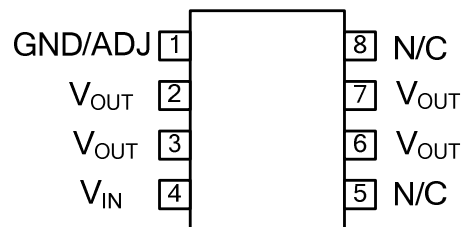

1A Low Dropout Voltage Regulator

Absolute Maximum Ratings⁽¹⁾

Maximum Input Supply Voltage (V_{IN}).....	-0.3V to 12V
Adjustable Voltage (ADJ).....	-0.3V to 12V
Storage Temperature Range.....	-65°C to 150°C
Lead Temperature.....	260°C
Junction Temperature.....	125°C

Recommended Operating Conditions

Input Voltage.....	3.3V to 12V
Ambient Operating Temperature.....	-40°C to 125°C

Thermal Information⁽²⁾

SOT223 θ_{ja}	95°C/W*
SOT252 θ_{ja}	80°C/W*
SO-8 θ_{ja}	80°C/W

* With paddle soldered to a PCB copper θ_{JA} can vary from 46°C/W to > 90°C/W depending copper area. See thermal graphs below and table 1.

Electrical Characteristics

Unless otherwise noted: $V_{IN} = V_{OUT} + 1.5V$, $I_{LOAD} = 0mA$, $C_{IN} = C_{OUT} = 22\mu F$, Typical values are $T_A = 25^\circ C$

Parameter	Symbol	Conditions	Min.	Typ.	Max.	Units
Reference Voltage	V_{ADJ}	$V_{IN} = V_{OUT} + 1.5V$, $I_{LOAD} = 10mA$	1.232	1.250	1.268	V
		$V_{IN} = V_{OUT} + 1.5V$, $I_{LOAD} = 10mA$ to 800mA	1.225	1.250	1.275	V
Output Voltage ⁽³⁾		$V_{IN} = 3V$, $V_{OUT} = 1.25V$	1.231	1.25	1.269	V
		$V_{IN} = 3V$, $V_{OUT} = 1.5V$	1.478 1.470	1.500	1.522 1.530	V V
		$V_{IN} = 3.3V$, $V_{OUT} = 1.8V$	1.773 1.764	1.800	1.827 1.836	V V
		$V_{IN} = 4V$, $V_{OUT} = 2.5V$	2.463 2.450	2.500	2.537 2.550	V V
		$V_{IN} = 4.35V$, $V_{OUT} = 2.85V$	2.808 2.793	2.850	2.892 2.907	V V
		$V_{IN} = 4.75V$, $V_{OUT} = 3.3V$	3.251 3.234	3.300	3.349 3.364	V V
		$V_{IN} = 6.5V$, $V_{OUT} = 5.0V$	4.925 4.900	5.000	5.075 5.100	V V
Minimum Load Current	I_{VIN}	Adjustable Version		8	10	mA
Ground Pin Current	I_{GND}	$V_{IN} = V_{OUT} + 2.5V$, Fixed Voltage Only		8	12	mA
Adjust Pin bias current	I_{ADJ_Bias}	Adjustable Version		40	120	μA
Output Current Limit	I_{OUT_CLIM}		900		1,500	mA
Load Regulation		$I_{OUT} = 0$ to 800mA, $V_{IN} - V_{OUT} = 1.5V$		0.25		%
Line Regulation		$V_{IN} = V_{OUT} + 1.5V$ to 12V, $I_{OUT} = 10mA$		0.35		%
Dropout Voltage	V_{DO}	$I_{OUT} = 100mA$		1.25	V	
		$I_{OUT} = 500mA$		1.35		
		($I_{OUT} = 800mA$)		1.45		
PSRR	dV_o/dV_i	$F = 120Hz$, $I_{OUT} = 100mA$, $V_{RIPPLE} = 0.5V_{P-P}$, $C_{OUT} = 22\mu F$		63		db
Output Noise Voltage	e_n	BW: 100Hz to 100 KHz $C_{OUT} = 22\mu F$, $I_{LOAD} = 250mA$		150		$\mu V(rms)$
Thermal Shutdown	T_{SD}			145		$^\circ C$
Thermal Shutdown Hysteresis	T_{SD_HYS}			15		$^\circ C$
Thermal Resistance	θ_{JC}	With package tab in free air		15		$^\circ C/W$

Electrical Characteristics Notes

Notes:

1. Stresses above those listed in Absolute Maximum Ratings may cause permanent damage to the device.
2. The total power dissipation for SOT223 and SOT252, packages varies with respect to the PCB layout, and ambient temperature. See the thermal characteristics graphs and table 1 below. Total power dissipation for the LDO should be taken in consideration when calculating the output current capability of each regulator at a given ambient temperature.
3. Line and Load regulation are guaranteed up to the maximum power dissipation of the package. Power dissipation is determined by the input/output differential and the output current and ambient temperature. Guaranteed maximum power dissipation will not be available over the full input/output range.

Typical Performance Characteristics

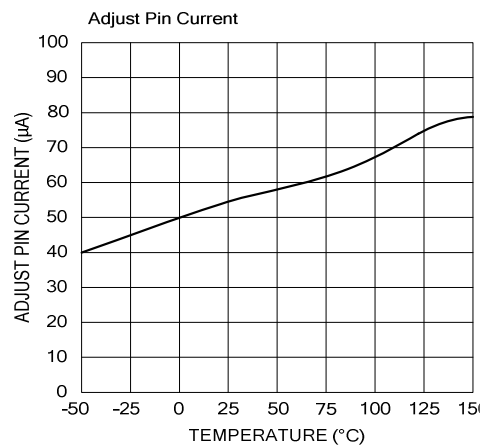
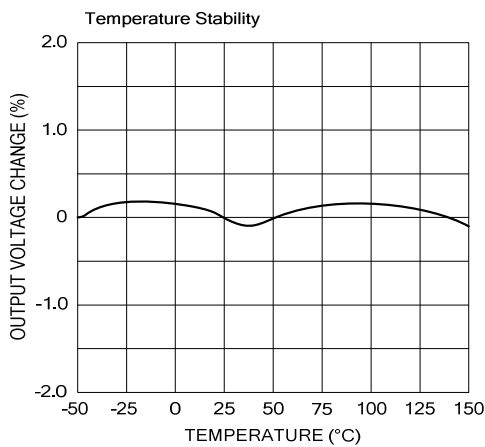
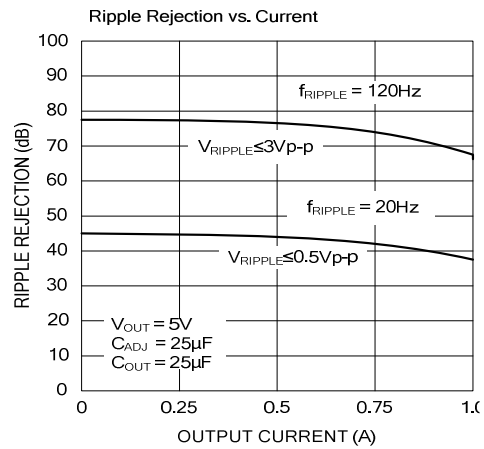
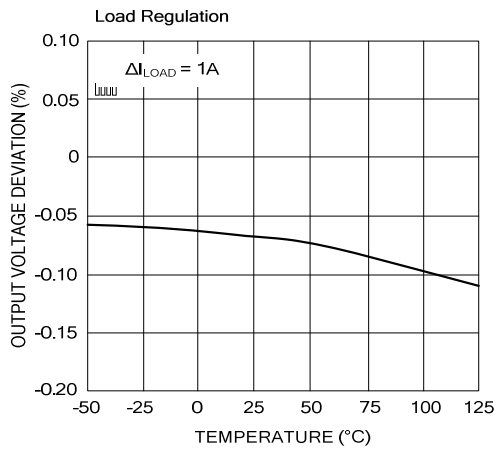
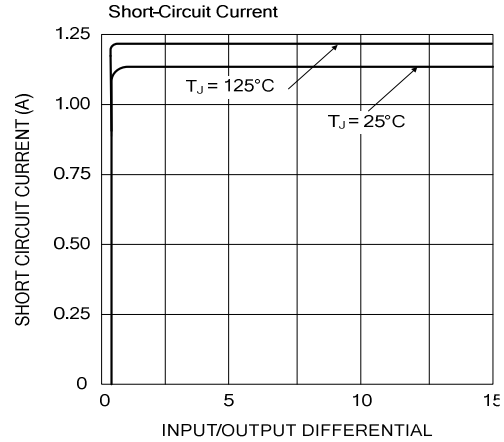
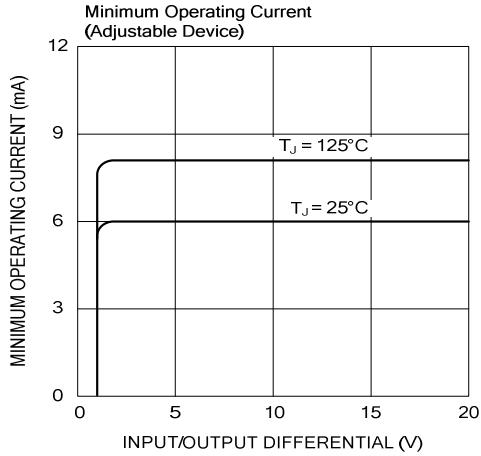

1A Low Dropout Voltage Regulator

Applications

The AMS1117 series of adjustable and fixed regulators are easy to use and are protected against short circuit and thermal overloads. Thermal protection circuitry will shut-down the regulator should the junction temperature exceed 165°C at the sense point.

Pin compatible with older three terminal adjustable regulators, these devices offer the advantage of a lower dropout voltage, more precise reference tolerance and improved reference stability with temperature.

Stability

The circuit design used in the AMS1117 series requires the use of an output capacitor as part of the device frequency compensation. The addition of 22µF solid tantalum on the output will ensure stability for all operating conditions.

When the adjustment terminal is bypassed with a capacitor to improve the ripple rejection, the requirement for an output capacitor increases. The value of 22µF tantalum covers all cases of bypassing the adjustment terminal. Without bypassing the adjustment terminal smaller capacitors can be used with equally good results.

To further improve stability and transient response of these devices larger values of output capacitor can be used.

Protection Diodes

Unlike older regulators, the AMS1117 family does not need any protection diodes between the adjustment pin and the output and from the output to the input to prevent over-stressing the die. Internal resistors are limiting the internal current paths on the AMS1117 adjustment pin, therefore even with capacitors on the adjustment pin no protection diode is needed to ensure device safety under short-circuit conditions.

Diodes between the input and output are not usually needed. Microsecond surge currents of 50A to 100A can be handled by the internal diode between the input and output pins of the device. In normal operations it is difficult to get those values of surge currents even with the use of large output capacitances. If high value output capacitors are used, such as 1000µF to 5000µF and the input pin is instantaneously shorted to ground, damage can occur. A diode from output to input is recommended, when a crowbar circuit at the input of the AMS1117 is used (Figure 1).

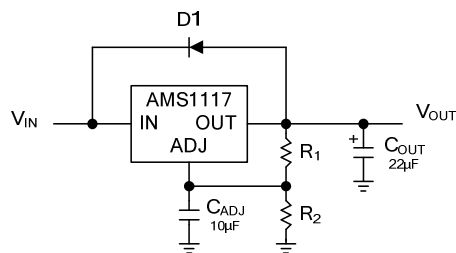
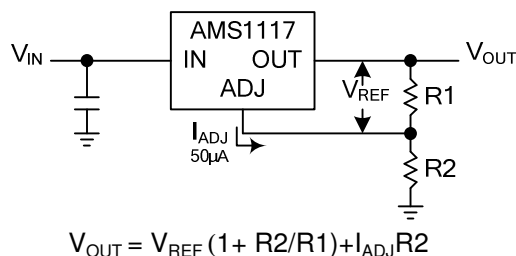

Figure 1.

Output Voltage

The AMS1117 series develops a 1.25V reference voltage between the output and the adjust terminal. Placing a resistor between these two terminals causes a constant current to flow through R1 and down through R2 to set the overall output voltage. This current is normally the specified minimum load current of 10mA. Because I_{ADJ} is very small and constant it represents a small error and it can usually be ignored.



$$V_{OUT} = V_{REF} (1 + R2/R1) + I_{ADJ} R2$$

Figure 2. Basic Adjustable Regulator

Load Regulation

For optimum load regulation R1 and R2 should be tied as close to the point of load as possible. This compensates for any output voltage drop related to load current conduction through PCB traces.

1A Low Dropout Voltage Regulator

Applications continued

Connected as shown, R_P is not multiplied by the divider ratio

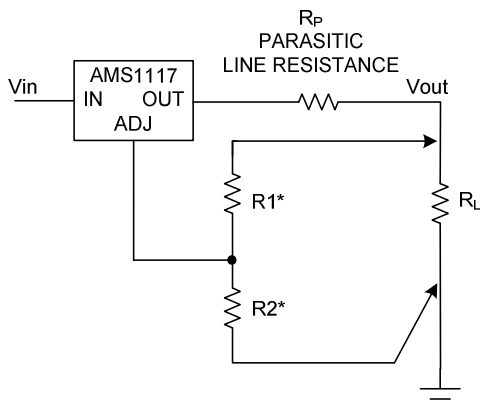

*connect R1 and R2 to load

Figure 3. Connections for Best Load Regulation

In the case of fixed voltage devices the top of R1 is connected internally, and the ground pin can be used for negative side sensing.

Thermal Considerations

The AMS1117 series have internal power and thermal limiting circuitry designed to protect the device under overload conditions. However maximum junction temperature ratings of 125°C should not be exceeded under continuous normal load conditions.

Careful consideration must be given to all sources of thermal resistance from junction to ambient. For the surface mount package SOT-223 additional heat sources mounted near the device must be considered. The heat dissipation capability of the PC board and its copper traces is used as a heat sink for the device. The thermal resistance from the junction to the tab for the AMS1117 is 15°C/W. Thermal resistance from tab to ambient can be as low as 30°C/W.

The PC material can be very effective at transmitting heat between the pad area, attached to the pad of the device, and a ground plane layer either inside or on the opposite side of the board. Although the actual thermal resistance of the PC material is high, the Length/Area ratio of the thermal resistance between layers is small. The data in Table 1, was taken using 1/16" FR-4 board with 1 oz. copper foil, and it can be used as a rough guideline for estimating thermal resistance.

For each application the thermal resistance will be affected by thermal interactions with other components on the board. To determine the actual value some experimentation will be necessary.

The efficiency for all linear regulators (excluding the ground current) is equal to V_{out}/V_{in} . For an output voltage that is one half of the input voltage the efficiency is about 50%. The maximum load current capability for **any** LDO is strictly a function of the package, the PCB interface and layout, and the input to output voltage drop across the device.

The graphs below display the typical output current capabilities for a wide range of ambient temperatures, input-output voltage differentials, and the typical range of thermal impedances for the SOT223 and TO252 packages. The maximum output current is thermally limited by the maximum power (P_{dmax}) and the input to output voltage differential ($V_{in}-V_{out}$).

$$I_{o\max} = \frac{P_{d\max}}{V_{in}-V_{out}}$$

The equation used in the graphs to determine the thermal limit in output current is;

$$I_{o\max} = \frac{T_j - T_a}{\theta_{ja} \cdot (V_{in} - V_{out})}$$

- **$I_{o\max}$** is the maximum output current as limited by the power dissipation and temperature rise of the device.
- **T_j** is the maximum junction temperature assumed here to be 125°C
- **T_a** ambient temperature
- **θ_{ja}** is the thermal impedance from the junction of the device to the ambient air in °C/W.
- **V_{in}** is the DC input Voltage
- **V_{out}** is the DC output Voltage

It must be stressed that other nearby heat generating devices will offset the PCB and junction temperature, further reducing the maximum current capability of the device. Increased output current capability can be achieved with forced air flow across the PCB and device.

Ripple Rejection

The ripple rejection values are measured with the adjustment pin bypassed. The impedance of the adjust pin capacitor at the ripple frequency should be less than the value of R1 (normally 100Ω to 200Ω) for a proper bypassing and ripple rejection approaching the values shown. The size of the required adjust pin capacitor is a function of the input ripple frequency. If $R1=100\Omega$ at 120Hz the adjust pin capacitor should be $>13\mu F$. At 10kHz only 0.16μF is needed.

The ripple rejection will be a function of output voltage, in circuits without an adjust pin bypass capacitor. The output ripple will increase directly as a ratio of the output voltage to the reference voltage (V_{OUT} / V_{REF}).

SOT223 Thermal Characteristics

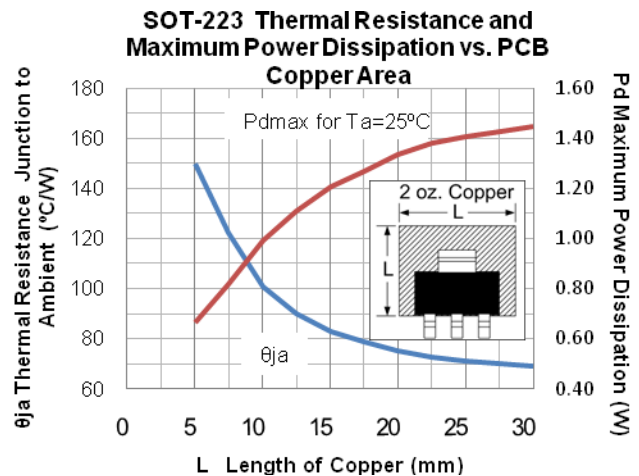
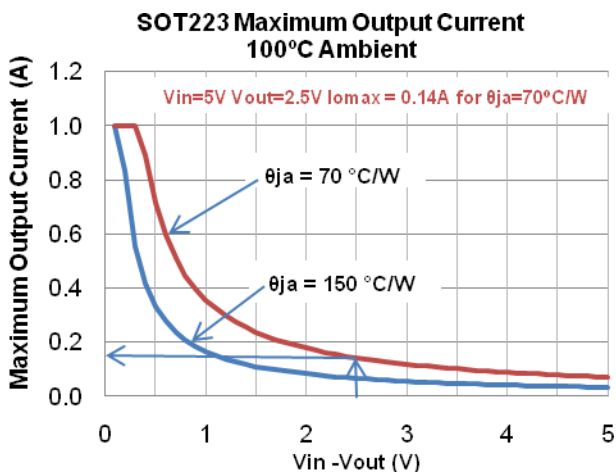
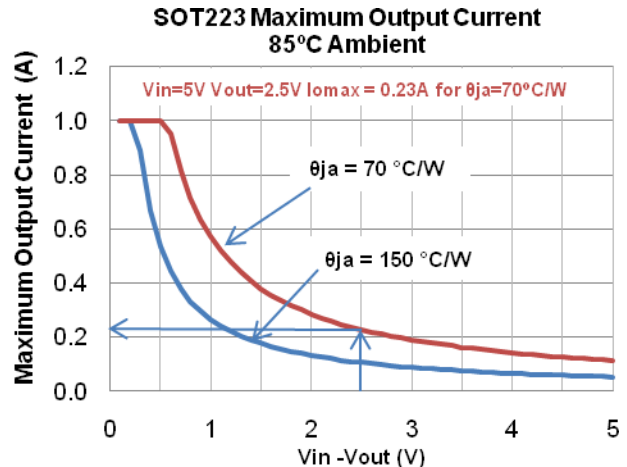
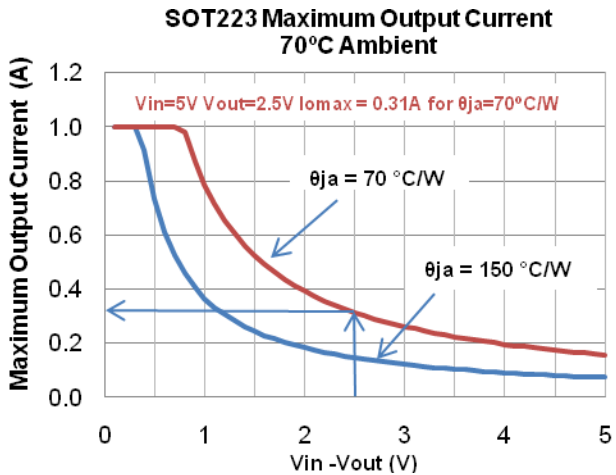
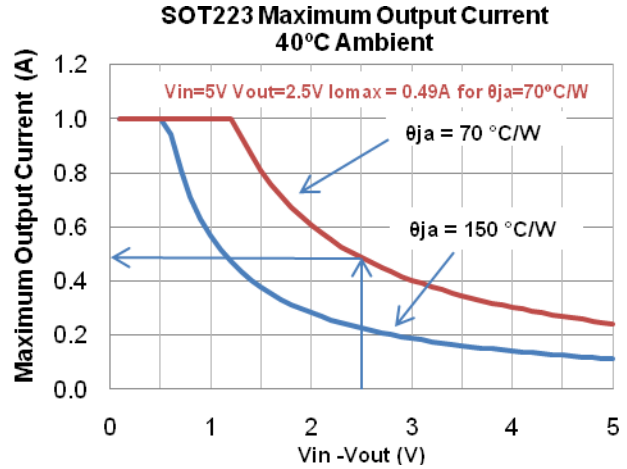
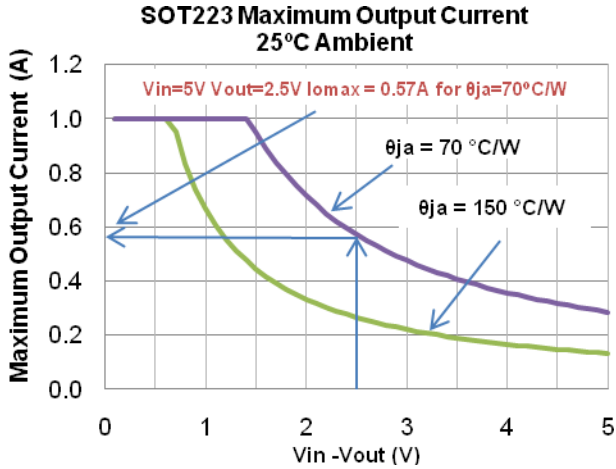

1A Low Dropout Voltage Regulator

TO252 Thermal Characteristics

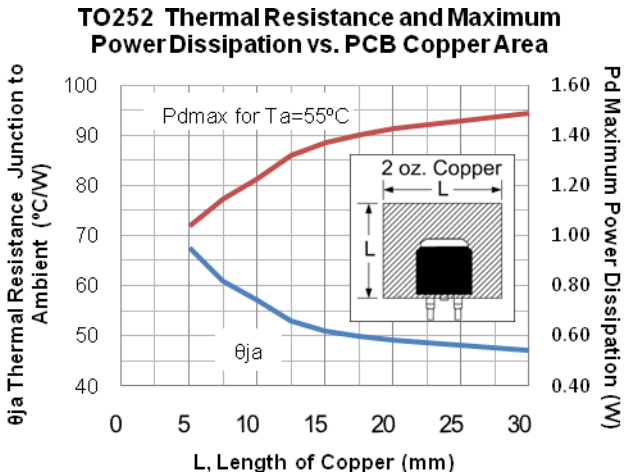
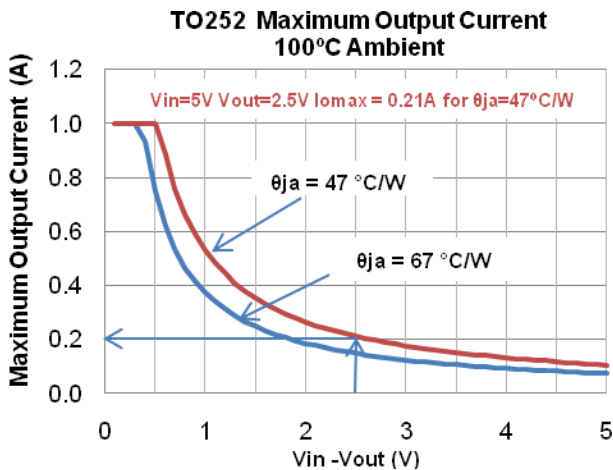
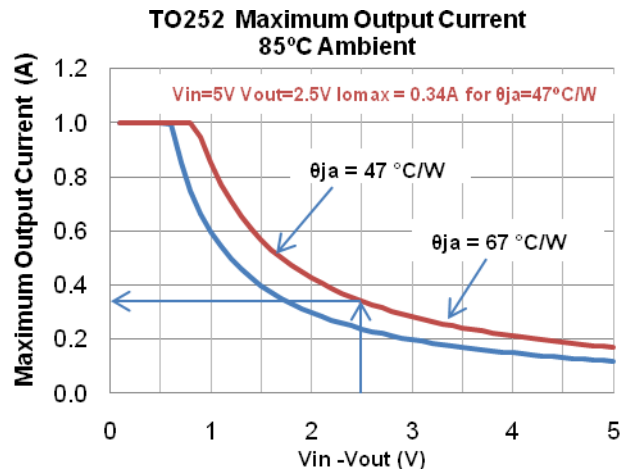
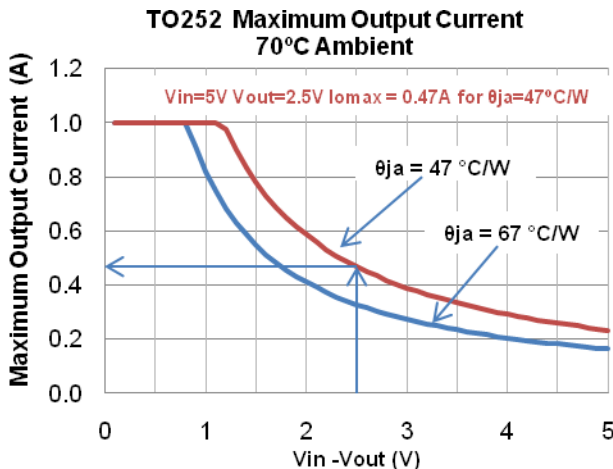
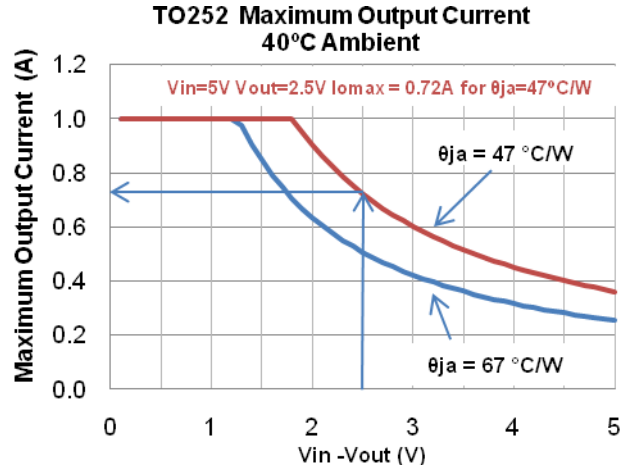
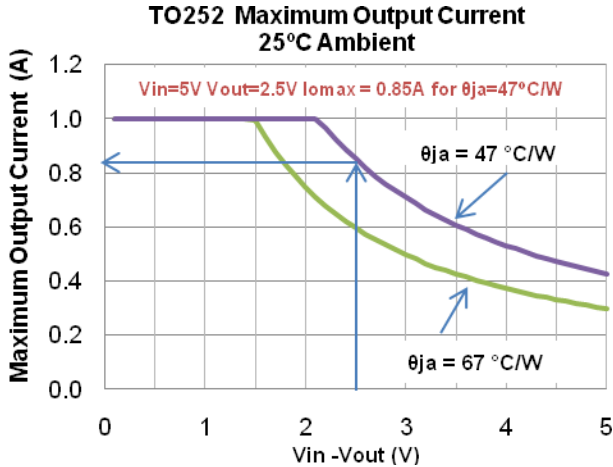

Table 1.

COPPER AREA		BOARD AREA	Thermal Resistance (Junction-To-Ambient)
TOP SIDE*	BACK SIDE		
2500 Sq. mm	2500 Sq. mm	2500 Sq. mm	55°C/W
1000 Sq. mm	2500 Sq. mm	2500 Sq. mm	55°C/W
225 Sq. mm	2500 Sq. mm	2500 Sq. mm	65°C/W
100 Sq. mm	2500 Sq. mm	2500 Sq. mm	80°C/W
1000 Sq. mm	1000 Sq. mm	1000 Sq. mm	60°C/W
1000 Sq. mm	0	1000 Sq. mm	65°C/W

*Tab of device attached to topside copper.

Ordering Information

Device	Package
AMS1117 ⁽¹⁾⁽²⁾	3L SOT-223
AMS1117-X.X ⁽¹⁾⁽²⁾⁽³⁾	3L SOT-223

Notes:

1. Available in tape and reel only. A reel contains 2,500 devices.
2. Available in lead-free package only. Device is fully WEEE and RoHS compliant
3. Need to specify output voltage option (1.5V, 1.8V, 2.5V, 2.85V, 3.3V, 5V)

Package Outline Drawing

Package dimensions are inches (millimeters) unless otherwise noted.

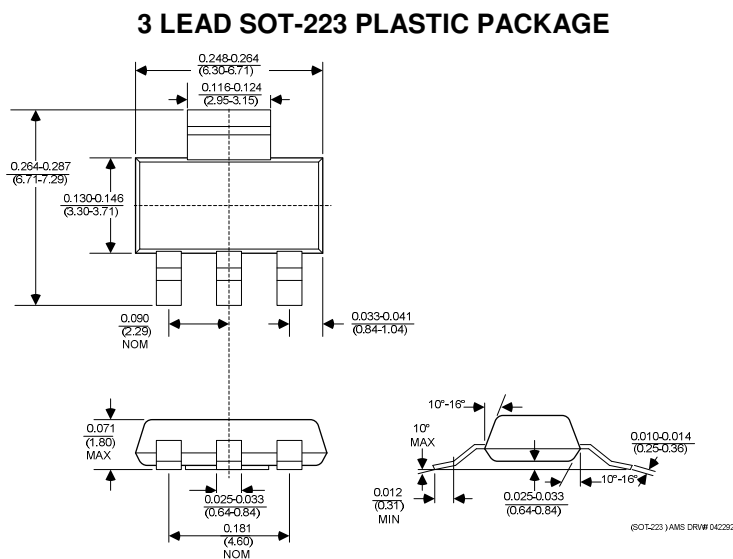

Ordering Information

Device	Package
AMS1117CD ⁽¹⁾⁽²⁾	TO-252 (DPAK)
AMS1117CD-X.X ⁽¹⁾⁽²⁾⁽³⁾	TO-252 (DPAK)

Notes:

1. Available in tape and reel only. A reel contains 2,500 devices.
2. Available in lead-free package only. Device is fully WEEE and RoHS compliant
3. Need to specify output voltage option (1.25, 1.5V, 1.8V, 2.5V, 2.85V, 3.3V, 5V)

Package Outline Drawing

Package dimensions are inches (millimeters) unless otherwise noted.

TO-252 PLASTIC PACKAGE (D)

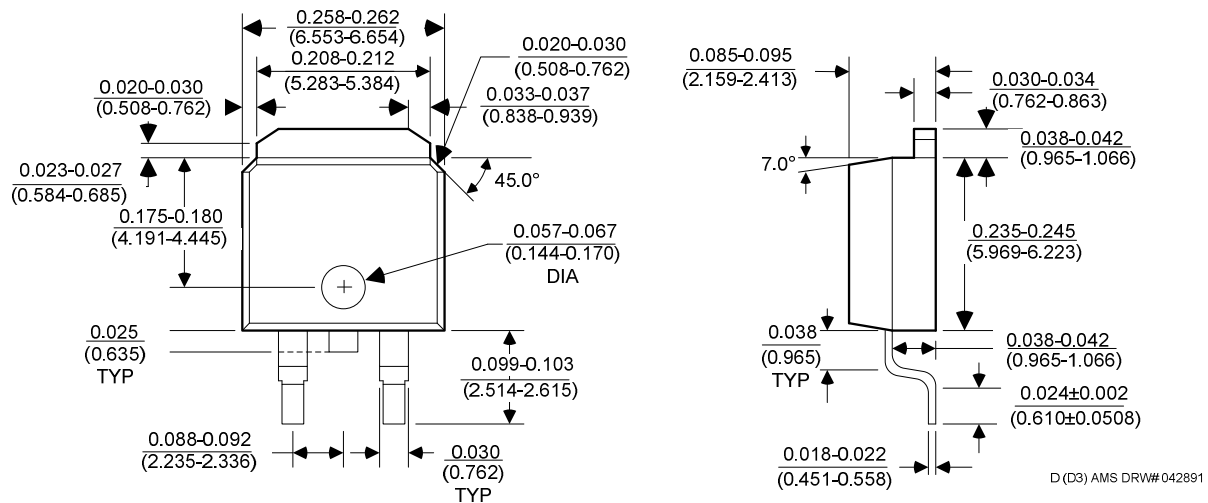

Ordering Information

Device	Package
AMS1117CS ⁽¹⁾⁽²⁾	8L SOIC
AMS1117CS-X.X ⁽¹⁾⁽²⁾⁽³⁾	8L SOIC

Notes:

1. Available in tape and reel only. A reel contains 2,500 devices.
2. Available in lead-free package only. Device is fully WEEE and RoHS compliant
3. Need to specify output voltage option (1.5V, 1.8V, 2.5V, 2.85V, 3.3V, 5V)

Package Outline Drawing

Package dimensions are inches (millimeters) unless otherwise noted.

8 LEAD SOIC PLASTIC PACKAGE (S)

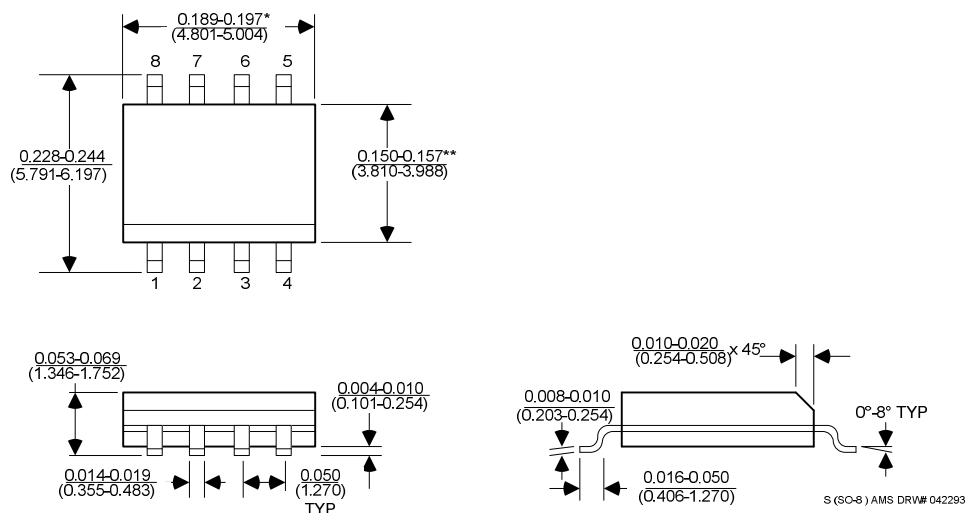

*DIMENSION DOES NOT INCLUDE MOLD FLASH. MOLD FLASH SHALL NOT EXCEED 0.006" (0.152mm) PER SIDE

**DIMENSION DOES NOT INCLUDE INTERLEAD FLASH. INTERLEAD FLASH SHALL NOT EXCEED 0.010" (0.254mm) PER SIDE