

National Semiconductor is now part of
Texas Instruments.

Search <http://www.ti.com/> for the latest technical
information and details on our current products and services.

LM4935 Boomer® Audio Power Amplifier Series

Audio Sub-System with Dual-Mode Stereo Headphone & Mono High Efficiency Loudspeaker Amplifiers and Multi-Purpose ADC

1.0 General Description

The LM4935 is an integrated audio subsystem that supports both analog and digital audio functions. The LM4935 includes a high quality stereo DAC, a mono ADC, a multi-purpose SAR ADC, a stereo headphone amplifier, which supports output cap-less (OCL) or AC-coupled (SE) modes of operation, a mono earpiece amplifier and a mono high efficiency loudspeaker amplifier. It is designed for demanding applications in mobile phones and other portable devices.

The LM4935 features a bi-directional I²S serial interface for full range audio and an I²C or SPI compatible interface for control. The stereo DAC path features an SNR of 88 dB with an 18-bit 48 kHz input. In SE mode the headphone amplifier delivers at least 33 mW_{RMS} to a 32Ω single-ended stereo load with less than 1% distortion (THD+N) when A_{VDD} = 3.3V. The mono earpiece amplifier delivers at least 115 mW_{RMS} to a 32Ω bridged-tied load with less than 1% distortion (THD+N) when A_{VDD} = 3.3V. The mono speaker amplifier delivers up to 600 mW into an 8Ω load with less than 1% distortion when LS_{VDD} = 3.3V and up to 1.3W when LS_{VDD} = 5.0V. The LM4935 also contains a general purpose SAR ADC for housekeeping duties such as battery and temperature monitoring. This can also be used for analog volume control of the output stages and can trigger interrupt events.

The LM4935 employs advanced techniques to reduce power consumption, to reduce controller overhead to speed development time and to eliminate click and pop. Boomer audio power amplifiers were designed specifically to provide high quality output power with a minimal amount of external components. It is therefore ideally suited for mobile phone and other low voltage applications where minimal power consumption, PCB area and cost are primary requirements.

2.0 Applications

- Smartphones
- Mobile Phones and Multimedia Terminals
- PDAs, Internet Appliances and Portable Gaming
- Portable DVD/CD/AAC/MP3 Players
- Digital Cameras/Camcorders

3.0 Key Specifications

■ P _{HP (AC-COUP)} @ A _{VDD} = 3.3V, 32Ω, 1% THD	33 mW
■ P _{HP (OCL)} @ A _{VDD} = 3.3V, 32Ω, 1% THD	31 mW
■ P _{LS} @ LS _{VDD} = 5V, 8Ω, 1% THD	1.3 W
■ P _{LS} @ LS _{VDD} = 4.2V, 8Ω, 1% THD	900 mW
■ P _{LS} @ LS _{VDD} = 3.3V, 8Ω, 1% THD	600 mW

- Supply Voltage Range
 - BB_{VDD} = 1.8V to 4.5V,
 - D_{VDD} & PLL_{VDD} = 2.7V to 4.5V
 - LS_{VDD} & A_{VDD} = 2.7V to 5.5V
- Shutdown Current 1.1 μA
- PSRR @ 217 Hz, A_{VDD} = 3.3V, (Headphone) 60 dB
- SNR (Stereo DAC to AUXOUT) 88 dB (typ)
- SNR (Mono ADC from Cell Phone In) 90 dB (typ)
- SNR (Aux In to Headphones) 98 dB (typ)

4.0 Features

- 18-bit stereo DAC
- 16-bit mono ADC
- 12-bit 4 input multipurpose SAR ADC
- 8 kHz to 48 kHz stereo audio playback
- 8 kHz to 48 kHz mono recording
- 1 Hz to 13.888 kHz sample rate on all 4 SAR channels
- Bidirectional PCM/I²S compatible audio interface
- Sigma-Delta PLL for operation from any clock at any sample rate
- Low power clock network operation if 12 MHz system clock is available
- Read/write I²C or SPI compatible control interface
- 33mW stereo headphone amplifier at 3.3V
- OCL or AC-coupled headphone operation
- Automatic headphone & microphone detection
- Support for internal and external microphones
- Automatic gain control for microphone input
- High efficiency BTL 8Ω amplifier, 600 mW @ 3.3V
- 115 mW earpiece amplifier at 3.3V
- Differential audio I/O for external cellphone module
- Mono differential auxiliary output
- Stereo auxiliary inputs
- Differential microphone input for internal microphone
- Flexible audio routing from input to output
- 32 Step volume control for mixers with 1.5 dB steps
- 16 Step volume control for microphone in 2 dB steps
- Programmable sidetone attenuation in 3 dB steps
- DC Volume Control
- Two configurable GPIO ports
- Programmable voltage triggers on SAR channels
- Multi-function IRQ output
- Micro-power shutdown mode
- Available in the 4 x 4 mm 49 bump micro SMDxt package

6.0 Typical Application

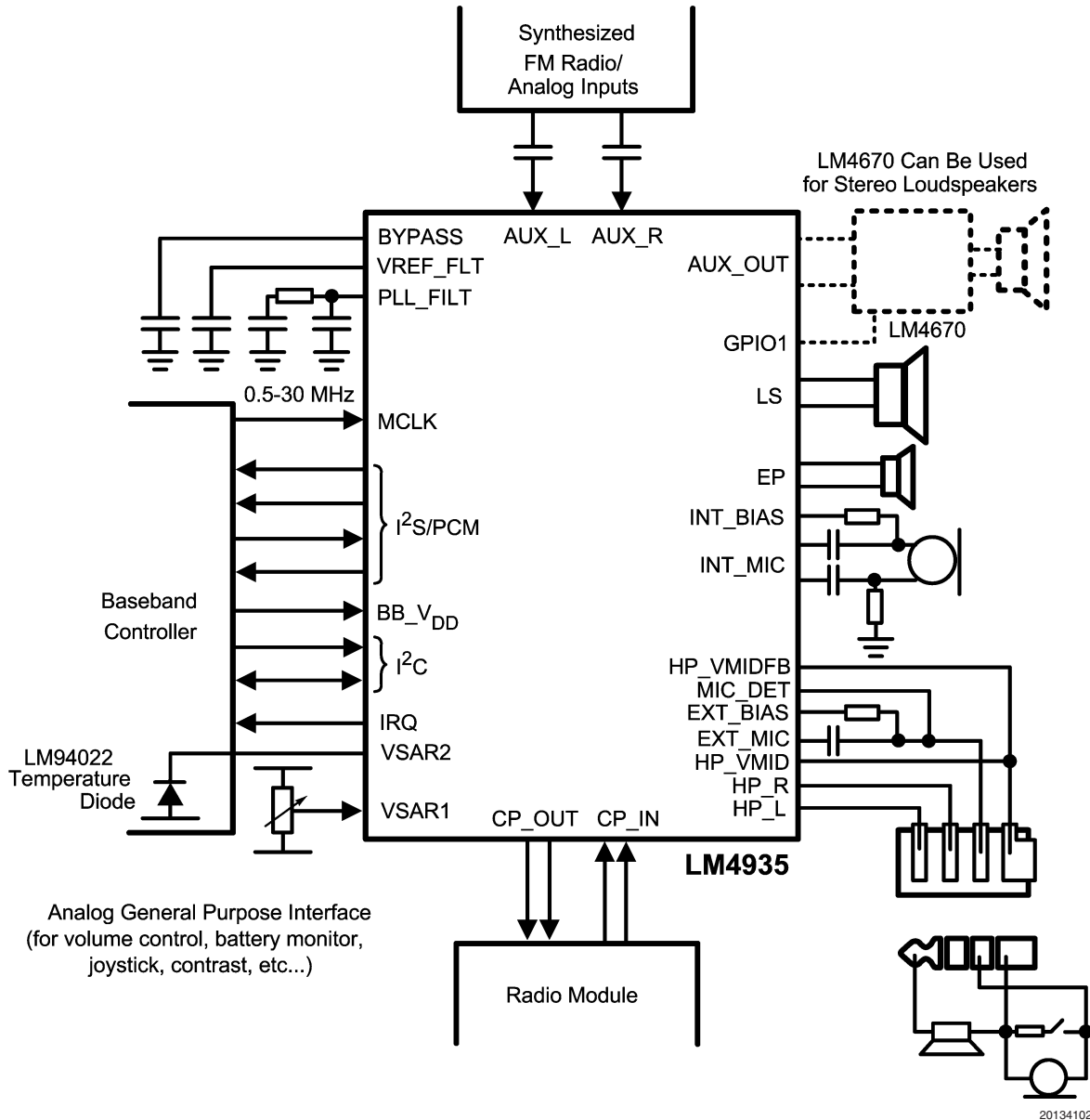

FIGURE 2. Example Application in Multimedia Mobile Phone

Table of Contents

1.0 General Description	1
2.0 Applications	1
3.0 Key Specifications	1
4.0 Features	1
5.0 LM4935 Overview	2
6.0 Typical Application	3
7.0 Connection Diagrams	6
7.1 PIN TYPE DEFINITIONS	8
8.0 Absolute Maximum Ratings	9
9.0 Operating Ratings	9
10.0 Electrical Characteristics	9
11.0 System Control	17
11.1 I ² C SIGNALS	17
11.2 I ² C DATA VALIDITY	17
11.3 I ² C START AND STOP CONDITIONS	17
11.4 TRANSFERRING DATA	17
11.5 I ² C TIMING PARAMETERS	19
12.0 Status & Control Registers	21
12.1 BASIC CONFIGURATION REGISTER	22
12.2 CLOCKS CONFIGURATION REGISTER	23
12.3 LM4935 CLOCK NETWORK	24
12.4 COMMON CLOCK SETTINGS FOR THE DAC & ADC	25
12.5 PLL M DIVIDER CONFIGURATION REGISTER	26
12.6 PLL N DIVIDER CONFIGURATION REGISTER	27
12.7 PLL P DIVIDER CONFIGURATION REGISTER	28
12.8 PLL N MODULUS CONFIGURATION REGISTER	29
12.9 FURTHER NOTES ON PLL PROGRAMMING	30
12.10 ADC_1 CONFIGURATION REGISTER	32
12.11 ADC_2 CONFIGURATION REGISTER	33
12.12 AGC_1 CONFIGURATION REGISTER	34
12.13 AGC_2 CONFIGURATION REGISTER	35
12.14 AGC_3 CONFIGURATION REGISTER	36
12.15 AGC OVERVIEW	37
12.16 MIC_1 CONFIGURATION REGISTER	38
12.17 MIC_2 CONFIGURATION REGISTER	39
12.18 SIDETONE ATTENUATION REGISTER	40
12.19 CP_INPUT CONFIGURATION REGISTER	41
12.20 AUX_LEFT CONFIGURATION REGISTER	42
12.21 AUX_RIGHT CONFIGURATION REGISTER	43
12.22 DAC CONFIGURATION REGISTER	44
12.23 CP_OUTPUT CONFIGURATION REGISTER	45
12.24 AUX_OUTPUT CONFIGURATION REGISTER	46
12.25 LS_OUTPUT CONFIGURATION REGISTER	47
12.26 HP_OUTPUT CONFIGURATION REGISTER	48
12.27 EP_OUTPUT CONFIGURATION REGISTER	49
12.28 DETECT CONFIGURATION REGISTER	50
12.29 HEADSET DETECT OVERVIEW	51
12.30 STATUS REGISTER	54
12.31 AUDIO INTERFACE CONFIGURATION REGISTER	55
12.32 DIGITAL AUDIO DATA FORMATS	56
12.33 GPIO CONFIGURATION REGISTER	57
12.34 SAR CHANNELS 0 & 1 CONFIGURATION REGISTER	58
12.35 SAR CHANNELS 2 & 3 CONFIGURATION REGISTER	59
12.36 SAR DATA 0 TO 3 REGISTERS	60
12.37 SAR OVERVIEW	61
12.38 DC VOLUME CONFIGURATION REGISTER	63
12.39 SAR TRIGGER 1 CONFIGURATION REGISTER	64
12.40 SAR TRIGGER 1 MSBs CONFIGURATION REGISTER	65
12.41 SAR TRIGGER 2 CONFIGURATION REGISTER	66
12.42 SAR TRIGGER 2 MSBs CONFIGURATION REGISTER	67
12.43 DEBUG REGISTER	68
13.0 Typical Performance Characteristics	69

Table of Contents (Continued)

14.0 LM4935 Demonstration Board Schematic Diagram	105
15.0 Demoboard PCB Layout	106
16.0 Product Status Definitions	111
17.0 Revision History	112
18.0 Physical Dimensions	113

7.0 Connection Diagrams

49 Bump micro SMDxt

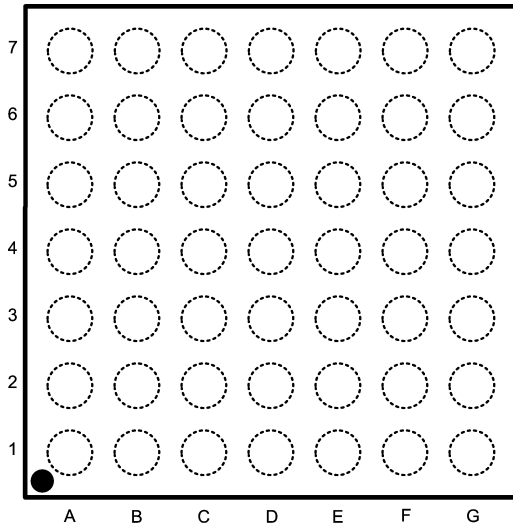

Top View (Bump Side Down)
Order Number LM4935RL
See NS Package Number RLA49UUA

49 Bump micro SMDxt Marking

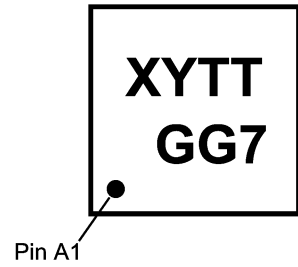

Top View
XY — Date Code
TT — Die Traceability
G — Boomer
G7 — LM4935RL

7.0 Connection Diagrams (Continued)

Pin Descriptions

Pin	Pin Name	Type	Direction	Description
A1	EP_NEG	Analog	Output	Earpiece negative output
A2	A_V _{DD}	Supply	Input	Headphone and mixer V _{DD}
A3	INT_MIC_POS	Analog	Input	Internal microphone positive input
A4	EXT_MIC	Analog	Input	External microphone input
A5	VSAR2	Analog	Input	Input to SAR channel 2
A6	VSAR1	Analog	Input	Input to SAR channel 1
A7	PLL_V _{SS}	Supply	Input	PLL V _{SS}
B1	A_V _{SS}	Supply	Input	Headphone and mixer V _{SS}
B2	EP_POS	Analog	Output	Earpiece positive output
B3	INT_MIC_NEG	Analog	Input	Internal microphone negative input
B4	BYPASS	Analog	Inout	A_V _{DD} /2 filter point
B5	TEST_MODE/ $\overline{\text{CS}}$	Digital	Input	If SPI_MODE = 1, then this pin becomes $\overline{\text{CS}}$. If SPI_MODE = 0, and TEST_MODE/ $\overline{\text{CS}}$ = 1, then this places the LM4935 into test mode.
B6	PLL_FILT	Analog	Inout	Filter point for PLL VCO input
B7	PLL_V _{DD}	Supply	Input	PLL V _{DD}
C1	HP_R	Analog	Output	Headphone Right Output
C2	EXT_BIAS	Analog	Output	External microphone supply (2.0/2.5/2.8/3.3V)
C3	INT_BIAS	Analog	Output	2.0V/2.5V ultra-clean supply for internal microphone
C4	AUX_R	Analog	Input	Right Analog Input
C5	GPIO_2	Digital	Inout	General Purpose I/O 2
C6	SDA	Digital	Inout	Control Data, I2C_SDA or SPI_SDI
C7	SCL	Digital	Input	Control Clock, I2C_SCL or SPI_SCK
D1	HP_L	Analog	Output	Headphone Left Output
D2	VREF_FLT	Analog	Inout	Filter point for the microphone power supply
D3	AUX_L	Analog	Input	Left Analog Input
D4	SPI_MODE	Digital	Input	Control mode select 1 = SPI, 0 = I2C (or test)
D5	GPIO_1	Digital	Inout	General Purpose I/O 1
D6	BB_V _{DD}	Supply	Input	Baseband V _{DD} for the digital I/Os
D7	D_V _{DD}	Supply	Input	Digital V _{DD}
E1	HP_VMID	Analog	Inout	Virtual Ground for Headphones in OCL mode, otherwise 1st headset detection input
E2	HP_VMID_FB	Analog	Inout	VMID Feedback in OCL mode, otherwise a 2nd headset detection input
E3	MIC_DET	Analog	Input	Headset insertion/removal and Microphone presence detection input
E4	CPI_NEG	Analog	Input	Cell Phone analog input negative
E5	IRQ	Digital	Output	Interrupt request signal (NOT open drain)
E6	I2S_SDO	Digital	Output	I2S Serial Data Out
E7	I2S_SDI	Digital	Input	I2S Serial Data Input
F1	LS_V _{DD}	Supply	Input	Loudspeaker V _{DD}
F2	LS_V _{DD}	Supply	Input	Loudspeaker V _{DD}
F3	CPI_POS	Analog	Input	Cell Phone analog input positive
F4	CPO_NEG	Analog	Output	Cell Phone analog output negative
F5	AUX_OUT_NEG	Analog	Output	Auxiliary analog output negative
F6	I2S_WS	Digital	Inout	I2S Word Select Signal (can be master or slave)
F7	I2S_CLK	Digital	Inout	I2S Clock Signal (can be master or slave)
G1	LS_POS	Analog	Output	Loudspeaker positive output
G2	LS_V _{SS}	Supply	Input	Loudspeaker V _{SS}
G3	LS_NEG	Analog	Output	Loudspeaker negative output
G4	CPO_POS	Analog	Output	Cell Phone analog output positive
G5	AUX_OUT_POS	Analog	Output	Auxiliary analog output positive

7.0 Connection Diagrams (Continued)

Pin Descriptions (Continued)

Pin	Pin Name	Type	Direction	Description
G6	D_V _{SS}	Supply	Input	Digital V _{SS}
G7	MCLK	Digital	Input	Input clock from 0.5 MHz to 30 MHz

7.1 PIN TYPE DEFINITIONS

Analog Input— A pin that is used by the analog and is never driven by the device. Supplies are part of this classification.

Analog Output— A pin that is driven by the device and should not be driven by external sources.

Analog Inout— A pin that is typically used for filtering a DC signal within the device. Passive components can be connected to these pins.

Digital Input— A pin that is used by the digital but is

never driven.

Digital Output— A pin that is driven by the device and should not be driven by another device to avoid contention.

Digital Inout— A pin that is either open drain (I2C_SDA) or a bidirectional CMOS in/out. In the later case the direction is selected by a control register within the LM4935.

8.0 Absolute Maximum Ratings

(Notes 1, 2)

If Military/Aerospace specified devices are required, please contact the National Semiconductor Sales Office/Distributors for availability and specifications.

Analog Supply Voltage (A_V _{DD} & LS_V _{DD})	6.0V
Digital Supply Voltage (BB_V _{DD} & D_V _{DD} & PLL_V _{DD})	6.0V
Storage Temperature	-65°C to +150°C
Power Dissipation (Note 3)	Internally Limited
ESD Susceptibility	
Human Body Model (Note 4)	2500V
Machine Model (Note 5)	200V

Junction Temperature	150°C
Thermal Resistance θ_{JA} – RLA49 (soldered down to PCB with 2in ² 1oz. copper plane)	60°C/W
Soldering Information	

9.0 Operating Ratings

Temperature Range	-40°C to +85°C
Supply Voltage	
D_V _{DD} /PLL_V _{DD}	2.7V to 4.5V
BB_V _{DD}	1.8V to 4.5V
LS_V _{DD} /A_V _{DD}	2.7V to 5.5V

10.0 Electrical Characteristics (Notes 1, 2) Unless otherwise stated **PLL_V_{DD} = 3.3V, D_V_{DD} = 3.3V, BB_V_{DD} = 1.8V, A_V_{DD} = 3.3V, LS_V_{DD} = 3.3V**. The following specifications apply for the circuit shown in *Figure 2* unless otherwise stated. Limits apply for 25°C.

Symbol	Parameter	Conditions	LM4935		Units
			Typical (Note 6)	Limit (Note 7)	
DC CURRENT CONSUMPTION					
DI _{SD}	Digital Shutdown Current	Chip Mode '00', f _{MCLK} = 13MHz	0.7		μA
		Chip Mode '00', f _{MCLK} = 19.2MHz	0.7	5	μA (max)
DI _{ST}	Digital Standby Current	Chip Mode '01', f _{MCLK} = 13MHz	1.5		mA
		Chip Mode '01', f _{MCLK} = 19.2MHz	2.2	3	mA (max)
DI _{DD}	Digital Active Current	Chip Mode '10', f _{MCLK} = 13MHz, DAC, ADC, SAR OFF	1.5		mA
		Chip Mode '10', f _{MCLK} = 19.2MHz, DAC, ADC, SAR OFF	2.2		mA
		Chip Mode '10', f _{MCLK} = 13MHz DAC, ADC, SAR ON	11.2		mA
		Chip Mode '10', f _{MCLK} = 19.2MHz, DAC, ADC, SAR ON	16.2	20	mA (max)
AI _{SD}	Analog Shutdown Current	Chip Mode '00'	0.2	3	μA (max)
AI _{ST}	Analog Standby Current	Chip Mode '01', No headset inserted	0.2	3	μA (max)
AI _{DD}	Analog Active Current	All Outputs OFF, SE MODE	6.1		mA
		All Outputs OFF, OCL MODE	5.7		mA
		All Outputs ON, SE MODE	18.3		mA
		All Outputs ON, OCL MODE	18.7	28	mA (max)
PLLI _{DD}	PLL Active Current	f _{MCLK} = 13 MHz f _{PLLOUT} = 12 MHz, PLL ON only	4.2		mA
		f _{MCLK} = 19.2 MHz f _{PLLOUT} = 12 MHz, PLL ON only	6.2		mA
ADCI _{DD}	ADC Active Current	f _{MCLK} = 13MHz, ADC ON only	2.5		mA
		f _{MCLK} = 19.2MHz, ADC ON only	3.6		mA

10.0 Electrical Characteristics (Notes 1, 2) Unless otherwise stated $PLL_V_{DD} = 3.3V$, $D_V_{DD} = 3.3V$, $BB_V_{DD} = 1.8V$, $A_V_{DD} = 3.3V$, $LS_V_{DD} = 3.3V$. The following specifications apply for the circuit shown in *Figure 2* unless otherwise stated. Limits apply for 25°C. (Continued)

Symbol	Parameter	Conditions	LM4935		Units
			Typical (Note 6)	Limit (Note 7)	
DC CURRENT CONSUMPTION					
DACI _{DD}	DAC Active Current	f _{MCLK} = 13MHz, DAC ON only; PLL OFF, f _S = 48kHz	7.4		mA
		f _{MCLK} = 19.2MHz, DAC ON only PLL OFF; f _S = 48kHz	10.7		mA
SARI _{DD}	SAR Active Current	f _{MCLK} = 13MHz, SAR ON only	1.6		mA
		f _{MCLK} = 19.2MHz, SAR ON only	2.3		mA
LSI _{DD}	Loudspeaker Quiescent Current	LS ON only	8.8		mA
HPI _{DD}	Headphone Quiescent Current	HP ON only, SE MODE	3.5		mA
		HP ON only, OCL MODE	3.9		mA
EPI _{DD}	Earpiece Quiescent Current	EP ON only	4.4		mA
AUXI _{DD}	AUXOUT Quiescent Current	AUXOUT ON only	4.8		mA
CPOUTI _{DD}	CPOUT Quiescent Current	CPOUT ON only	4.8		mA
LOUDSPEAKER AMPLIFIER					
P _{LS}	Max Loudspeaker Power	8Ω load, LS_V _{DD} = 5V	1.3		W
		8Ω load, LS_V _{DD} = 4.2V	0.9		W
		8Ω load, LS_V _{DD} = 3.3V	0.6	0.44	W (min)
LS _{THD+N}	Loudspeaker Harmonic Distortion	8Ω load, LS_V _{DD} = 3.3V, P _O = 400mW	0.4		%
LS _{EFF}	Efficiency	0 dB Input MCLK = 12.000 MHz	84		%
PSRR _{LS}	Power Supply Rejection Ratio (Loudspeaker)	AUX inputs terminated C _{BYPASS} = 1.0 μF V _{RIPPLE} = 200 mV _{P-P} f _{RIPPLE} = 217 Hz	54		dB
SNR _{LS}	Signal to Noise Ratio	From 0 dB Analog AUX input at 1 kHz, A-weighted	76		dB
e _N	Output Noise	A-weighted	350		μV
V _{OS}	Offset Voltage		7		mV
HEADPHONE AMPLIFIER					
P _{HP}	Headphone Power	32Ω load, 3.3V, SE	33	20	mW (min)
		16Ω load, 3.3V, SE	52		mW
		32Ω load, 3.3V, OCL, VCM = 1.5V	31		mW
		32Ω load, 3.3V, OCL, VCM = 1.2V	20		mW
		16Ω load, 3.3V, OCL, VCM = 1.5V	50		mW
		16Ω load, 3.3V, OCL, VCM = 1.2V	32		mW
PSRR _{HP}	Power Supply Rejection Ratio (Headphones)	AUX inputs terminated C _{BYPASS} = 1.0 μF V _{RIPPLE} = 200 mV _{P-P} f _{RIPPLE} = 217 Hz			
		SE Mode	60		dB
		OCL Mode VCM = 1.2V	68		dB
		OCL Mode VCM = 1.5V	65		dB

10.0 Electrical Characteristics (Notes 1, 2) Unless otherwise stated $PLL_V_{DD} = 3.3V$, $D_V_{DD} = 3.3V$, $BB_V_{DD} = 1.8V$, $A_V_{DD} = 3.3V$, $LS_V_{DD} = 3.3V$. The following specifications apply for the circuit shown in *Figure 2* unless otherwise stated. Limits apply for 25°C. (Continued)

Symbol	Parameter	Conditions	LM4935		Units
			Typical (Note 6)	Limit (Note 7)	
HEADPHONE AMPLIFIER					
SNR _{HP}	Signal to Noise Ratio	From 0dB Analog AUX input A-weighted			
		SE Mode	98		dB
		OCL Mode VCM = 1.2V	97		dB
		OCL Mode VCM = 1.5V	96		dB
HP _{THD+N}	Headphone Harmonic Distortion	32Ω load, 3.3V, P _O = 7.5mW	0.05		%
e _N	Output Noise	A-weighted	12		μV
ΔA _{CH-CH}	Stereo Channel-to-Channel Gain Mismatch		0.3		dB
X _{TALK}	Stereo Crosstalk	SE Mode	61		dB
		OCL Mode	63		dB
EARPIECE AMPLIFIER					
P _{EP}	Earpiece Power	32Ω load, 3.3V	115	100	mW (min)
		16Ω load, 3.3V	150		mW
PSRR _{EP}	Power Supply Rejection Ratio (Earpiece)	AUX inputs terminated C _{BYPASS} = 1.0 μF V _{RIPPLE} = 200 mV _{P-P} F _{RIPPLE} = 217 Hz	65		dB
SNR _{EP}	Signal to Noise Ratio	From 0dB Analog AUX input, A-weighted	98		dB
EP _{THD+N}	Earpiece Harmonic Distortion	32Ω load, 3.3V, P _O = 50mW	0.04		%
e _N	Output Noise	A-weighted	24		μV
V _{OS}	Offset Voltage		15		mV
AUXOUT AMPLIFIER					
THD+N	Total Harmonic Distortion + Noise	V _O = 1V _{RMS} , 5kΩ load	0.02		%
PSRR	Power Supply Rejection Ratio	AUX inputs terminated C _{BYPASS} = 1.0μF V _{RIPPLE} = 200mVPP f _{RIPPLE} = 217Hz	70		dB
CP_OUT AMPLIFIER					
THD+N	Total Harmonic Distortion + Noise	V _O = 1V _{RMS} , 5kΩ load	0.02		%
PSRR	Power Supply Rejection Ratio	C _{BYPASS} = 1.0μF V _{RIPPLE} = 200mVPP f _{RIPPLE} = 217Hz	68		dB
MONO ADC					
R _{ADC}	ADC Ripple		±0.25		dB
PB _{ADC}	ADC Passband	Lower (HPF Mode 1), f _S = 8 kHz	300		Hz
		Upper	3470		Hz
SBA _{ADC}	ADC Stopband Attenuation	Above Passband	60		dB
		HPF Notch, 50 Hz/60 Hz (worst case)	58		dB
SNR _{ADC}	ADC Signal to Noise Ratio	From CPI, A-weighted	90		dB
ADC _{LEVEL}	ADC Full Scale Input Level		1		V _{RMS}

10.0 Electrical Characteristics (Notes 1, 2) Unless otherwise stated $PLL_V_{DD} = 3.3V$, $D_V_{DD} = 3.3V$, $BB_V_{DD} = 1.8V$, $A_V_{DD} = 3.3V$, $LS_V_{DD} = 3.3V$. The following specifications apply for the circuit shown in *Figure 2* unless otherwise stated. Limits apply for 25°C. (Continued)

Symbol	Parameter	Conditions	LM4935		Units
			Typical (Note 6)	Limit (Note 7)	
STEREO DAC					
R_{DAC}	DAC Ripple		0.1		dB
PB_{DAC}	DAC Passband		20		kHz
SBA_{DAC}	DAC Stopband Attenuation		70		dB
SNR_{DAC}	DAC Signal to Noise Ratio	A-weighted, AUXOUT	88		dB
DR_{DAC}	DAC Dynamic Range		96		dB
DAC_{LEVEL}	DAC Full Scale Output Level		1		V_{RMS}
PLL					
F_{IN}	Input Frequency Range	Min	0.5		MHz
		Max	30		MHz
I2S/PCM					
f_{I2SCLK}	I2S CLK Frequency	$f_S = 48kHz$; 16 bit mode	1.536		MHz
		$f_S = 48kHz$; 25 bit mode	2.4		MHz
		$f_S = 8kHz$; 16 bit mode	0.256		MHz
		$f_S = 8kHz$; 25 bit mode	0.4		MHz
f_{PCMCLK}	PCM CLK Frequency	$f_S = 48kHz$; 16 bit mode	0.768		MHz
		$f_S = 48kHz$; 25 bit mode	1.2		MHz
		$f_S = 8kHz$; 16 bit mode	0.128		MHz
		$f_S = 8kHz$; 25 bit mode	0.2		MHz
DC_{I2S_CLK}	I2S_CLK Duty Cycle	Min		40	% (min)
		Max		60	% (max)
DC_{I2S_WS}	I2S_WS Duty Cycle		50		%
I2C					
T_{I2CSET}	I2C Data Setup Time	Refer to Pg. 18 for more details		100	ns (min)
$T_{I2CHOLD}$	I2C Data Hold Time	Refer to Pg. 18 for more details		300	ns (min)
SPI					
$T_{SPISETENB}$	Enable Setup Time			100	ns (min)
$T_{SPIHOLD-ENB}$	Enable Hold Time			100	ns (min)
$T_{SPISETD}$	Data Setup Time			100	ns (min)
$T_{SPIHOLD}$	Data Hold Time			100	ns (min)
T_{SPICL}	Clock Low Time			500	ns (min)
T_{SPICH}	Clock High Time			500	ns (min)
VOLUME CONTROL					
VCR_{AUX}	AUX Volume Control Range	Minimum Gain w/ AUX_BOOST OFF	-46.5		dB
		Maximum Gain w/ AUX_BOOST OFF	0		dB
		Minimum Gain w/ AUX_BOOST ON	-34.5		dB
		Maximum Gain w/ AUX_BOOST ON	12		dB
VCR_{DAC}	DAC Volume Control Range	Minimum Gain w/ DAC_BOOST OFF	-46.5		dB
		Maximum Gain w/ DAC_BOOST OFF	0		dB
		Minimum Gain w/ DAC_BOOST ON	-34.5		dB
		Maximum Gain w/ DAC_BOOST ON	12		dB
VCR_{CPIN}	CPIN Volume Control Range	Minimum Gain	-34.5		dB
		Maximum Gain	12		dB

10.0 Electrical Characteristics (Notes 1, 2) Unless otherwise stated $PLL_V_{DD} = 3.3V$, $D_V_{DD} = 3.3V$, $BB_V_{DD} = 1.8V$, $A_V_{DD} = 3.3V$, $LS_V_{DD} = 3.3V$. The following specifications apply for the circuit shown in *Figure 2* unless otherwise stated. Limits apply for 25°C. (Continued)

Symbol	Parameter	Conditions	LM4935		Units
			Typical (Note 6)	Limit (Note 7)	
VOLUME CONTROL					
VCR _{MIC}	MIC Volume Control Range	Minimum Gain	6		dB
		Maximum Gain	36		dB
VCR _{SIDE}	SIDETONE Volume Control Range	Minimum Gain	-30		dB
		Maximum Gain	0		dB
SS _{AUX}	AUX VCR Stepsize		1.5		dB
SS _{DAC}	DAC VCR Stepsize		1.5		dB
SS _{CPIN}	CPIN VCR Stepsize		1.5		dB
SS _{MIC}	MIC VCR Stepsize		2		dB
SS _{SIDE}	SIDETONE VCR Stepsize		3		dB

10.0 Electrical Characteristics (Notes 1, 2) Unless otherwise stated $PLL_V_{DD} = 3.3V$, $D_V_{DD} = 3.3V$, $BB_V_{DD} = 1.8V$, $A_V_{DD} = 3.3V$, $LS_V_{DD} = 3.3V$. The following specifications apply for the circuit shown in *Figure 2* unless otherwise stated. Limits apply for 25°C. (Continued)

Symbol	Parameter	Conditions	LM4935		Units
			Typical (Note 6)	Limit (Note 7)	
AUDIO PATH GAIN W/ STEREO (bit 6 of 0x00h) ENABLED (AUX_L & AUX_R signals identical and selected onto mixer)					
	Loudspeaker Audio Path Gain	Minimum Gain from AUX input, BOOST OFF	-34.5		dB
		Maximum Gain from AUX input, BOOST OFF	12		dB
		Minimum Gain from CPI input	-22.5		dB
		Maximum Gain from CPI input	24		dB
	Headphone Audio Path Gain	Minimum Gain from AUX input, BOOST OFF	-52.5		dB
		Maximum Gain from AUX input, BOOST OFF	-6		dB
		Minimum Gain from CPI input	-40.5		dB
		Maximum Gain from CPI input	6		dB
		Minimum Gain from MIC input using SIDETONE path w/ VCR_{MIC} gain = 6dB	-30		dB
		Maximum Gain from MIC input using SIDETONE path w/ VCR_{MIC} gain = 6dB	0		dB
	Earpiece Audio Path Gain	Minimum Gain from AUX input, BOOST OFF	-40.5		dB
		Maximum Gain from AUX input, BOOST OFF	6		dB
		Minimum Gain from CPI input	-28.5		dB
		Maximum Gain from CPI input	18		dB
		Minimum Gain from MIC input using SIDETONE path w/ VCR_{MIC} gain = 6dB	-18		dB
		Maximum Gain from MIC input using SIDETONE path w/ VCR_{MIC} gain = 6dB	12		dB
	AUXOUT Audio Path Gain	Minimum Gain from AUX input, BOOST OFF	-46.5		dB
		Maximum Gain from AUX input, BOOST OFF	0		dB
		Minimum Gain from CPI input	-34.5		dB
		Maximum Gain from CPI input	12		dB
	CPOUT Audio Path Gain	Minimum Gain from AUX input, BOOST OFF	-46.5		dB
		Maximum Gain from AUX input, BOOST OFF	0		dB
		Minimum Gain from MIC input	6		dB
		Maximum Gain from MIC input	36		dB

10.0 Electrical Characteristics (Notes 1, 2) Unless otherwise stated $PLL_V_{DD} = 3.3V$, $D_V_{DD} = 3.3V$, $BB_V_{DD} = 1.8V$, $A_V_{DD} = 3.3V$, $LS_V_{DD} = 3.3V$. The following specifications apply for the circuit shown in *Figure 2* unless otherwise stated. Limits apply for 25°C. (Continued)

Symbol	Parameter	Conditions	LM4935		Units
			Typical (Note 6)	Limit (Note 7)	
Total DC Power Dissipation					
	MP3 Mode Power Dissipation	DAC ($f_S = 48kHz$) and HP ON			
		$f_{MCLK} = 12MHz$, PLL OFF	57		mW
		$f_{MCLK} = 13MHz$, PLL ON $f_{PLLUOUT} = 12MHz$	63		mW
		$f_{MCLK} = 19.2MHz$, PLL ON $f_{PLLUOUT} = 12MHz$	64		mW
	FM Mode Power Dissipation	AUX Inputs selected and HP ON			
		$f_{MCLK} = 12MHz$, PLL OFF	24		mW
		$f_{MCLK} = 13MHz$, PLL OFF	25		mW
		$f_{MCLK} = 19.2MHz$, PLL OFF	27		mW
	VOICE CODEC Mode Power Dissipation	PCM DAC ($f_S = 8kHz$) + ADC ($f_S = 8kHz$) and EP ON			
		$f_{MCLK} = 12MHz$, PLL OFF	49		mW
		$f_{MCLK} = 13MHz$, PLL OFF	50		mW
		$f_{MCLK} = 19.2MHz$, PLL ON $f_{PLLUOUT} = 12MHz$	56		mW
	VOICE Module Mode Power Dissipation	CP IN selected. EP and CPOUT ON			
		$f_{MCLK} = 12MHz$, PLL OFF	30		mW
		$f_{MCLK} = 13MHz$, PLL OFF	31		mW
		$f_{MCLK} = 19.2MHz$, PLL OFF	33		mW

10.0 Electrical Characteristics (Notes 1, 2) Unless otherwise stated $PLL_V_{DD} = 3.3V$, $D_V_{DD} = 3.3V$, $BB_V_{DD} = 1.8V$, $A_V_{DD} = 3.3V$, $LS_V_{DD} = 3.3V$. The following specifications apply for the circuit shown in *Figure 2* unless otherwise stated. Limits apply for 25°C. (Continued)

Note 1: Absolute Maximum Ratings indicate limits beyond which damage to the device may occur. Operating Ratings indicate conditions for which the device is functional but do not guarantee specific performance limits.

Characteristics state DC and AC electrical specifications under particular test conditions which guarantee specific performance limits. This assumes that the device is within the Operating Ratings. Specifications are not guaranteed for parameters where no limit is given, however, the typical value is a good indication of device performance.

Note 2: All voltages are measured with respect to the relevant V_{SS} pin unless otherwise specified. All grounds should be coupled as close as possible to the device.

Note 3: The maximum power dissipation must be de-rated at elevated temperatures and is dictated by T_{JMAX} , θ_{JA} , and the ambient temperature, T_A . The maximum allowable power dissipation is $P_{DMAX} = (T_{JMAX} - T_A) / \theta_{JA}$ or the number given in Absolute Maximum Ratings, whichever is lower.

Note 4: Human body model: 100pF discharged through a 1.5k Ω resistor.

Note 5: Machine model: 220pF – 240pF discharged through all pins.

Note 6: Typical values are measured at 25°C and represent the parametric norm.

Note 7: Limits are guaranteed to Nationals AOQL (Average Outgoing Quality Level).

Note 8: Best operation is achieved by maintaining $3.0V < A_V_{DD} < 5.0$ and $3.0V < D_V_{DD} < 3.6V$ and $A_V_{DD} > D_V_{DD}$.

Note 9: Digital shutdown current is measured with system clock set for PLL output while the PLL is disabled.

Note 10: Disabling or bypassing the PLL will usually result in an improvement in noise measurements.

11.0 System Control

Method 1. I²C Compatible Interface

11.1 I²C SIGNALS

In I²C mode the LM4935 pin SCL is used for the I²C clock SCL and the pin SDA is used for the I²C data signal SDA. Both these signals need a pull-up resistor according to I²C specification. The I²C slave address for LM4935 is **0011010₂**.

11.2 I²C DATA VALIDITY

The data on SDA line must be stable during the HIGH period of the clock signal (SCL). In other words, state of the data line can only be changed when SCL is LOW.

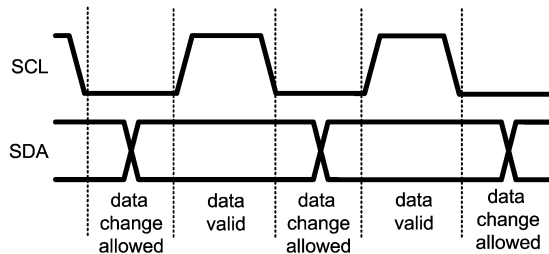

201341Q1

I²C Signals: Data Validity

11.3 I²C START AND STOP CONDITIONS

START and STOP bits classify the beginning and the end of the I²C session. START condition is defined as SDA signal transitioning from HIGH to LOW while SCL line is HIGH. STOP condition is defined as the SDA transitioning from LOW to HIGH while SCL is HIGH. The I²C master always generates START and STOP bits. The I²C bus is considered to be busy after START condition and free after STOP condition. During data transmission, I²C master can generate repeated START conditions. First START and repeated START conditions are equivalent, function-wise.

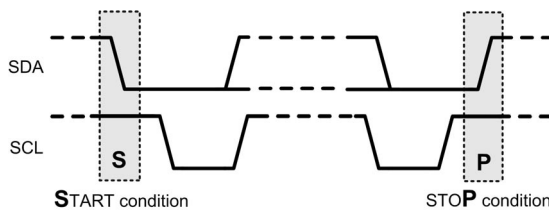

201341Q2

11.4 TRANSFERRING DATA

Every byte put on the SDA line must be eight bits long, with the most significant bit (MSB) being transferred first. Each byte of data has to be followed by an acknowledge bit. The acknowledge related clock pulse is generated by the master. The transmitter releases the SDA line (HIGH) during the acknowledge clock pulse. The receiver must pull down the SDA line during the 9th clock pulse, signifying an acknowledge. A receiver which has been addressed must generate an acknowledge after each byte has been received.

After the START condition, the I²C master sends a chip address. This address is seven bits long followed by an eighth bit which is a data direction bit (R/W). The LM4935 address is **0011010₂**. For the eighth bit, a "0" indicates a WRITE and a "1" indicates a READ. The second byte selects the register to which the data will be written. The third byte contains data to write to the selected register.

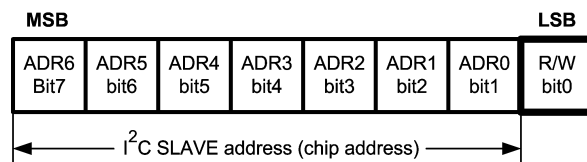

201341Q3

I²C Chip Address

Register changes take an effect at the SCL rising edge during the last ACK from slave.

11.0 System Control (Continued)

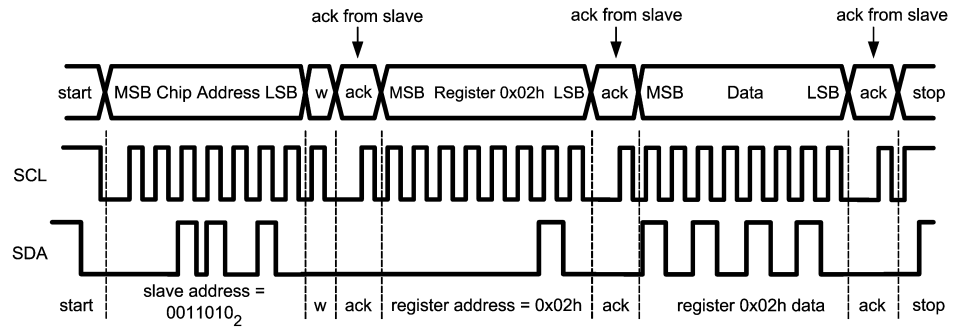

201341Q5

w = write (SDA = "0")
 r = read (SDA = "1")
 ack = acknowledge (SDA pulled down by slave)
 rs = repeated start

Example I²C Write Cycle

11.0 System Control (Continued)

When a READ function is to be accomplished, a WRITE function must precede the READ function, as shown in the Read Cycle waveform.

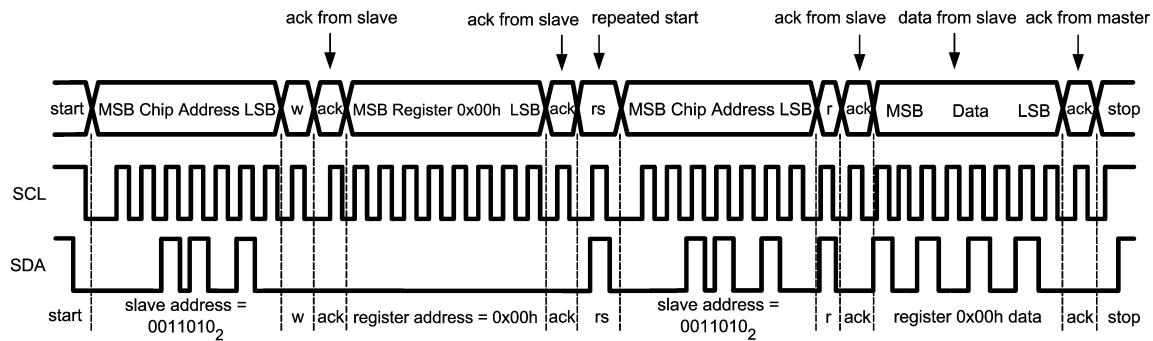

201341Q6

Example I²C Read Cycle

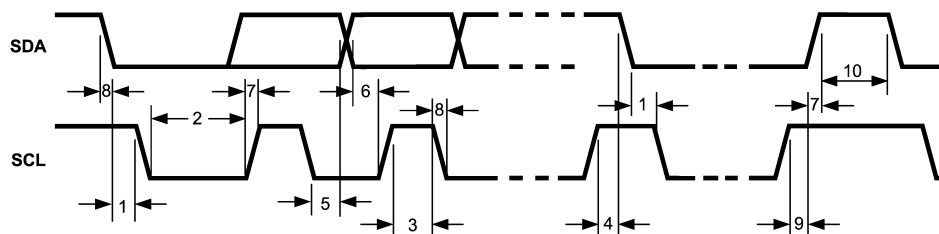

201341P9

I²C Timing Diagram

11.5 I²C TIMING PARAMETERS

Symbol	Parameter	Limit		Units
		Min	Max	
1	Hold Time (repeated) START Condition	0.6		μs
2	Clock Low Time	1.3		μs
3	Clock High Time	600		ns
4	Setup Time for a Repeated START Condition	600		ns
5	Data Hold Time (Output direction, delay generated by LM4935)	300	900	ns
5	Data Hold Time (Input direction, delay generated by the Master)	0	900	ns
6	Data Setup Time	100		ns
7	Rise Time of SDA and SCL	$20+0.1C_b$	300	ns
8	Fall Time of SDA and SCL	$15+0.1C_b$	300	ns
9	Set-up Time for STOP condition	600		ns
10	Bus Free Time between a STOP and a START Condition	1.3		μs
C_b	Capacitive Load for Each Bus Line	10	200	pF

NOTE: Data guaranteed by design

11.0 System Control (Continued)

Method 2. SPI/Microwire Control/3-wire Control

The LM4935 can be controlled via a three wire interface consisting of a clock, data and an active low chip_select. To use this control method connect SPI_MODE to BB_V_{DD} and use TEST_MODE/ \overline{CS} as the chip_select as follows:

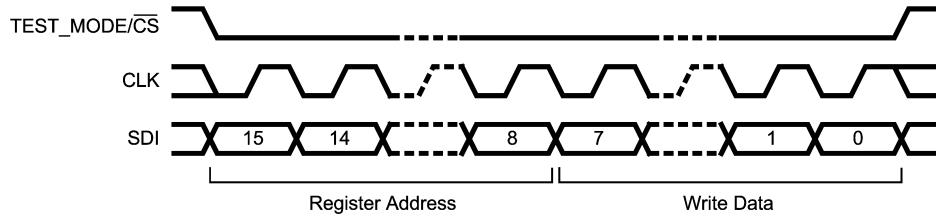

20134106

FIGURE 3. SPI Write Transaction

If the application requires read access to the register set; for example to determine the cause of an interrupt request or to read back a SAR data field, the GPIO2 pin can be configured as an SPI format serial data output by setting the GPIO_SEL in the GPIO configuration register (0x1Ah) to SPI_SDO. To perform a read rather than a write to a particular address the MSB of the register address field is set to a 1, this effectively mirrors the contents of the register field to read-only locations above 0x80h:

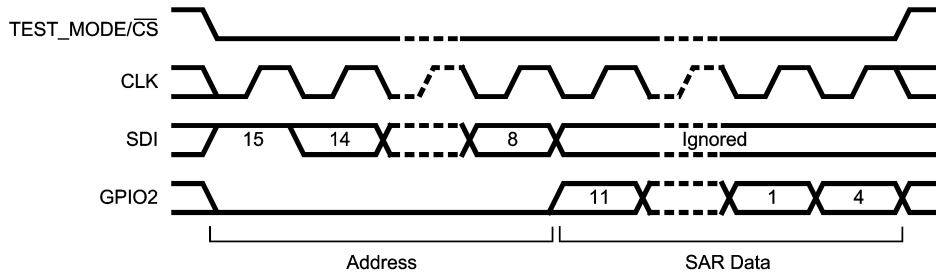

20134107

FIGURE 4. SPI Read Transaction

Three Wire Mode Write Bus Timing

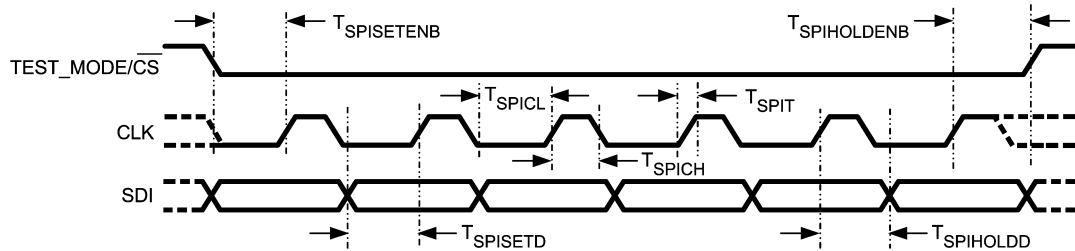

20134109

FIGURE 5. SPI Timing

12.0 Status & Control Registers

TABLE 1. Register Map

Address	Register	7	6	5	4	3	2	1	0
0x00h	BASIC	OCL	STEREO	CAP_SIZE		USE_OSC	PLL_ENB	CHP_MODE	
0x01h	CLOCKS	R_DIV						ADCLK	DACCLK
0x02h	PLL_M	PLLINPUT	PLL_M						RSVD
0x03h	PLL_N	PLL_N							
0x04h	PLL_P	RSVD	Q_DIV			PLL_P		RSVD	
0x05h	PLL_MOD	RSVD	DITHER_LEVEL		PLL_N_MOD				
0x06h	ADC_1	HPF_MODE		SAMPLE_RATE		RIGHT	LEFT	CPI	MIC
0x07h	ADC_2	IF216	ADC_I2SM	AGC_FRAME_TIME			ADCMUTE	COMPND	U/ALAW
0x08h	AGC_1	NOISE_GATE_THRESHOLD			NG_ON	AGC_TARGET			AGC_ENB
0x09h	AGC_2	AGC_TIGHT	AGC_DECAY			AGC_MAX_GAIN			
0x0Ah	AGC_3	AGC_ATTACK			AGC_HOLD_TIME				
0x0Bh	MIC_1		INT_EXT	SE_DIFF	MUTE	PREAMP_GAIN			
0x0Ch	MIC_2			BTN_DEBOUNCE_TIME		BTNTYPE	MIC_BIAS_VOLTAGE	VCMVOLT	
0x0Dh	SIDETONE					SIDETONE_ATTEN			
0x0Eh	CP_INPUT			MUTE	CPI_LEVEL				
0x0Fh	AUX_LEFT	AUX_DAC	MUTE	BOOST	AUX_LEFT_LEVEL				
0x10h	AUX_RIGHT	AUX_DAC	MUTE	BOOST	AUX_RIGHT_LEVEL				
0x11h	DAC	DACMUTE	BOOST	USAXLVL	DAC_LEVEL				
0x12h	CP_OUTPUT				MICGATE	MUTE	LEFT	RIGHT	MIC
0x13h	AUX OUTPUT					MUTE	LEFT	RIGHT	CPI
0x14h	LS_OUTPUT					MUTE	LEFT	RIGHT	CPI
0x15h	HP_OUTPUT				MUTE	LEFT	RIGHT	CPI	SIDE
0x16h	EP_OUTPUT				MUTE	LEFT	RIGHT	CPI	SIDE
0x17h	DETECT		HS_DBNC_TIME				TEMP_INT	BTN_INT	DET_INT
0x18h	STATUS	GPIN	TEMP	SARTRG2	SARTRG1	BTN	MIC	STEREO	HEADSET
0x19h	AUDIO_IF	I2S_SDO_DATA		PCMCLMS	PCMSYMS	I2SCLKMS	I2SWSMS	AUDIO_IF_MODE	
0x1Ah	GPIO	GPIODATA	PCM_LNG	I2S_MODE	SAR_CH_SEL		GPIO_SEL		
0x1Bh	SAR_SLT0/1	SLT1ENB		SLOT1_FS		SLT0ENB	SLOT0_FS		
0x1Ch	SAR_SLT2/3			SLT2VBB	SLT3ENB	SLT2ENB	SLOT2_FS		
0x1Dh	SAR_DATA_0	SLOT0_DATA							
0x1Eh	SAR_DATA_1	SLOT1_DATA							
0x1Fh	SAR_DATA_2	SLOT2_DATA							
0x20h	SAR_DATA_3	SLOT3_DATA							
0x21h	DC_VOL					MAX_LVL	EFFECT	DCVLENB	
0x22h	TRIG_1	TRIG_1 [3:0]				SOURCE	DIR	ENB	
0x23h	TRIG_1_MSB	TRIG_1 [11:4]							
0x24h	TRIG_2	TRIG_2 [3:0]				SOURCE	DIR	ENB	
0x25h	TRIG_2_MSB	TRIG_2 [11:4]							
0x26h	DEBUG	GPIO_TEST_MODE	RSVD	RSVD	RSVD	SOFT RESET	RSVD	RSVD	RSVD

For all registers, the default setting of data bits 7 through 0 are all set to zero.

RESERVED bits should always be set to zero.

12.0 Status & Control Registers (Continued)

12.1 BASIC CONFIGURATION REGISTER

This register is used to control the basic function of the chip.

TABLE 2. BASIC (0x00h)

Bits	Field	Description																				
1:0	CHIP_MODE	The LM4935 can be placed in one of four modes which dictate its basic operation. When a new mode is selected the LM4935 will change operation silently and will re-configure the power management profile automatically. The modes are described as follows:																				
		<table border="1"> <thead> <tr> <th>CHIP MODE</th> <th>Audio System</th> <th>Detection System</th> <th>Typical Application</th> </tr> </thead> <tbody> <tr> <td>00₂</td> <td>Off</td> <td>Off</td> <td>Power-down Mode</td> </tr> <tr> <td>01₂</td> <td>Off</td> <td>On</td> <td>Stand-by mode with headset event detection</td> </tr> <tr> <td>10₂</td> <td>On</td> <td>Off</td> <td>Active without headset event detection</td> </tr> <tr> <td>11₂</td> <td>On</td> <td>On</td> <td>Active with headset event detection</td> </tr> </tbody> </table>	CHIP MODE	Audio System	Detection System	Typical Application	00 ₂	Off	Off	Power-down Mode	01 ₂	Off	On	Stand-by mode with headset event detection	10 ₂	On	Off	Active without headset event detection	11 ₂	On	On	Active with headset event detection
		CHIP MODE	Audio System	Detection System	Typical Application																	
		00 ₂	Off	Off	Power-down Mode																	
		01 ₂	Off	On	Stand-by mode with headset event detection																	
10 ₂	On	Off	Active without headset event detection																			
11 ₂	On	On	Active with headset event detection																			
2	PLL_ENABLE	If set the PLL can be used.																				
3	USE_OSC	If set the power management and control circuits will assume that no external clock is available and will resort to using an on-chip oscillator for SAR, headset detection and analog power management functions such as click and pop.																				
5:4	CAP_SIZE	Programs the extra delays required to stabilize once charge/discharge is complete, based on the size of the bypass capacitor.																				
		<table border="1"> <thead> <tr> <th>CAP_SIZE</th> <th>Bypass Capacitor Size</th> <th>Turn-off/on time</th> </tr> </thead> <tbody> <tr> <td>00₂</td> <td>0.1 μF</td> <td>45 ms/75 ms</td> </tr> <tr> <td>01₂</td> <td>1 μF</td> <td>45 ms/140 ms</td> </tr> <tr> <td>10₂</td> <td>2.2 μF</td> <td>45 ms/260 ms</td> </tr> <tr> <td>11₂</td> <td>4.7 μF</td> <td>45 ms/500 ms</td> </tr> </tbody> </table>	CAP_SIZE	Bypass Capacitor Size	Turn-off/on time	00 ₂	0.1 μ F	45 ms/75 ms	01 ₂	1 μ F	45 ms/140 ms	10 ₂	2.2 μ F	45 ms/260 ms	11 ₂	4.7 μ F	45 ms/500 ms					
		CAP_SIZE	Bypass Capacitor Size	Turn-off/on time																		
		00 ₂	0.1 μ F	45 ms/75 ms																		
		01 ₂	1 μ F	45 ms/140 ms																		
10 ₂	2.2 μ F	45 ms/260 ms																				
11 ₂	4.7 μ F	45 ms/500 ms																				
6	STEREO	If set, the mixers assume that the signals on the left and right internal busses are highly correlated and when these signals are combined their levels are reduced by 6 dB to allow enough headroom for them to be summed at the Loudspeaker, Earpiece, CPOUT, and AUXOUT amplifiers. For the Headphone amplifier, if this bit is set, the left and right signal levels are routed to the corresponding left or right headphone output; if this bit is cleared, the left and the right signals are added and routed to both headphone outputs and their levels are reduced by 6dB to allow enough headroom.																				
7	OCL	If set the part is placed in OCL (Output Capacitor Less) mode.																				

For reliable headset / push button detection the following bits should be defined before enabling the headset detection system by setting bit 0 of CHIP_MODE:

The OCL-bit (Cap / Capless headphone interface; bit 7 of this register)

The headset insert/removal debounce settings (bits 6:3 of DETECT (0x17h))

The BTN_TYPE-bit (Parallel / Series push button type; bit 3 MIC_2 register (0x0Ch))

The parallel push button debounce settings (bits 5:4 of MIC_2 register (0x0Ch))

All register fields controlling the audio system should be defined before setting bit 1 of CHIP_MODE and should not be altered while the audio sub-system is active.

If the analog or digital levels are below -12 dB then it is not necessary to set the stereo bit allowing greater output levels to be obtained for such signals.

12.0 Status & Control Registers (Continued)

12.2 CLOCKS CONFIGURATION REGISTER

This register is used to control the clocks throughout the chip.

TABLE 3. CLOCKS (0x01h)

Bits	Field	Description	
0	DAC_CLK	Selects the clock to be used by the audio DAC system.	
		DAC_CLK	DAC Input Source
		0	PLL Input (MCLK or I2S_CLK)
		1	PLL Output
1	ADC_CLK	Selects the clock to be used by the audio ADC system.	
		ADC_CLK	Audio ADC Input Source
		0	MCLK
		1	PLL Output
7:2	R_DIV	Programs the R divider (divides from an expected 12.000 MHz input).	
		R_DIV	Divide Value
		0	Bypass
		1	Bypass
		2	1.5
		3	2
		4	2.5
		5	3
		6	3.5
		7	4
		8	4.5
		9	5
		10	5.5
		11	6
		12	6.5
		13 to 61	7 to 31
62	31.5		
63	32		

12.0 Status & Control Registers (Continued)

12.3 LM4935 CLOCK NETWORK

The audio ADC operates at $125 \cdot f_s$, so it requires a 1.000 MHz clock to sample at 8 kHz (at point **C** as marked on the following diagram). The stereo DAC operates at $250 \cdot f_s$, i.e. 12.000 MHz (at point **B**) for 48 kHz data. It is expected that the PLL is used to drive the audio system unless a 12.000 MHz master clock is supplied and the sample rate is always a multiple of 8 kHz, in which case the PLL can be bypassed to reduce power, clock division instead being performed by the Q and R dividers. The PLL can also use the I2S clock input as a source. In this case, the audio DAC uses the clock from the output of the PLL and the audio ADC either uses the PLL output divided by $2 \cdot \text{FSDAC}/\text{FSADC}$ or a system clock divided by Q, this allows $n \cdot 8$ kHz recording and 44.1 kHz playback.

MCLK must be less than or equal to 30 MHz, the I2S clock should be an integer multiple of the DAC's sampling frequency and should be below 6 MHz.

When using the Class D amplifier with the DAC the Class D clock generator will assume 12 MHz at point **A**, if this is not the case then the DAC and power stage may become unsynchronized and SNR performance may be reduced.

The LM4935 is designed to work from a 12.000 MHz or 11.025 MHz clock at point **A**. This is used to drive the power management and control logic. Performance may not meet the electrical specifications if the frequency at this point deviates significantly beyond this range.

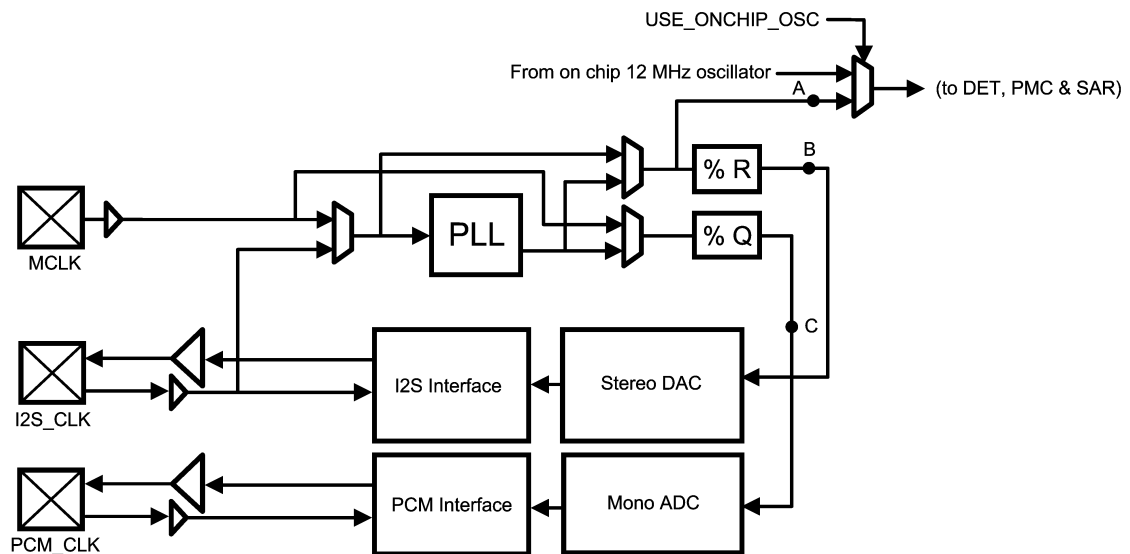

20134110

FIGURE 6. LM4935 Clock Network

12.0 Status & Control Registers (Continued)

12.4 COMMON CLOCK SETTINGS FOR THE DAC & ADC

The DAC has an over sampling rate of 125 but requires a $250 \times f_s$ clock at point **B**. This allows a simple clocking solution as it will work from 12.000 MHz (common in most systems with Bluetooth or USB) at 48 kHz exactly, the following table describes the clock required at point **B** for various clock sample rates in the different DAC modes:

TABLE 4. Common DAC Clock Frequencies

DAC Sample Rate (kHz)	Clock Required at B (MHz)
8	2
11.025	2.75625
12	3
16	4
22.05	5.5125
24	6
32	8
44.1	11.025
48	12

The ADC has an over sampling ratio of 125 so the table below shows the required clock frequency at point **C**.

TABLE 5. Common ADC Clock Frequencies

ADC Sample Rate (kHz)	Clock Required at C (MHz)
8	1
11.025	1.378125
12	1.5
16	2
22.05	2.75625
24	3

Methods for producing these clock frequencies are described in the PLL Section.

12.0 Status & Control Registers (Continued)

12.5 PLL M DIVIDER CONFIGURATION REGISTER

This register is used to control the input section of the PLL.

TABLE 6. PLL_M (0x02h)

Bits	Field	Description	
0	RSVD	RESERVED	
6:1	PLL_M	PLL_M	Input Divider Value
		0	1
		1	2
		2	3
		3	4
		4...62	5...63
		63	64
7	PLL_INPUT	Programs the PLL input multiplexer to select between:	
		PLL_INPUT	PLL Input Source
		0	MCLK
		1	I2S_CLK

The M divider should be set such that the output of the divider is between 0.5 MHz and 5 MHz.

The division of the M divider is derived from PLL_M such that:

$$M = \text{PLL_M} + 1$$

Note 11: See **Further Notes on PLL Programming** for more detail.

12.0 Status & Control Registers (Continued)

12.6 PLL N DIVIDER CONFIGURATION REGISTER

This register is used to control the feedback divider of the PLL.

TABLE 7. PLL_N (0x03h)

Bits	Field	Description	
7:0	PLL_N	Programs the PLL feedback divider as follows:	
		PLL_N	Feedback Divider Value
		0 to 10	10
		11	11
		12	12
		13	13
		14	14
	
		249	249
250 to 255	250		

The N divider should be set such that the output of the divider is between 0.5 MHz and 5 MHz. $(F_{in}/M)*N$ will be the target resting VCO frequency, F_{VCO} . The N divider should be set such that $40 \text{ MHz} < (F_{in}/M)*N < 60 \text{ MHz}$. F_{in}/M is often referred to as F_{comp} (comparison frequency) or F_{ref} (reference frequency), in this document F_{comp} is used.

The integer division of the N divider is derived from PLL_N such that:

$$\text{For } 9 < \text{PLL_N} < 251: N = \text{PLL_N}$$

Note 12: See **Further Notes on PLL Programming** for further details.

12.0 Status & Control Registers (Continued)

12.7 PLL P DIVIDER CONFIGURATION REGISTER

This register is used to control the output divider of the PLL.

TABLE 8. PLL_P (0x04h)

Bits	Field	Description	
0	RSVD	RESERVED	
3:1	PLL_P	PLL_P	Output Divider Value
		000 ₂	1
		001 ₂	2
		010 ₂	3
		011 ₂	4
		100 ₂	5
		101 ₂	6
		110 ₂	7
6:4	Q_DIV	Programs the Q Divider (divides from an expected 12.000 MHz input).	
		Q_DIV	Divide Value
		000 ₂	2
		001 ₂	3
		010 ₂	4
		011 ₂	6
		100 ₂	8
		101 ₂	10
110 ₂	12		
111 ₂	13		
7	RSVD	RESERVED	

The division of the P divider is derived from PLL_P such that:

$$P = \text{PLL_P} + 1$$

Note 13: See **Further Notes on PLL Programming** for more details.

12.0 Status & Control Registers (Continued)

12.8 PLL N MODULUS CONFIGURATION REGISTER

This register is used to control the modulation applied to the feedback divider of the PLL.

TABLE 9. PLL_N_MOD (0x05h)

Bits	Field	Description	
4:0	PLL_N_MOD	Programs the PLL N divider's fractional component:	
		PLL_N_MOD	Fractional Addition
		0	0/32
		1	1/32
		2 to 30	2/32 to 30/32
	31	31/32	
6:5	DITHER_LEVEL	Allows control over the dither used by the N divider:	
		DITHER_LEVEL	Value
		00 ₂	Medium
		01 ₂	Small
		10 ₂	Large
	11 ₂	Off	
7	RSVD	RESERVED	

The complete N divider is a fractional divider as such:

$$N = \text{PLL_N} + \text{PLL_N_MOD}/32$$

If the modulus input is zero then the N divider is simply an integer N divider. The output from the PLL is determined by the following formula:

$$F_{\text{out}} = (F_{\text{in}} * N) / (M * P)$$

Note 14: See **Further Notes on PLL Programming** for more details.

12.0 Status & Control Registers (Continued)

12.9 FURTHER NOTES ON PLL PROGRAMMING

The sigma-delta PLL is designed to drive audio circuits requiring accurate clock frequencies of up to 30 MHz with frequency errors noise-shaped away from the audio band. The 5 bits of modulus control provide exact synchronization of 48 kHz and 44.1 kHz sample rates from any common system clock. In systems where an isochronous I2S data stream is the source of data to the DAC a clock synchronous to the sample rate should be used as input to the PLL (typically the I2S clock). If no isochronous source is available then the PLL can be used to obtain a clock that is accurate to within 1 Hz of the correct sample rate although this is highly unlikely to be a problem.

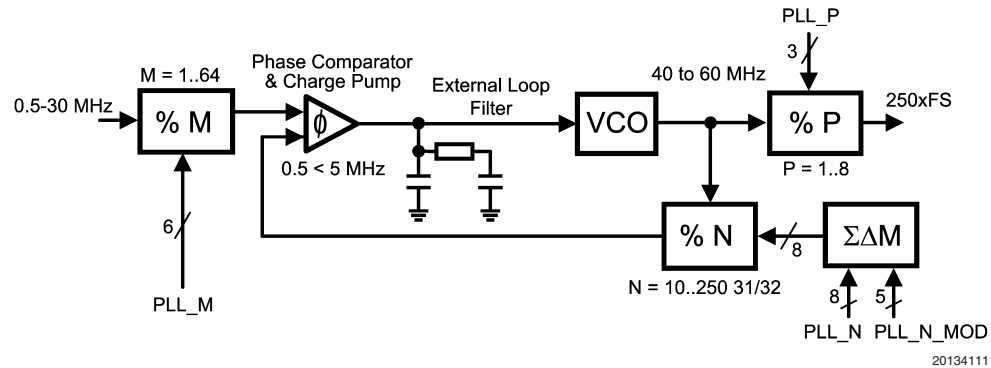

FIGURE 7. PLL Overview

TABLE 10. Example PLL Settings for 48 kHz and 44.1 kHz Sample Rates

F_{in} (MHz)	F_s (kHz)	M	N	P	PLL_M	PLL_N	PLL_N_MOD	PLL_P	F_{out} (MHz)
11	48	11	60	5	10	60	0	4	12
12.288	48	4	19.53125	5	3	19	17	4	12
13	48	13	60	5	12	60	0	4	12
14.4	48	9	37.5	5	8	37	16	4	12
16.2	48	27	100	5	26	100	0	4	12
16.8	48	14	50	5	13	50	0	4	12
19.2	48	13	40.625	5	12	40	20	4	12
19.44	48	27	100	6	26	100	0	5	12
19.68	48	21	64.03125	5	20	64	1	4	12
19.8	48	17	51.5	5	16	51	16	4	12
11	44.1	11	55.125	5	10	55	4	4	11.025
11.2896	44.1	8	39.0625	5	7	39	2	4	11.025
12	44.1	5	22.96875	5	4	22	31	4	11.025
13	44.1	13	55.125	5	12	55	4	4	11.025
14.4	44.1	12	45.9375	5	11	45	30	4	11.025
16.2	44.1	9	30.625	5	8	9	20	4	11.025
16.8	44.1	17	55.78125	5	16	30	25	4	11.025
19.2	44.1	16	45.9375	5	15	45	30	4	11.025
19.44	44.1	14	39.6875	5	13	39	22	4	11.025
19.68	44.1	21	47.0625	4	20	47	2	3	11.025
19.8	44.1	11	30.625	5	10	30	204	4	11.025

12.0 Status & Control Registers (Continued)

These tables cover the most common applications, obtaining clocks for derivative sample rates such as 22.05 kHz should be done by increasing the P divider value or using the R/Q dividers.

If the user needs to obtain a clock unrelated to those described above, the following method is advised. An example of obtaining 12.000 MHz from 1.536 MHz is shown below (this is typical for deriving DAC clocks from I2S datastreams).

Choose a small range of P so that the VCO frequency is swept between 40 MHz and 60 MHz. So for P = 3 to 5, sweep the M inputs from 1 to 3. The most accurate N and N_MOD can be calculated by:

$$N = \text{FLOOR}(((F_{\text{out}}/F_{\text{in}})*(P*M)),1)$$

$$N_MOD = \text{ROUND}(32*(((F_{\text{out}}/F_{\text{in}})*(P*M)-N),0)$$

This shows that setting M = 1, N = 39+1/16, P = 5 (i.e. PLL_M = 0, PLL_N = 39, PLL_N_MOD = 2, & PLL_P = 4) gives a comparison frequency of 1.5 MHz, a VCO frequency of 60 MHz and an output frequency of 12.000 MHz. The same settings can be used to get 11.025 from 1.4112 MHz for 44.1 kHz sample rates.

Care must be taken when synchronization of isochronous data is not possible, i.e. when the PLL has to be used but an exact frequency match cannot be found. The I2S should be master on the LM4935 so that the data source can support appropriate SRC as required. This method should only be used with data being read on demand to eliminate sample rate mismatch problems.

Where a system clock exists at an integer multiple of the required ADC or DAC clock rate it is preferable to use this rather than the PLL. The LM4935 is designed to work in 8, 12, 16, 24, 48 kHz modes from a 12 MHz clock and 8, 13, 26, 52 kHz modes from a 13 MHz clock without the use of the PLL. This saves power and reduces clock jitter which can affect SNR.

The actual ADC and DAC sample rates are set up by the PLL and internal clock dividers.

12.0 Status & Control Registers (Continued)

12.10 ADC_1 CONFIGURATION REGISTER

This register is used to control the LM4935's audio ADC.

TABLE 11. ADC_1 (0x06h)

Bits	Field	Description	
0	MIC_SELECT	If set the microphone preamp output is added to the ADC input signal.	
1	CPI_SELECT	If set the cell phone input is added to the ADC input signal.	
2	LEFT_SELECT	If set the left stereo bus is added to the ADC input signal.	
3	RIGHT_SELECT	If set the right stereo bus is added to the ADC input signal.	
5:4	ADC_SAMPLE_RATE	Programs the closest expected sample rate of the mono ADC, which is a variable required by the AGC algorithm whenever the AGC is in use. This does not set the sample rate of the mono ADC.	
		ADC_SAMPLE_RATE	Sample Rate
		00 ₂	8 kHz
		01 ₂	12 kHz
		10 ₂	16 kHz
7:6	HPF_MODE	Sets the HPF of the ADC	
		HPF-MODE	HPF Response
		00 ₂	No HPF
		01 ₂	F _S = 8 kHz, -0.5 dB @ 300 Hz, Notch @ 55 Hz F _S = 12 kHz, -0.5 dB @ 450 Hz, Notch @ 82 Hz F _S = 16 kHz, -0.5 dB @ 600 Hz, Notch @ 110 Hz
		10 ₂	F _S = 8 kHz, -0.5 dB @ 150 Hz, Notch @ 27 Hz F _S = 12 kHz, -0.5 dB @ 225 Hz, Notch @ 41 Hz F _S = 16 kHz, -0.5 dB @ 300 Hz, Notch @ 55 Hz
11 ₂	No HPF		

12.0 Status & Control Registers (Continued)

12.11 ADC_2 CONFIGURATION REGISTER

This register is used to control the LM4935's audio ADC.

TABLE 12. ADC_2 (0x07h)

Bits	Field	Description	
0	ULAW/ALAW	If COMPAND is set then the data across the PCM interface to the DAC and from the ADC is companded as follows:	
		ULAW/ALAW	Commanding Type
		0	μ -law
		1	A-law
1	COMPAND	If set the 16 bit PCM data from the ADC is companded before the PCM interface and the PCM data to the DAC is treated as companded data.	
2	ADC_MUTE	If set the analog inputs to the ADC are muted.	
5:3	AGC_FRAME_TIME	This sets the frame time to be used by the AGC algorithm. In a given frame, the AGC's peak detector determines the peak value of the incoming microphone audio signal and compares this value to the target value of the AGC defined by AGC_TARGET (bits [3:1] of register (0x08h)) in order to adjust the microphone preamplifiers gain accordingly. AGC_FRAME_TIME basically sets the sample rate of the AGC to adjust for a wide variety of speech patterns. (Note 15)	
		AGC_FRAME_TIME	Time (ms)
		000 ₂	96
		001 ₂	128
		010 ₂	192
		011 ₂	256
		100 ₂	384
		101 ₂	512
		110 ₂	768
111 ₂	1000		
6	ADC_I2S_M	If set the DAC clock system is enabled to drive the I2S in master mode. The Point B frequency should be double that at Point C. This bit should be set when using the I2S interface in master mode to read SAR information whenever both the audio ADC and DAC are inactive.	
7	AUDIO_IF_2_16BIT	If set the PCM and I2S interfaces are 16 bits per word in master mode. The 2 last clock cycles per word are 25% shorter to allow generation.	

Note 15: Refer to the **AGC overview** for further detail.

12.0 Status & Control Registers (Continued)

12.12 AGC_1 CONFIGURATION REGISTER

This register is used to control the LM4935's Automatic Gain Control. (Note 16)

TABLE 13. AGC_1 (0x08h)

Bits	Field	Description	
0	AGC_ENABLE	If set the AGC controls the analog microphone preamplifier gain into the system. The microphone input must be passed to the ADC.	
3:1	AGC_TARGET	Programs the target level of the AGC. This will depend on the expected transients and desired headroom. Refer to AGC_TIGHT (bit 7 of 0x09h) for more detail.	
		AGC_TARGET	Target Level
		000 ₂	-6 dB
		001 ₂	-8 dB
		010 ₂	-10 dB
		011 ₂	-12 dB
		100 ₂	-14 dB
		101 ₂	-16 dB
		110 ₂	-18 dB
111 ₂	-20 dB		
4	NOISE_GATE_ON	If set, signals below the noise gate threshold are muted. The noise gate is only activated after a set period of signal absence.	
7:5	NOISE_GATE_THRES	This field sets the expected background noise level relative to the peak signal level. The sole presence of signals below this level will not result in an AGC gain change of the input and will be gated from the ADC output if the NOISE_GATE_ON is set. This level must be set even if the noise gate is not in use as it is required by the AGC algorithm.	
		NOISE_GATE_THRES	Level
		000 ₂	-72 dB
		001 ₂	-66 dB
		010 ₂	-60 dB
		011 ₂	-54 dB
		100 ₂	-48 dB
		101 ₂	-42 dB
		110 ₂	-36 dB
111 ₂	-30 dB		

Note 16: See the **AGC overview**.

12.0 Status & Control Registers (Continued)

12.13 AGC_2 CONFIGURATION REGISTER

This register is used to control the LM4935's Automatic Gain Control.

TABLE 14. AGC_2 (0x09h)

Bits	Field	Description		
3:0	AGC_MAX_GAIN	This programs the maximum gain that the AGC algorithm can apply to the microphone preamplifier.		
		AGC_MAX_GAIN	Max Preamplifier Gain	
		0000 ₂	6 dB	
		0001 ₂	8 dB	
		0010 ₂	10 dB	
		0011 ₂	12 dB	
		0100 ₂ to 1100 ₂	14 dB to 30 dB	
		1101 ₂	32 dB	
		1110 ₂	34 dB	
		1111 ₂	36 dB	
6:4	AGC_DECAY	Programs the speed at which the AGC will increase gains if it detects the input level is a quiet signal.		
		AGC_DECAY	Step Time (ms)	
		000 ₂	32	
		001 ₂	64	
		010 ₂	128	
		011 ₂	256	
		100 ₂	512	
		101 ₂	1024	
		110 ₂	2048	
		111 ₂	4096	
7	AGC_TIGHT	If set the AGC algorithm controls the microphone preamplifier more exactly. (Note 17)		
	AGC_TIGHT = 0	AGC_TARGET	Min Level	Max Level
		000 ₂	-6 dB	-3 dB
		001 ₂	-8 dB	-4 dB
		010 ₂	-10 dB	-5 dB
		011 ₂	-12 dB	-6 dB
		100 ₂	-14 dB	-7 dB
		101 ₂	-16 dB	-8 dB
		110 ₂	-18 dB	-9 dB
		111 ₂	-20 dB	-10 dB
	AGC_TIGHT = 1	000 ₂	-6 dB	-3 dB
		001 ₂	-8 dB	-5 dB
		010 ₂	-10 dB	-7 dB
		011 ₂	-12 dB	-9 dB
		100 ₂	-14 dB	-11 dB
		101 ₂	-16 dB	-13 dB
		110 ₂	-18 dB	-15 dB
		111 ₂	-20 dB	-17 dB

Note 17: The AGC can be used to control the analog path of the microphone to the output stages or to optimize the microphone path for recording on the ADC. When the analog path is used this bit should be set to ensure the target is tightly adhered to. If the ADC is the only destination of the microphone or the desired analog mixer level is line level then AGC_TIGHT should be cleared, allowing greater dynamic range of the recorded signal. For further details see the **AGC overview**.

12.0 Status & Control Registers (Continued)

12.14 AGC_3 CONFIGURATION REGISTER

This register is used to control the LM4935's Automatic Gain Control. (Note 18)

TABLE 15. AGC_3 (0x0Ah)

Bits	Field	Description	
4:0	AGC_HOLDTIME	Programs the amount of delay before the AGC algorithm begins to adjust the gain of the microphone preamplifier.	
		AGC_HOLDTIME	No. of speech segments
		0000 ₂	0
		00001 ₂	1
		00010 ₂	2
		00011 ₂	3
		00100 ₂ to 11100 ₂	4 to 28
		11101 ₂	29
		11110 ₂	30
		11111 ₂	31
7:5	AGC_ATTACK	Programs the speed at which the AGC will reduce gains if it detects the input level is too large.	
		AGC_ATTACK	Step Time (ms)
		000 ₂	32
		001 ₂	64
		010 ₂	128
		011 ₂	256
		100 ₂	512
		101 ₂	1024
		110 ₂	2048
111 ₂	4096		

Note 18: See the **AGC overview**.

12.0 Status & Control Registers (Continued)

12.15 AGC OVERVIEW

The Automatic Gain Control (AGC) system can be used to optimize the dynamic range of the ADC for voice data when the level of the source is unknown. A target level for the output is set so that any transients on the input won't clip during normal operation. The AGC circuit then compares the output of the ADC to this level and increases or decreases the gain of the microphone preamplifier to compensate. If the audio from the microphone is to be output digitally through the ADC then the full dynamic range of the ADC can be used automatically. If the output is through the analog mixer then the ADC is used to monitor the microphone level. In this case, the analog dynamic range is less important than the absolute level, so *AGC_TIGHT* should be set to tie transients closely to the target level.

To ensure that the system doesn't reduce the quality of the speech by constantly modulating the microphone preamplifier gain, the ADC output is passed through an envelope detector. This frames the output of the ADC into time segments roughly equal to the phonemes found in speech (*AGC_FRAME_TIME*). To calculate this, the circuit must also know the sample rate of the data from the ADC (*ADC_SAMPLERATE*). If after a programmable number of these segments (*AGC_HOLDTIME*), the level is consistently below target, the gain will be increased at a programmable rate (*AGC_DECAY*). If the signal ever exceeds the target level (*AGC_TARGET*) then the gain of the microphone is reduced immediately at a programmable rate (*AGC_ATTACK*). This is demonstrated below:

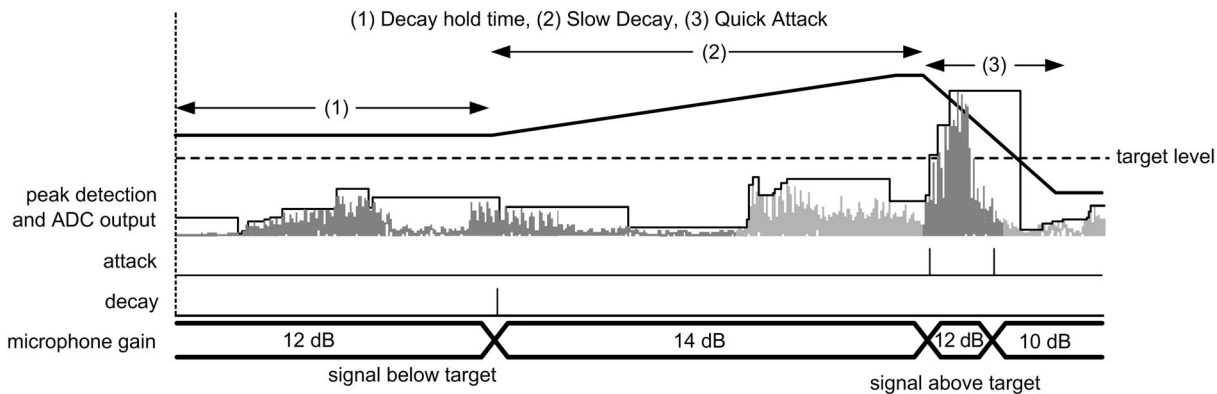

AGC Operation Example

20134112

The signal in the above example starts with a small analog input which, after the hold time has timed out, triggers a rise in the gain ((1) → (2)). After some time the real analog input increases and it reaches the threshold for a gain reduction which decreases the gain at a faster rate ((2) → (3)) to allow the elimination of typical popping noises.

Only ADC outputs that are considered signal (rather than noise) are used to adjust the microphone preamplifier gain. The signal to noise ratio of the expected input signal is set by *NOISE_GATE_THRESHOLD*. In some situations it is preferable to remove audio considered to be consisting solely of background noise from the audio output; for example conference calls. This can be done by setting *NOISE_GATE_ON*. This does not affect the performance of the AGC algorithm.

The AGC algorithm should not be used where very large background noise is present. If the type of input data, application and microphone is known then the AGC will typically not be required for good performance, it is intended for use with inputs with a large dynamic range or unknown nominal level. When setting *NOISE_GATE_THRESHOLD* be aware that in some mobile phone scenarios the ADC SNR will be dictated by the microphone performance rather than the ADC or the signal. Gain changes to the microphone are performed on zero crossings. To eliminate DC offsets, wind noise, and pop sounds from the output of the ADC, the ADC's HPF gain should always be enabled.

12.0 Status & Control Registers (Continued)

12.16 MIC_1 CONFIGURATION REGISTER

This register is used to control the microphone configuration.

TABLE 16. MIC_1 (0x0Bh)

Bits	Field	Description	
3:0	PREAMP_GAIN	Programs the gain applied to the microphone preamplifier if the AGC is not in use.	
		PREAMP_GAIN	Gain
		0000 ₂	6 dB
		0001 ₂	8 dB
		0010 ₂	10 dB
		0011 ₂	12 dB
		0100 ₂ to 1100 ₂	14 dB to 30 dB
		1101 ₂	32 dB
		1110 ₂	34 dB
	1111 ₂	36 dB	
4	MIC_MUTE	If set the microphone preamplifier is muted.	
5	INT_SE_DIFF	If set the internal microphone is assumed to be single ended and the negative connection is connected to the ADC common mode point internally. This allows a single-ended internal microphone to be used.	
6	INT_EXT	If set the single ended external microphone is used and the negative microphone input is grounded internally, otherwise internal microphone operation is assumed. (Note 19)	

Note 19: On changing INT_EXT from internal to external note that the dc blocking cap will not be charged so some time should be taken (300 ms for a 1 μ F cap) between the detection of an external headset and the switching of the output stages and ADC to that input to allow the DC points on either side of this cap to stabilize. This can be accomplished by deselecting the microphone input from the audio outputs and ADC until the DC points stabilize.

An active MIC path to CPOUT or the ADC may result in the microphone DC blocking caps causing audio pops under the following situations:

- 1) Switching between internal and external microphone operation while in chip modes '10' or '11'.
- 2) Toggling in and out of powerdown/standby modes.
- 3) Toggling between chip modes '10' and '11' whenever external microphone operation is selected.
- 4) The insertion/removal of a headset while in chip modes '10' or '11' whenever external microphone operation is selected.

To avoid these potential pop issues, it is recommended to deselect the microphone input from CPOUT and ADC until the DC points stabilize.

12.0 Status & Control Registers (Continued)

12.17 MIC_2 CONFIGURATION REGISTER

This register is used to control the microphone configuration.

TABLE 17. MIC_2 (0x0Ch)

Bits	Field	Description		
0	OCL_ VCM_ VOLTAGE	Selects the voltage used as virtual ground (HP_VMID pin) in OCL mode. This will depend on the available supply and the power output requirements of the headphone amplifiers.		
		OCL_VCM_VOLTAGE	Voltage	
		0	1.2V	
		1	1.5V	
2:1	MIC_ BIAS_ VOLTAGE	Selects the voltage as a reference to the internal and external microphones. Only one bias pin is driven at once depending on the INT_EXT bit setting found in the MIC_1 (0x0Bh) register. MIC_BIAS_VOLTAGE should be set to '11' only if A_VDD > 3.4V. In OCL mode, MIC_BIAS_VOLTAGE = '00' (EXT_BIAS = 2.0V) should not be used to generate the EXT_BIAS supply for a cellular headset external microphone. Please refer to Table 18 for more detail.		
		MIC_BIAS_VOLTAGE	EXT_BIAS	INT_BIAS
		00 ₂	2.0V	2.0V
		01 ₂	2.5V	2.5V
		10 ₂	2.8V	2.8V
11 ₂	3.3V	3.3V		
3	BUTTON_TYPE	If set the LM4935 assumes that the button (if used) in the headset is in series (series push button) with the microphone, opening the circuit when pressed. The default is for the button to be in parallel (parallel push button), shorting out the microphone when pressed.		
5:4	BUTTON_ DEBOUNCE_ TIME	Sets the time used for debouncing the pushing of the button on a headset with a parallel push button.		
		BUTTON_DEBOUNCE_TIME	Time (ms)	
		00 ₂	0	
		01 ₂	8	
		10 ₂	16	
11 ₂	32			

In OCL mode there is a trade-off between the external microphone supply voltage (EXT_MIC_BIAS - OCL_VCM_VOLTAGE) and the maximum output power possible from the headphones. A lower OCL_VCM_VOLTAGE gives a higher microphone supply voltage but a lower maximum output power from the headphone amplifiers due to the lower OCL_VCM_VOLTAGE - A_VSS.

TABLE 18. External MIC Supply Voltages in OCL Mode

Available A_VDD	Recommended EXT_MIC_BIAS	Supply to Microphone	
		OCL_VCM_VOLT = 1.5V	OCL_VCM_VOLT = 1.2V
> 3.4V	3.3V	1.8V	2.1V
2.9V to 3.4V	2.8V	1.3V	1.6V
2.8V to 2.9V	2.5V	1.0V	1.3V
2.7V to 2.8V	2.5V	-	1.3V

12.0 Status & Control Registers (Continued)

12.18 SIDETONE ATTENUATION REGISTER

This register is used to control the analog sidetone attenuation. (Note 20)

TABLE 19. SIDETONE (0x0Dh)

Bits	Field	Description	
3:0	SIDETONE_ ATTEN	Programs the attenuation applied to the microphone preamp output to produce a sidetone signal.	
		SIDETONE_ATTEN	Attenuation
		0000 ₂	-Inf
		0001 ₂	-30 dB
		0010 ₂	-27 dB
		0011 ₂	-24 dB
		0100 ₂	-21 dB
		0101 ₂ to 1010 ₂	-18 dB to -3 dB
1011 ₂ to 1111 ₂	0 dB		

Note 20: An active SIDETONE path to an audio output may result in the microphone DC blocking caps causing audio pops under the following situations:

- 1) Switching between internal and external microphone operation while in chip modes '10' or '11'.
- 2) Toggling in and out of powerdown/standby modes.
- 3) Toggling between chip modes '10' and '11' whenever external microphone operation is selected.
- 4) The insertion/removal of a headset while in chip modes '10' or '11' whenever external microphone operation is selected.

To avoid potential pop noises, it is recommended to set SIDETONE_ATTEN to '0000' until DC points have stabilized whenever the SIDETONE path is used.

12.0 Status & Control Registers (Continued)

12.19 CP_INPUT CONFIGURATION REGISTER

This register is used to control the differential cell phone input.

TABLE 20. CP_INPUT (0x0Eh)

Bits	Field	Description	
4:0	CPI_LEVEL	Programs the gain/attenuation applied to the cell phone input.	
		CPI_LEVEL	Level
		00000 ₂	-34.5 dB
		00001 ₂	-33 dB
		00010 ₂	-31.5 dB
		00011 ₂	-30 dB
		00100 to 11100 ₂	-28.5 dB to +7.5 dB
		11101 ₂	+9 dB
		11110 ₂	+10.5 dB
	11111 ₂	+12 dB	
5	CPI_MUTE	If set the CPI input is muted at source.	

12.0 Status & Control Registers (Continued)

12.20 AUX_LEFT CONFIGURATION REGISTER

This register is used to control the left aux analog input.

TABLE 21. AUX_LEFT (0x0Fh)

Bits	Field	Description		
4:0	AUX_ LEFT_ LEVEL	Programs the gain/attenuation applied to the AUX LEFT analog input to the mixer. (Note 21)		
		AUX_LEFT_LEVEL	Level (With Boost)	Level (Without Boost)
		00000 ₂	-34.5 dB	-46.5 dB
		00001 ₂	-33 dB	-45 dB
		00010 ₂	-31.5 dB	-43.5 dB
		00011 ₂	-30 dB	-42 dB
		00100 to 11100 ₂	-28.5 dB to +7.5 dB	-40.5 dB to -4.5 dB
		11101 ₂	+9 dB	-3 dB
		11110 ₂	+10.5 dB	-1.5 dB
11111 ₂	+12 dB	0 dB		
5	AUX_ LEFT_ BOOST	If set the gain of the AUX_LEFT input to the mixer is increased by 12 dB (see above).		
6	AUX_L_MUTE	If set the AUX LEFT input is muted.		
7	AUX_OR_DAC_L	If set the AUX LEFT input is passed to the mixer, the default is for the DAC LEFT output to be passed to the mixer.		

Note 21: The recommended mixer level is 1V RMS. The auxiliary analog inputs can be boosted by 12 dB if enough headroom is available. Clipping may occur if the analog power supply is insufficient to cater for the required gain.

12.0 Status & Control Registers (Continued)

12.21 AUX_RIGHT CONFIGURATION REGISTER

This register is used to control the right aux analog input.

TABLE 22. AUX_RIGHT (0x10h)

Bits	Field	Description		
4:0	AUX_RIGHT_LEVEL	Programs the gain/attenuation applied to the AUX RIGHT analog input to the mixer. (Note 22)		
		AUX_RIGHT_LEVEL	Level (With Boost)	Level (Without Boost)
		00000 ₂	-34.5 dB	-46.5 dB
		00001 ₂	-33 dB	-45 dB
		00010 ₂	-31.5 dB	-43.5 dB
		00011 ₂	-30 dB	-42 dB
		00100 to 11100 ₂	-28.5 dB to +7.5 dB	-40.5 dB to -4.5 dB
		11101 ₂	+9 dB	-3 dB
		11110 ₂	+10.5 dB	-1.5 dB
11111 ₂	+12 dB	0 dB		
5	AUX_RIGHT_BOOST	If set the gain of the AUX_RIGHT input to the mixer is increased by 12 dB (see above).		
6	AUX_R_MUTE	If set the AUX RIGHT input is muted.		
7	AUX_OR_DAC_R	If set the AUX RIGHT input is passed to the mixer, the default is for the DAC RIGHT output to be passed to the mixer.		

Note 22: The recommended mixer level is 1V RMS. The auxiliary analog inputs can be boosted by 12 dB if enough headroom is available. Clipping may occur if the analog power supply is insufficient to cater for the required gain.

12.0 Status & Control Registers (Continued)

12.22 DAC CONFIGURATION REGISTER

This register is used to control the DAC levels to the mixer.

TABLE 23. DAC (0x11h)

Bits	Field	Description		
4:0	DAC_LEVEL	Programs the gain/attenuation applied to the DAC input to the mixer. (Note 23)		
		DAC_LEVEL	Level (With Boost)	Level (Without Boost)
		00000 ₂	-34.5 dB	-46.5 dB
		00001 ₂	-33 dB	-45 dB
		00010 ₂	-31.5 dB	-43.5 dB
		00011 ₂	-30 dB	-42 dB
		00100 to 11100 ₂	-28.5 dB to +7.5 dB	-40.5 dB to -4.5 dB
		11101 ₂	+9 dB	-3 dB
		11110 ₂	+10.5 dB	-1.5 dB
11111 ₂	+12 dB	0 dB		
5	USE_AUX_LEVELS	If set the gain of the DAC inputs is controlled by the AUX_LEFT and AUX_RIGHT registers, allowing a stereo balance to be applied.		
6	BOOST	If set the gain of the DAC inputs to the mixer is increased by 12 dB (see above).		
7	DAC_MUTE	If set the stereo DAC input is muted on the next zero crossing.		

Note 23: The output from the DAC is 1V RMS for a full scale digital input. This can be boosted by 12 dB if enough headroom is available. Clipping may occur if the analog power supply is insufficient to cater for the required gain.

12.0 Status & Control Registers (Continued)

12.23 CP_OUTPUT CONFIGURATION REGISTER

This register is used to control the differential cell phone output. (Note 24)

TABLE 24. CP_OUTPUT (0x12h)

Bits	Field	Description
0	MIC_SELECT	If set the microphone channel of the mixer is added to the cellphone output signal.
1	RIGHT_SELECT	If set the right channel of the mixer is added to the cellphone output signal.
2	LEFT_SELECT	If set the left channel of the mixer is added to the cellphone output signal.
3	CPO_MUTE	If set the CPOUT output is muted.
4	MIC_NOISE_GATE	If this is set and NOISE_GATE_ON (register 0x08h) is enabled, the MIC to CPO path will be gated if the signal is determined to be noise by the AGC (that is, if the signal is below the set noise threshold).

Note 24: The gain of cell phone output amplifier is 0 dB.

12.0 Status & Control Registers (Continued)

12.24 AUX_OUTPUT CONFIGURATION REGISTER

This register is used to control the differential auxiliary output. (Note 25)

TABLE 25. AUX_OUTPUT (0x13h)

Bits	Field	Description
0	CPI_SELECT	If set the cell phone input channel of the mixer is added to the aux output signal.
1	RIGHT_SELECT	If set the right channel of the mixer is added to the aux output signal.
2	LEFT_SELECT	If set the left channel of the mixer is added to the aux output signal.
3	AUX_MUTE	If set the aux output is muted.

Note 25: The gain of the auxiliary output amplifier is 0 dB. If a second (external) loudspeaker amplifier is to be used its gain should be set to 12 dB to match the onboard loudspeaker amplifier gain.

12.0 Status & Control Registers (Continued)

12.25 LS_OUTPUT CONFIGURATION REGISTER

This register is used to control the loudspeaker output. (Note 26)

TABLE 26. LS_OUTPUT (0x14h)

Bits	Field	Description
0	CPI_SELECT	If set the cell phone input channel of the mixer is added to the loudspeaker output signal.
1	RIGHT_SELECT	If set the right channel of the mixer is added to the loudspeaker output signal.
2	LEFT_SELECT	If set the left channel of the mixer is added to the loudspeaker output signal.
3	LS_MUTE	If set the loudspeaker output is muted.

Note 26: The gain of the loudspeaker output amplifier is 12 dB.

12.0 Status & Control Registers (Continued)

12.26 HP_OUTPUT CONFIGURATION REGISTER

This register is used to control the stereo headphone output. (Note 27)

TABLE 27. HP_OUTPUT (0x15h)

Bits	Field	Description
0	SIDETONE_SELECT	If set the sidetone channel of the mixer is added to both of the headphone output signals.
1	CPI_SELECT	If set the cell phone input channel of the mixer is added to both of the headphone output signals.
2	RIGHT_SELECT	If set the right channel of the mixer is added to the headphone output. If the STEREO bit (0x00h) is set, the right channel is added to the right headphone output signal only. If the STEREO bit (0x00h) is cleared, it is added to both the right and left headphone output signals.
3	LEFT_SELECT	If set the left channel of the mixer is added to the headphone output. If the STEREO bit (0x00h) is set, the left channel is added to the left headphone output signal only. If the STEREO bit (0x00h) is cleared, it is added to both the right and left headphone output signals.
4	HP_MUTE	If set the headphone output is muted.

Note 27: The gain of the headphone output amplifier is -6 dB for the cell phone input channel and sidetone channel of the mixer. When the STEREO bit (0x00h) is set, headphone output amplifier gain is -6 dB for the left and right channel. When the STEREO bit (0x00h) is cleared, the headphone output amplifier gain is -12 dB for the left and right channel (to allow enough headroom for adding them and routing them to both headphone amplifiers).

12.0 Status & Control Registers (Continued)

12.27 EP_OUTPUT CONFIGURATION REGISTER

This register is used to control the mono earpiece output. (Note 28)

TABLE 28. EP_OUTPUT (0x16h)

Bits	Field	Description
0	SIDETONE_SELECT	If set the sidetone channel of the mixer is added to the earpiece output signal.
1	CPI_SELECT	If set the cell phone input channel of the mixer is added to the earpiece output signal.
2	RIGHT_SELECT	If set the right channel of the mixer is added to the earpiece output signal.
3	LEFT_SELECT	If set the left channel of the mixer is added to the earpiece output signal.
4	EP_MUTE	If set the earpiece output is muted.

Note 28: The gain of the earpiece output amplifier is 6 dB.

12.0 Status & Control Registers (Continued)

12.28 DETECT CONFIGURATION REGISTER

This register is used to control the headset detection system.

TABLE 29. DETECT (0x17h)

Bits	Field	Description																																		
0	DET_INT	If set an IRQ is raised when a change is detected in the headset status. Clearing this bit will clear an IRQ that has been triggered by the headset detect.																																		
1	BTN_INT	If set an IRQ is raised when the headset button is pressed. Clearing this bit will clear an IRQ that has been triggered by a button event.																																		
2	TEMP_INT	If set an IRQ is raised during a temperature event. If cleared, the LM4935 will still automatically cycle the power amplifiers off if the internal temperature is too high. This bit should not be set whenever the loudspeaker amplifier is turned on. Clearing this bit will clear an IRQ that has been triggered by a temperature event.																																		
6:3	HS_DBNC_TIME	Sets the time used for debouncing the analog signals from the detection inputs used to sense the insertion/removal of a headset.																																		
		<table border="1"> <thead> <tr> <th>HS_DBNC_TIME</th> <th>Time (ms)</th> </tr> </thead> <tbody> <tr><td>0000₂</td><td>0</td></tr> <tr><td>0001₂</td><td>8</td></tr> <tr><td>0010₂</td><td>16</td></tr> <tr><td>0011₂</td><td>32</td></tr> <tr><td>0100₂</td><td>48</td></tr> <tr><td>0101₂</td><td>64</td></tr> <tr><td>0110₂</td><td>96</td></tr> <tr><td>0111₂</td><td>128</td></tr> <tr><td>1000₂</td><td>192</td></tr> <tr><td>1001₂</td><td>256</td></tr> <tr><td>1010₂</td><td>384</td></tr> <tr><td>1011₂</td><td>512</td></tr> <tr><td>1100₂</td><td>768</td></tr> <tr><td>1101₂</td><td>1024</td></tr> <tr><td>1110₂</td><td>1536</td></tr> <tr><td>1111₂</td><td>2048</td></tr> </tbody> </table>	HS_DBNC_TIME	Time (ms)	0000 ₂	0	0001 ₂	8	0010 ₂	16	0011 ₂	32	0100 ₂	48	0101 ₂	64	0110 ₂	96	0111 ₂	128	1000 ₂	192	1001 ₂	256	1010 ₂	384	1011 ₂	512	1100 ₂	768	1101 ₂	1024	1110 ₂	1536	1111 ₂	2048
HS_DBNC_TIME	Time (ms)																																			
0000 ₂	0																																			
0001 ₂	8																																			
0010 ₂	16																																			
0011 ₂	32																																			
0100 ₂	48																																			
0101 ₂	64																																			
0110 ₂	96																																			
0111 ₂	128																																			
1000 ₂	192																																			
1001 ₂	256																																			
1010 ₂	384																																			
1011 ₂	512																																			
1100 ₂	768																																			
1101 ₂	1024																																			
1110 ₂	1536																																			
1111 ₂	2048																																			

12.0 Status & Control Registers (Continued)

12.29 HEADSET DETECT OVERVIEW

The LM4935 has built in monitors to automatically detect headset insertion or removal. The detection scheme can differentiate between mono, stereo, mono-cellular and stereo-cellular headsets. Upon detection of headset insertion or removal, the LM4935 updates read-only bit 0 - headset absence/presence, bit 1 - mono/stereo headset and bit 2 - headset without mic / with mic, of the STATUS register (0x18h). Headset insertion/removal and headset type can also be detected in standby mode; this consumes no analog supply current when the headset is absent.

The LM4935 can be programmed to raise an interrupt (set the IRQ pin high) when headset insert/removal is sensed by setting bit 0 of DETECT (0x17h). When headset detection is enabled in active mode and a headset is not detected, the HPL_OUT and HPR_OUT amplifiers will be disabled (switched off for capless mode and muted for AC-coupled mode) and the EXT_BIAS pin will be disconnected from the MIC_BIAS amplifier, irrespective of control register settings.

The LM4935 also has the capability to detect button press, when a button is present on the headset microphone. Both parallel button-type (in parallel with the headset microphone, default value) and series button-type (in series with the headset microphone) can be detected; the button type used needs to be defined in bit 3 of MIC_2 (0x0Ch). Button press can also be detected in stand-by mode; this consumes 10 μ A of analog supply current for a series type push button and 100 μ A for a parallel type push button. Upon button press, the LM4935 updates bit 3 of STATUS (0x18h). In active OCL mode, with internal microphone selected (INT_EXT = 0; (reg 0x0Bh)), if a parallel pushbutton headset is inserted into the system, INT_EXT must be set high before BTN (bit 3 of STATUS (0x18h)) can be read. The LM4935 can also be programmed to raise an interrupt on the IRQ pin when button press is sensed by setting bit 1 of DETECT.

The LM4935 provides debounce programmability for headset and button detect. Debounce programmability can be used to reject glitches generated, and hence avoid false detection, while inserting/removing a headset or pressing a button.

Headset insert/removal debounce time is defined by HS_DBNC_TIME; bits 6:3 of DETECT (0x17h). Parallel button press debounce time is defined by BTN_DBNC_TIME; bits 5:4 of MIC_2 (0x0Ch).

Note that since the first effect of a series button press (microphone disconnected) is indistinguishable from headset removal, the debounce time for series button press is defined by HS_DBNC_TIME.

Headset and push button detection can be enabled by setting CHIP_MODE 0; bit 0 of BASIC (0x00h). For reliable headset / push button detection all following bits should be defined before enabling the headset detection system:

- 1) the OCL-bit (AC-Coupled / Capless headphone interface (bit 7 of BASIC (0x00h))
- 2) the headset insert/removal debounce settings (bit 6:3 of DETECT (0x17h))
- 3) the BTN_TYPE-bit (Parallel / Series push button type (bit 3 of MIC_2 (0x0Ch))
- 4) the parallel push button debounce settings (bit 5:4 of MIC_2 (0x0Ch))

Figure 8 shows terminal connections and jack configuration for various headsets. Care should be taken to avoid any DC path from the MIC_DET pin to ground when a headset is not inserted.

12.0 Status & Control Registers (Continued)

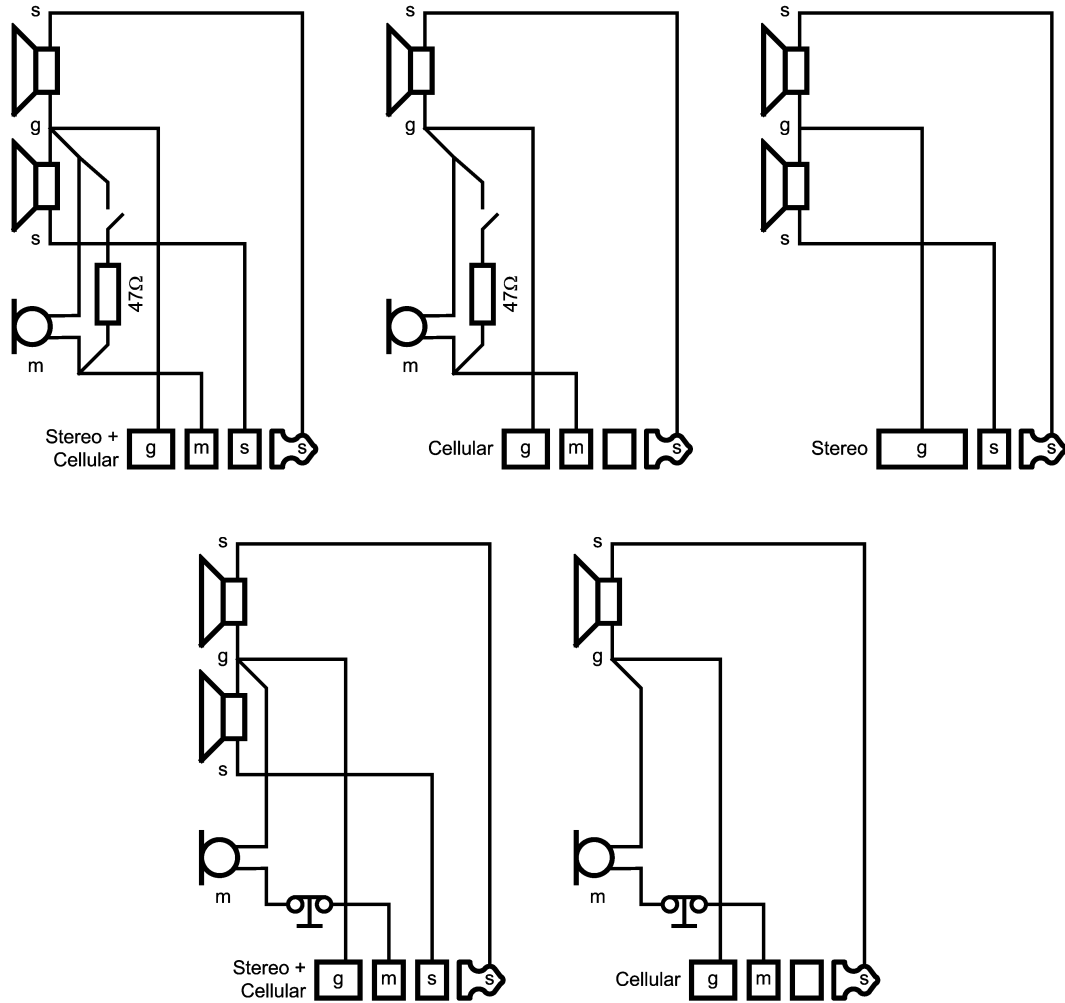

20134113

FIGURE 8. Headset Configurations Supported by the LM4935

The wiring of the headset jack to the LM4935 will depend on the intended mode of the headphone amplifier:

12.0 Status & Control Registers (Continued)

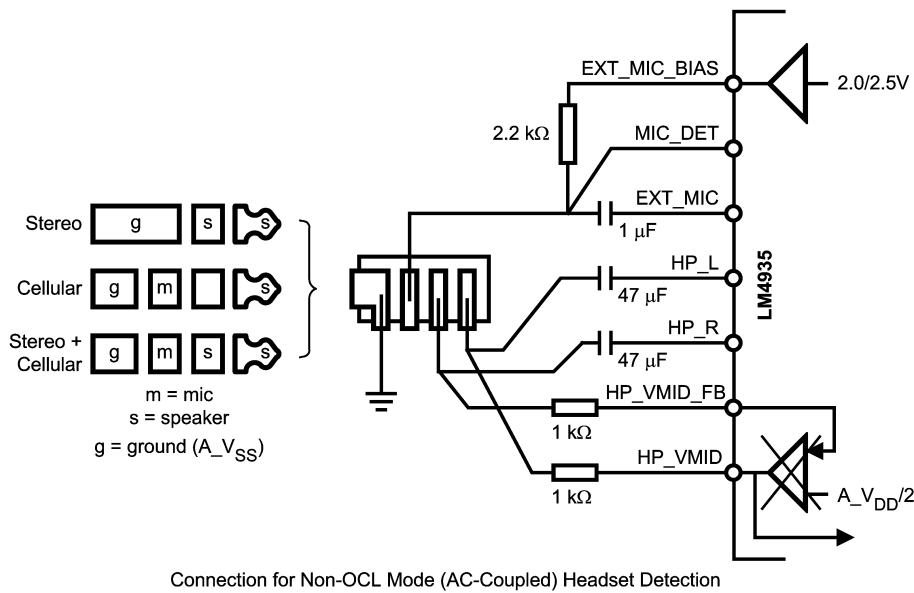
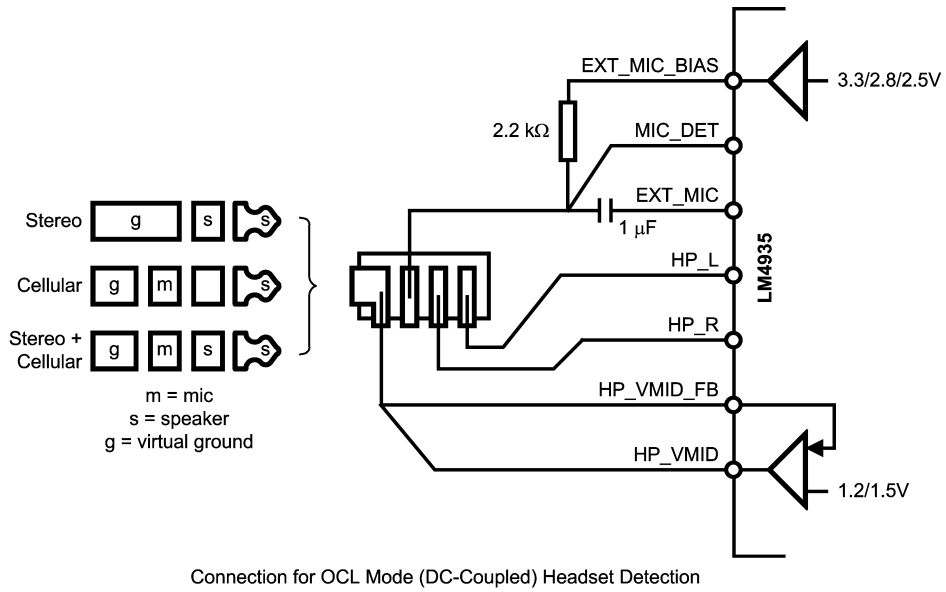

20134114

FIGURE 9. Connection of Headset Jack to LM4935 Depends on the Mode of the Headphone Amplifier.

12.0 Status & Control Registers (Continued)

12.30 STATUS REGISTER

This register is used to report the status of the device.

TABLE 30. STATUS (0x18h)

Bits	Field	Description
0	HEADSET	This field is high when headset presence is detected (only valid if the detection system is enabled). (Note 29)
1	STEREO_HEADSET	This field is high when a headset with stereo speakers is detected (only valid if the detection system is enabled). (Note 29)
2	MIC	This field is high when a headset with a microphone is detected (only valid if the detection system is enabled). (Note 29)
3	BTN	This field is high when the button on the headset is pressed (only valid if the detection system is enabled). IRQ is cleared when the button has been released and this register has been written to.
4	SAR TRIG 1	If this field is high then an event has happened on SAR trigger 1 (write to this register to clear IRQ).
5	SAR TRIG 2	If this field is high then an event has happened on SAR trigger 2 (write to this register to clear IRQ).
6	TEMP	If this field is high then a temperature event has occurred (write to this register to clear IRQ). This field will stay high even when the IRQ is cleared so long as the event occurs. This bit is only valid whenever the loudspeaker amplifier is turned off.
7	GPIN	When GPIO_SEL is set to a readable configuration a digital input on GPIO1 can be read back here.

Note 29: The detection IRQ is cleared when this register has been written to.

12.0 Status & Control Registers (Continued)

12.31 AUDIO INTERFACE CONFIGURATION REGISTER

This register is used to control the configuration of the audio data interfaces.

TABLE 31. AUDIO_IF (0x19h)

Bits	Field	Description						
1:0	AUDIO_IF_MODE	Selects the function of the 6 audio interface IOs.						
		AUDIO_IF_MODE	I ² S_ CLK pin	I ² S_ WS pin	I ² S_ SDI pin	I ² S_ SDO pin	GPIO_1 pin	GPIO_2 pin
		00 ₂	I ² S CLK	I ² S WS	I ² S SDI	I ² S SDO	GPIO 1	GPIO 2
		01 ₂	PCM CLK	PCM SYNC	-	PCM SDO	GPIO 1	GPIO 2
		10 ₂	PCM CLK	PCM SYNC	PCM SDI	PCM SDO	GPIO 1	GPIO 2
		11 ₂	I ² S CLK	I ² S WS	I ² S SDI	PCM SDO	PCM CLK	PCM SYNC
2	I2S_WS_MS	If set the I ² S_WS is produced by the LM4935 and the I ² S_WS pin will be an output.						
3	I2S_CLK_MS	If set the I ² S_CLK is produced by the LM4935 and the I ² S_CLK pin will be an output.						
4	PCM_SYNC_MS	If set the PCM_SYNC is produced by the LM4935 and the relevant pin will be an output.						
5	PCM_CLK_MS	If set the PCM_CLK is produced by the LM4935 and the relevant pin will be an output.						
7:6	I2S_SDO_DATA	The two ADCs on the LM4935 can both be read via the isochronous I2S interface. The most recent valid sample is output from the following source: (Please refer to the GPIO configuration register (0x1Ah) for more information on SAR_CH_SEL)						
		I2S_SDO_DATA		LEFT		RIGHT		
		00 ₂		AUDIO ADC		SAR_CH_SEL		
		01 ₂		SAR VSAR 1		SAR_CH_SEL		
		10 ₂		SAR VSAR 2		SAR_CH_SEL		
		11 ₂		A_V _{DD} /2		SAR_CH_SEL		

12.0 Status & Control Registers (Continued)

12.32 DIGITAL AUDIO DATA FORMATS

I2S master mode can only be used when the DAC is enabled unless the ADC_I2S_M bit is set. PCM Master mode can only be used when the ADC is enabled. If the PCM receiver interface is operated in slave mode the clock and sync should be enabled at the same time as the PCM receiver uses the first PCM frame to calculate the PCM interface format. This format can not be changed unless a soft reset is issued. It is strongly recommended that the LM4935 is operated in master mode as this eliminates the risk of sample rate mismatch between the data converters and the audio interfaces.

In master mode the I2S_CLK has a 60/40 duty cycle and a frequency of $50 \cdot f_s$. In slave mode the PCM and I2S receivers only record the 1st 16 and 18 bits of the serial words respectively. The I2S format is as follows:

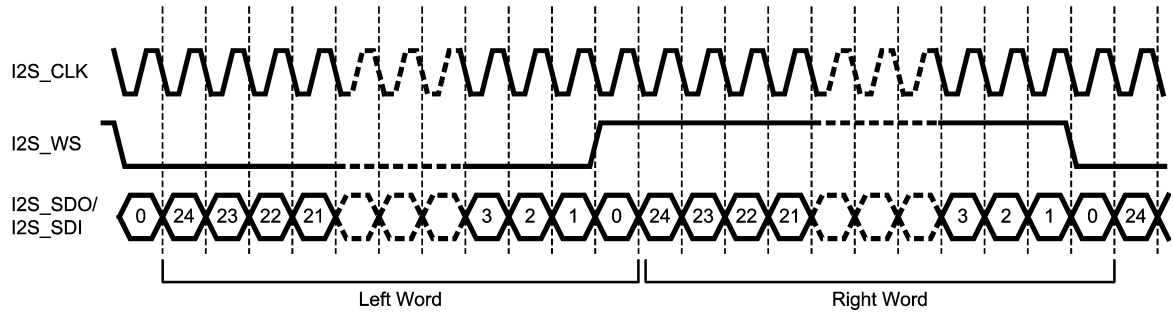

20134115

FIGURE 10. I²S Serial Data Format (Default Mode)

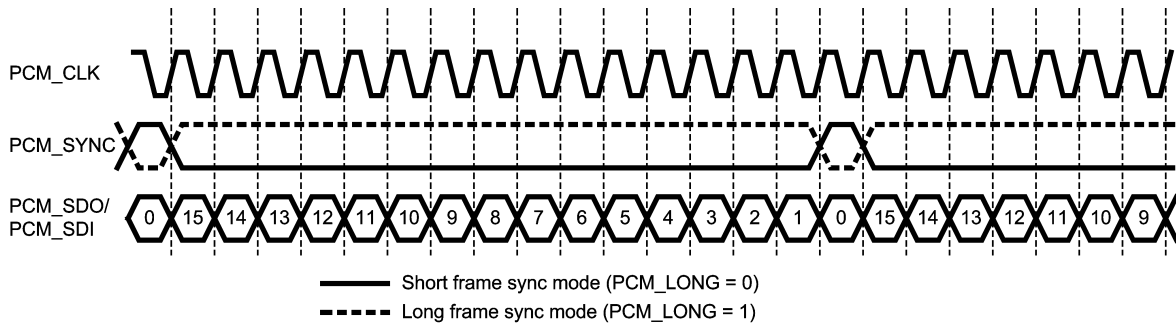

20134116

FIGURE 11. PCM Serial Data Format (16 bit Slave Example)

When SAR SDO data is passed to the I2S, it is left aligned (MSB aligned) to allow lower I2S resolutions to be used. If the DAC is driven from the PCM interface then the left channel of the DAC is used and the right channel is inactive.

12.0 Status & Control Registers (Continued)

12.33 GPIO CONFIGURATION REGISTER

This register is used to control the GPIO system.

TABLE 32. GPIO (0x1Ah)

Bits	Field	Description		
2:0	GPIO_SEL	This sets the function of the GPIOs when the Audio Interface is not using them.		
		GPIO_SEL	GPIO 1	GPIO 2
		000 ₂	0	0
		001 ₂	READABLE	SPI_SDO
		010 ₂	LS_AMP_ENABLE	SPI_SDO
		011 ₂	GPIO_DATA	SPI_SDO
		100 ₂	0	SPI_SDO
		101 ₂	READABLE	SAR_SDO
		110 ₂	LS_AMP_ENABLE	SAR_SDO
		111 ₂	GPIO_DATA	SAR_SDO
Setting GPIO_SEL = "010" with the GPIO_TEST_MODE bit (register 0X26h) set configures the GPIOs for digital mic operation. With this setting, GPIO1 will output VADC_CLK_OUT to provide a clock for the digital mic. GPIO2 will accept digital mic data. GPIO1's LS_AMP_ENABLE setting will be logic high whenever the loudspeaker amplifier is enabled. This is useful for enabling an external amplifier for stereo loudspeaker applications.				
4:3	SAR_CH_SEL	This field selects the SAR output channel for the 2nd (Right) I ² S channel or for SAR_SDO via GPIO2.		
		SAR_CH_SEL	Selected Channel	
		00 ₂	VSAR_1	
		01 ₂	VSAR_2	
		10 ₂	D_V _{DD} /2 or BB_V _{DD}	
11 ₂	A_V _{DD} /2			
5	I2S_MODE	If set the I2S operates in left justified mode (sometimes referred to as DSP mode). See example below. (Note 30)		
6	PCM_LONG	If set the PCM interface uses LONG frame sync which is essentially an inverted short frame sync.		
7	GPIO_DATA	If GPIO_SEL is set to GPIO_DATA then the content of this field is passed to GPIO1 as an output.		

Note 30: The left justified I²S mode is similar to normal I²S other than there is no delay between a change in WS to the MSB:

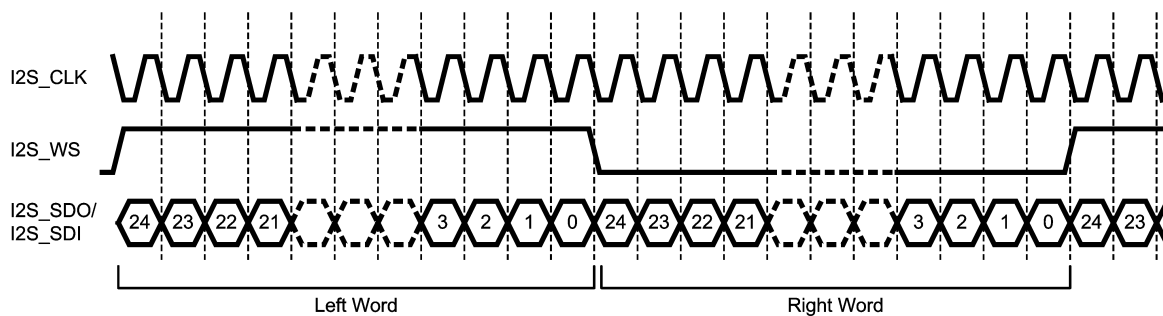

20134117

FIGURE 12. I²S Serial Data Format (Left Justified Mode)

12.0 Status & Control Registers (Continued)

12.34 SAR CHANNELS 0 & 1 CONFIGURATION REGISTER

This register is used to control channel 0 and 1 of the SAR system. (Note 31)

TABLE 33. SAR_SLOT01 (0x1Bh)

Bits	Field	Description	
2:0	SLOT_0_FS	Programs the sampling frequency of SAR channel 0:	
		SLOT_0_FS	Sample Rate @ 12.000 MHz (point A)
		000 ₂	13.888 kHz
		001 ₂	3.472 kHz
		010 ₂	0.868 kHz
		011 ₂	217 Hz
		100 ₂	54 Hz
		101 ₂	14 Hz
		110 ₂	4 Hz
111 ₂	1 Hz		
3	SLOT_0_ENB	If set then VSAR 1 is sampled into SAR slot 0 which also activates the SAR ADC.	
6:4	SLOT_1_FS	Programs the sampling frequency of SAR channel 1:	
		SLOT_1_FS	Sample Rate @ 12.000 MHz (point A)
		000 ₂	13.888 kHz
		001 ₂	3.472 kHz
		010 ₂	0.868 kHz
		011 ₂	217 Hz
		100 ₂	54 Hz
		101 ₂	14 Hz
		110 ₂	4 Hz
111 ₂	1 Hz		
7	SLOT_1_ENB	If set then VSAR 2 is sampled into SAR slot 1 which also activates the SAR ADC.	

Note 31: See the section **SAR Overview** for more details on this register.

12.0 Status & Control Registers (Continued)

12.35 SAR CHANNELS 2 & 3 CONFIGURATION REGISTER

This register is used to control channel 2 and 3 of the SAR system. (Note 31)

TABLE 34. SAR_SLOT23 (0x1Ch)

Bits	Field	Description	
2:0	SLOT_2_FS	Programs the sampling frequency of SAR channels 2 and 3:	
		SLOT_2_FS	Sample Rate @ 12.000 MHz (point A)
		000 ₂	13.888 kHz
		001 ₂	3.472 kHz
		010 ₂	0.868 kHz
		011 ₂	217 Hz
		100 ₂	54 Hz
		101 ₂	14 Hz
		110 ₂	4 Hz
111 ₂	1 Hz		
3	SLOT_2_ENB	If set then D_V _{DD} / 2 or BB_V _{DD} (depending on SLOT2_V _{BB}) is sampled into SAR slot 2 which also activates the SAR ADC.	
4	SLOT_3_ENB	If set then A_V _{DD} / 2 is sampled into SAR slot 3 which also activates the SAR ADC.	
5	SLOT_2_VBB	If set then BB_V _{DD} input is used as input to SAR slot 2 rather than the D_V _{DD} .	

12.0 Status & Control Registers (Continued)

12.36 SAR DATA 0 TO 3 REGISTERS

These registers are used to read the 8 MSBs from the 4 SAR channels.

TABLE 35. SAR_DATA_0 Register (0x1Dh)

Bits	Field	Description
7:0	SLOT_0_DATA	Latest slot 0 sample bits 11:4.

TABLE 36. SAR_DATA_1 Register (0x1Eh)

Bits	Field	Description
7:0	SLOT_1_DATA	Latest slot 1 sample bits 11:4.

TABLE 37. SAR_DATA_2 Register (0x1Fh)

Bits	Field	Description
7:0	SLOT_2_DATA	Latest slot 2 sample bits 11:4.

TABLE 38. SAR_DATA_3 Register (0x20h)

Bits	Field	Description
7:0	SLOT_3_DATA	Latest slot 3 sample bits 11:4.

12.0 Status & Control Registers (Continued)

12.37 SAR OVERVIEW

The SAR controller works via a scheduler that allocates time slots for each of the four channels. All four channels can operate up to the same maximum frequency. When the sampling frequency of a channel is to be reduced the time slot allocated to that channel is simply enabled less often. For example if one slot is to work at a quarter of the frequency of the others then only one in four of its allocated slot triggers the SAR to activate:

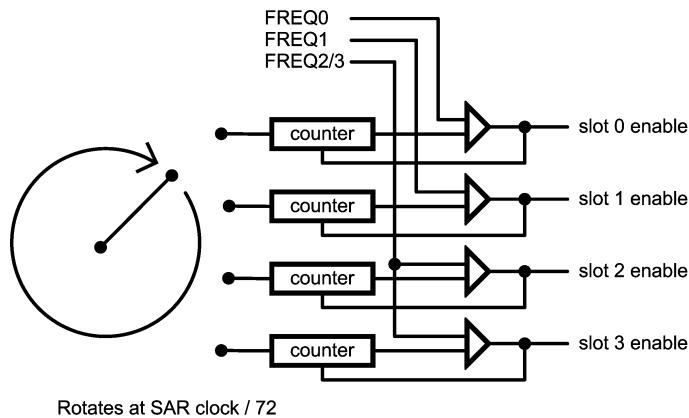

20134118

FIGURE 13. Internal SAR Control Signals to SAR Module

Each time slot is used to sample a single fixed input, slot 0 is used for VSAR 1, slot 1 for VSAR 2, slot 2 for either $D_{V_{DD}}$ or $BB_{V_{DD}}$ * and slot 3 for the $A_{V_{DD}}$. When a particular time slot is activated the correct mux, clock and enable controls to the ADC module are produced and the output sampled when ready. If the $D_{V_{DD}}$ or the $A_{V_{DD}}$ are being sampled then a voltage divider is used to half the input to below the full scale reference of 2.5V. As this results in a current path to ground it is only inserted while the ADC is settling to reduce power consumption.

Using this method, samples can be taken using as little power as possible while allowing sample rates as low as 1 Hz. The data can either be read directly or used to trigger interrupts when set voltages are passed. This reduces the baseband controllers software overhead and IO bandwidth, further reducing system power.

The full scale digital output from the SAR is equal to 2.5V. The $A_{V_{DD}}$ and $D_{V_{DD}}$ inputs are divided by two during sampling. The SAR ADC can be activated at any time, even while the chip is in shutdown mode (chip mode '00'). This allows the LM4935 to perform housekeeping duties such as voltage monitoring with minimal power consumption.

*Depending on SLOT_2_VBB in SAR_SLOT23 (0x1Ch).

12.0 Status & Control Registers (Continued)

Only the 8 MSBS [11:4] from the 12 bits of SAR output data can be read back using the I²C interface.

The SPI interface can be used to access all 12 bits of the SAR output data. In this case, GPIO2 should be set to SAR_SDO by setting GPIO_SEL in register (0x1Ah). The SAR channel selected by SAR_CH_SEL in the GPIO register is then output onto GPIO2 as follows:

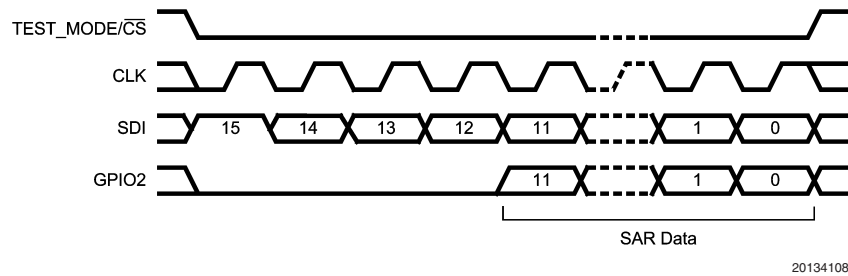

FIGURE 14. SPI SAR Read Transaction (GPIO2 set to SAR_SDO)

In applications where the 8 MSBS [11:4] from the SAR output data is enough resolution, GPIO2 should be set to SPI_SDO by setting GPIO_SEL in register (0x1Ah). The SAR data is then output on GPIO2 as follows:

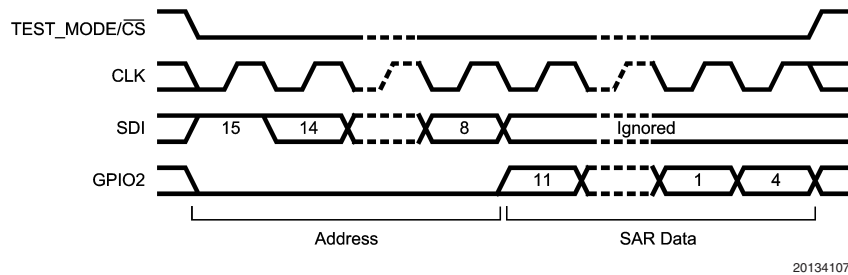

FIGURE 15. SPI SAR Read Transaction (GPIO2 set to SPI_SDO)

If the user performs a write to the GPIO register the changes will not take effect until the next SPI operation so SAR data can be read while the next channel is being selected. The SAR data is sampled at the start of the SPI transaction to ensure that the data is stable during the read operation.

All 12 bits of the SAR output data for up to 2 SAR channels can be read back simultaneously through the bi-directional I²S interface. This is accomplished by setting I2S_SDO_DATA (bit [7:6] of (0x19h)) to the desired SAR channel(s).

As mentioned previously in the **Digital Audio Data Formats** section, when SAR SDO is passed to the I²S bus, the SAR SDO's MSB is aligned with the MSB of I2S_SDO.

12.0 Status & Control Registers (Continued)

12.38 DC VOLUME CONFIGURATION REGISTER

This register is used to control the DC volume control system.

TABLE 39. DC_VOLUME (0x21h)

Bits	Field	Description	
0	DC_VOL_ENB	Enables the DC volume control system to use the voltage applied on the VSAR 1 pin to set the gain of the DC volume control. (Note 32)	
1	DC_VOL_EFFECT	Selects which volume is altered:	
		DC_VOL_EFFECT	Source
		0	AUX/DAC
1	CPI		
3:2	MAX_LEVEL	Programs the maximum level that can be applied by the system	
		MAX_LEVEL	LEVEL
		00 ₂	0 dB
		01 ₂	-3 dB
		10 ₂	-6 dB
11 ₂	-12 dB		

Note 32: The correlation between the voltage on VSAR1 to the attenuation on the AUX/DAC channel is as follows:

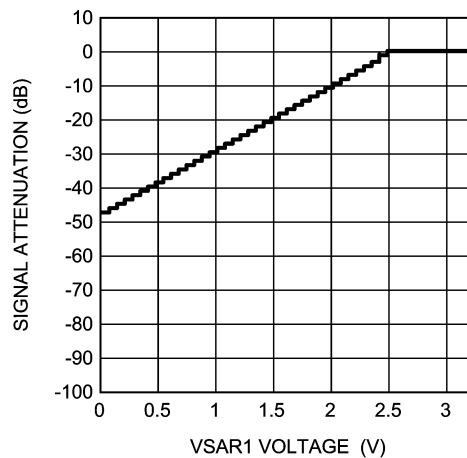

201341P4

FIGURE 16. DC Volume Transfer Function For AUX/DAC

12.0 Status & Control Registers (Continued)

12.39 SAR TRIGGER 1 CONFIGURATION REGISTER

This register is used to setup a voltage trigger on one of the SAR outputs.

TABLE 40. TRIG_1 (0x22h)

Bits	Field	Description	
0	TRIG_1_ENB	Enables the 1st SAR trigger interrupt, if cleared will clear the IRQ.	
1	TRIG_1_DIR	Selects the direction the voltage should be moving:	
		TRIG_1_DIR	Trigger if signal passes:
		0	Above Threshold
1	Below Threshold		
3:2	TRIG_1_SOURCE	Programs the channel used by the trigger.	
		TRIG_1_SOURCE	Source
		00 ₂	VSAR_1
		01 ₂	VSAR_2
		10 ₂	D_V _{DD} /2 or BB_V _{DD}
11 ₂	A_V _{DD} /2		
7:4	TRIG_1_LSB	Sets bits 3:0 of the threshold used by the trigger.	

12.0 Status & Control Registers (Continued)

12.40 SAR TRIGGER 1 MSBs CONFIGURATION REGISTER

This register is used to setup the threshold of a voltage trigger on one of the SAR outputs.

TABLE 41. TRIG_1_MSB (0x23h)

Bits	Field	Description
7:0	TRIG_1_MSB	Sets bits 11:4 of the threshold used by the trigger.

12.0 Status & Control Registers (Continued)

12.41 SAR TRIGGER 2 CONFIGURATION REGISTER

This register is used to setup a voltage trigger on one of the SAR outputs.

TABLE 42. TRIG_2 (0x24h)

Bits	Field	Description	
0	TRIG_2_ENB	Enables the 2nd SAR trigger interrupt, if cleared will clear the IRQ.	
1	TRIG_2_DIR	Selects the direction the voltage should be moving:	
		TRIG_2_DIR	Trigger if signal passes:
		0	Above Threshold
1	Below Threshold		
3:2	TRIG_2_SOURCE	Programs the channel used by the trigger	
		TRIG_2_SOURCE	Source
		00 ₂	VSAR_1
		01 ₂	VSAR_2
		10 ₂	D_V _{DD} /2 or BB_V _{DD}
11 ₂	A_V _{DD} /2		
7:4	TRIG_2_LSB	Sets bits 3:0 of the threshold used by the trigger.	

12.0 Status & Control Registers (Continued)

12.42 SAR TRIGGER 2 MSBs CONFIGURATION REGISTER

This register is used to setup the threshold of a voltage trigger on one of the SAR outputs.

TABLE 43. TRIG_2_MSB (0x25h)

Bits	Field	Description
7:0	TRIG_2_MSB	Sets bits 11:4 of the threshold used by the trigger.

12.0 Status & Control Registers (Continued)

12.43 DEBUG REGISTER

This register is used to set test modes within the device.

TABLE 44. DEBUG (0x26h)

Bits	Field	Description		
0	RSVD	Reserved		
1	RSVD	Reserved		
2	RSVD	Reserved		
3	SOFT_RESET	This field can be used to reset the chip without a power cycle.		
4	RSVD	Reserved		
5	RSVD	Reserved		
6	RSVD	Reserved		
7	GPIO_TEST_MODE	If set and GPIO_SEL = '010', then the GPIOs are configured to interface with the LMV1026 digital microphone as long as AUDIO_IF_MODE (0x19h) is not set to '11'.		
		GPIO_SEL	GPIO 1	GPIO 2
		000 ₂	RSVD	RSVD
		001 ₂	RSVD	RSVD
		010 ₂	VADC_CLOCK_OUT	DIG_MIC_IN
		011 ₂	RSVD	RSVD
		100 ₂	RSVD	RSVD
		101 ₂	RSVD	RSVD
		110 ₂	RSVD	RSVD
		111 ₂	RSVD	RSVD

13.0 Typical Performance Characteristics

(For all performance curves AV_{DD} refers to the voltage applied to the A_V_{DD} and LS_V_{DD} pins. DV_{DD} refers to the voltage applied to the D_V_{DD} and PLL_V_{DD} pins; $AV_{DD} = 3.3V$ and $DV_{DD} = 3.3V$ unless otherwise specified.)

Stereo DAC Frequency Response
 $f_s = 8kHz$

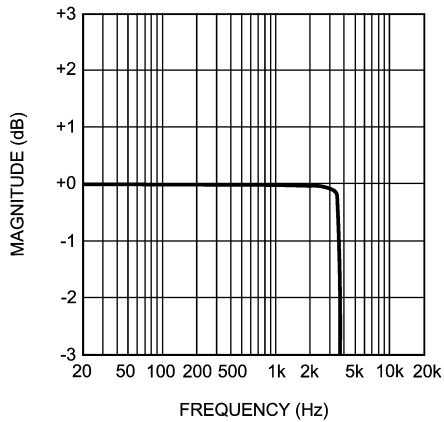

Stereo DAC Frequency Response Zoom
 $f_s = 8kHz$

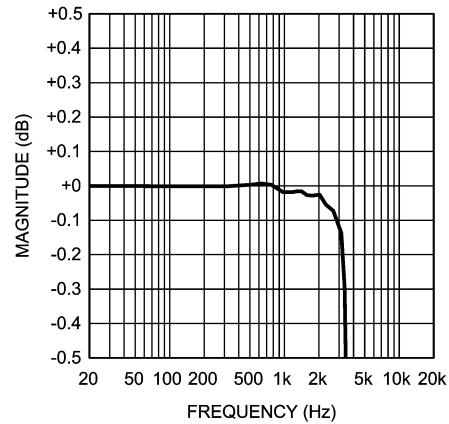

Stereo DAC Frequency Response
 $f_s = 16kHz$

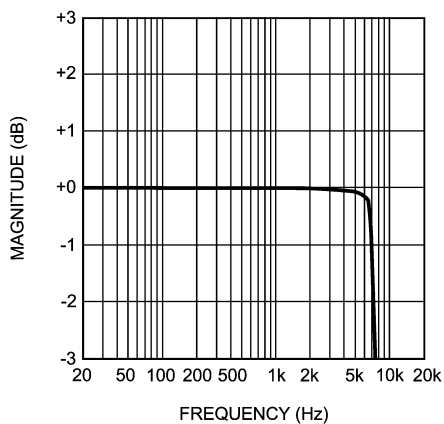

Stereo DAC Frequency Response Zoom
 $f_s = 16kHz$

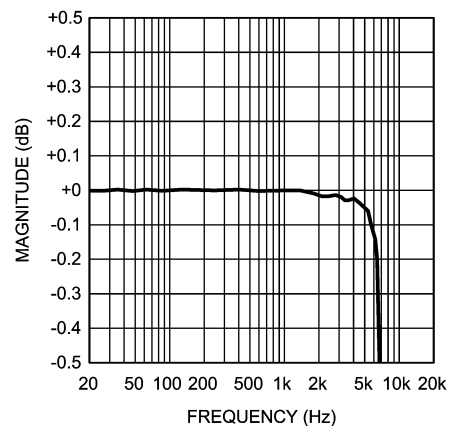

Stereo DAC Frequency Response
 $f_s = 24kHz$

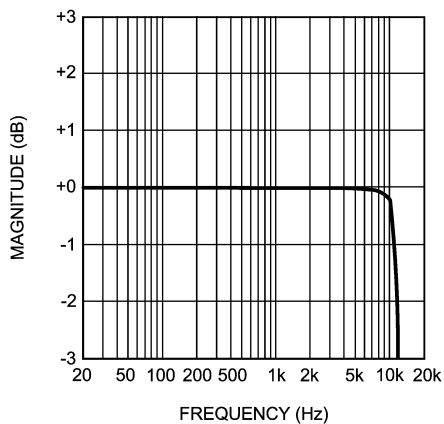

Stereo DAC Frequency Response Zoom
 $f_s = 24kHz$

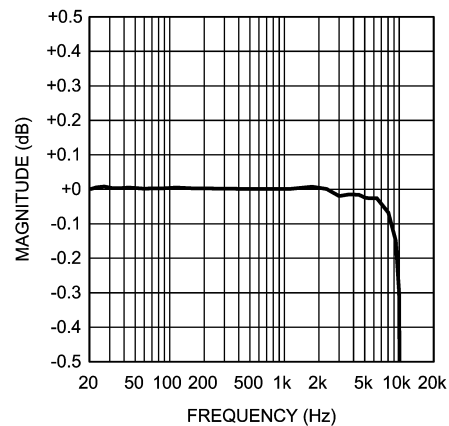

13.0 Typical Performance Characteristics (Continued)

Stereo DAC Frequency Response
 $f_s = 32\text{kHz}$

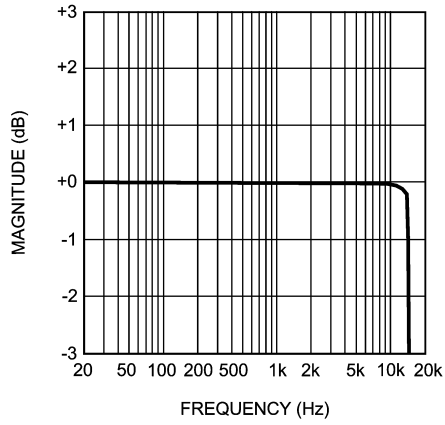

20134142

Stereo DAC Frequency Response Zoom
 $f_s = 32\text{kHz}$

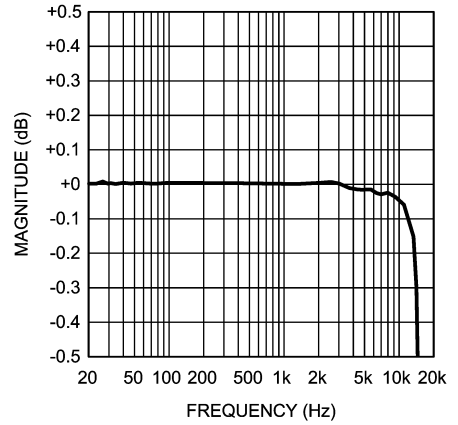

20134143

Stereo DAC Frequency Response
 $f_s = 48\text{kHz}$

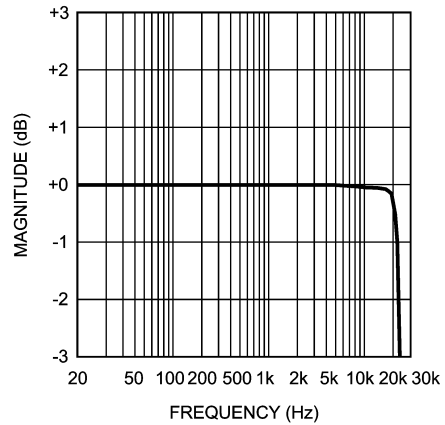

20134144

Stereo DAC Frequency Response Zoom
 $f_s = 48\text{kHz}$

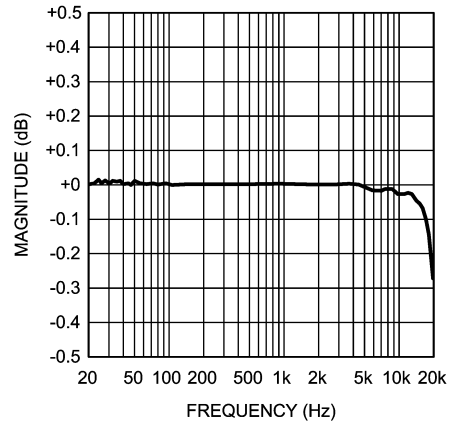

20134145

THD+N vs Stereo DAC Input Voltage
 (0dB DAC, AUXOUT)

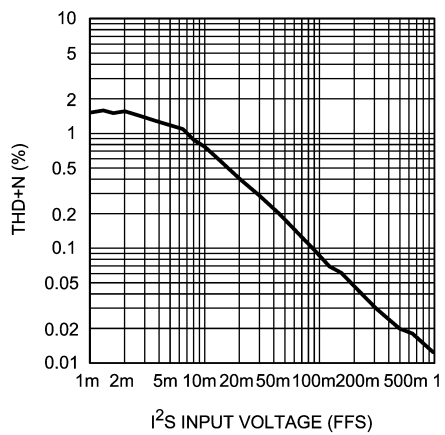

20134146

Stereo DAC Crosstalk
 (0dB DAC, HP SE)

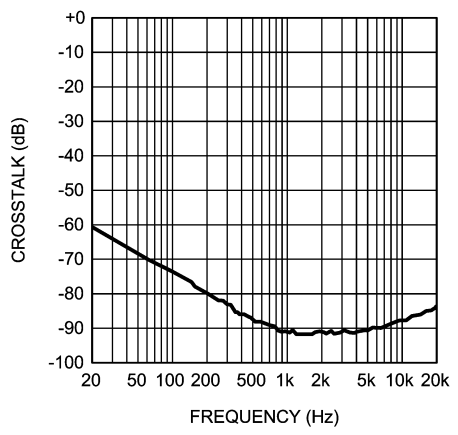

20134147

13.0 Typical Performance Characteristics (Continued)

MONO ADC Frequency Response
 $f_s = 8\text{kHz}$, 6dB MIC

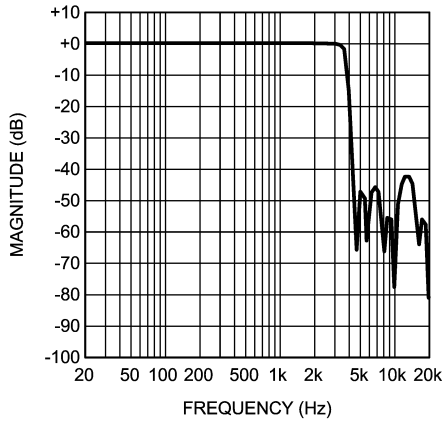

20134148

MONO ADC Frequency Response Zoom
 $f_s = 8\text{kHz}$, 6dB MIC

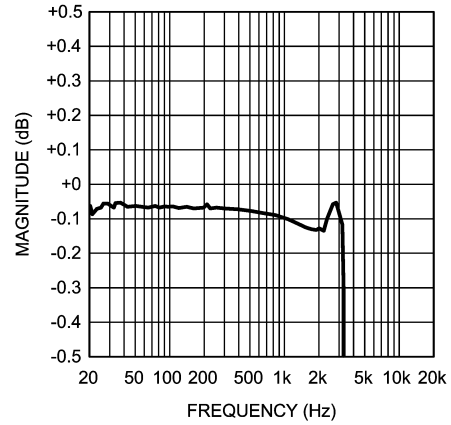

20134149

MONO ADC Frequency Response
 $f_s = 8\text{kHz}$, 36dB MIC

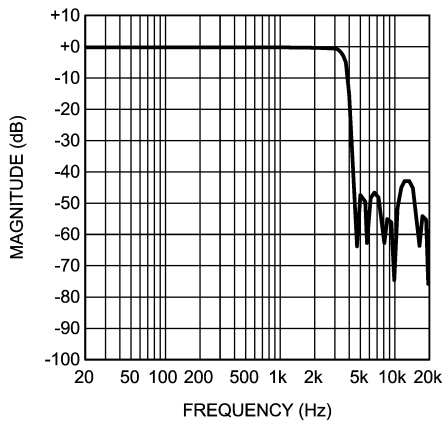

20134150

MONO ADC Frequency Response Zoom
 $f_s = 8\text{kHz}$, 36dB MIC

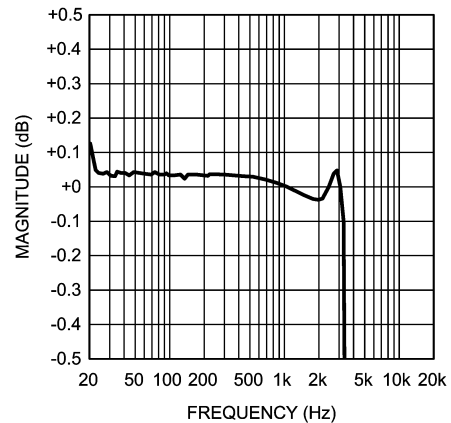

20134151

MONO ADC Frequency Response
 $f_s = 16\text{kHz}$, 6dB MIC

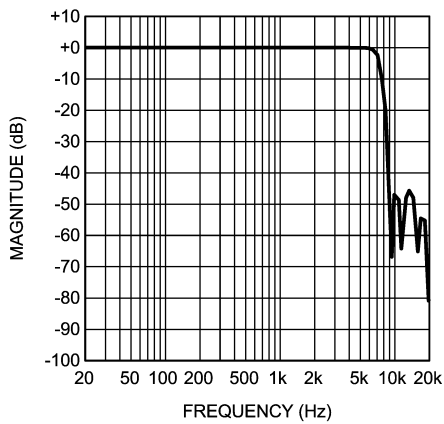

20134152

MONO ADC Frequency Response Zoom
 $f_s = 16\text{kHz}$, 6dB MIC

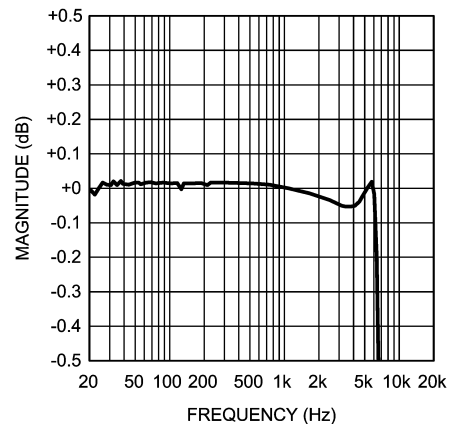

20134153

13.0 Typical Performance Characteristics (Continued)

MONO ADC Frequency Response
 $f_s = 16\text{kHz}$, 36dB MIC

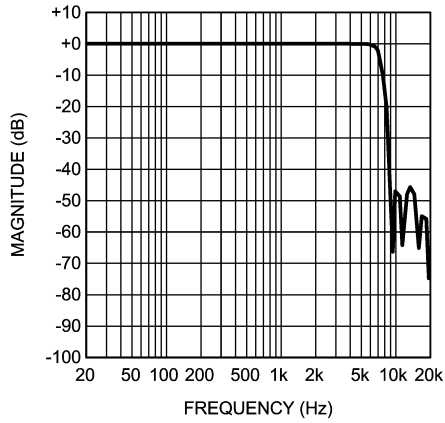

20134154

MONO ADC Frequency Response Zoom
 $f_s = 16\text{kHz}$, 36dB MIC

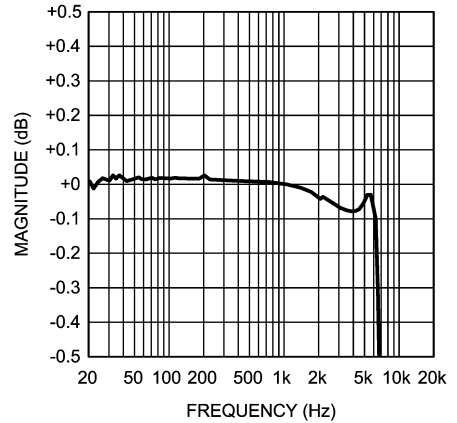

20134155

MONO ADC Frequency Response
 $f_s = 24\text{kHz}$, 6dB MIC

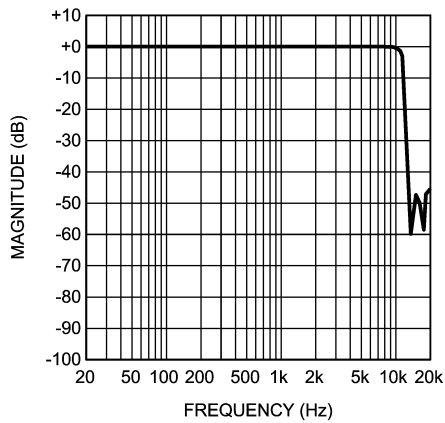

20134156

MONO ADC Frequency Response Zoom
 $f_s = 24\text{kHz}$, 6dB MIC

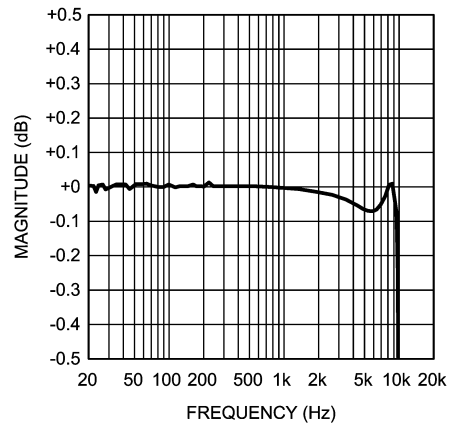

20134157

MONO ADC Frequency Response
 $f_s = 24\text{kHz}$, 36dB MIC

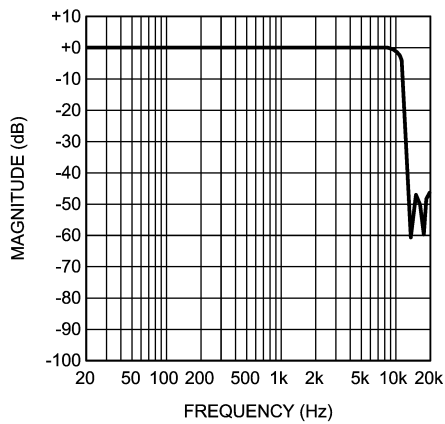

20134158

MONO ADC Frequency Response Zoom
 $f_s = 24\text{kHz}$, 36dB MIC

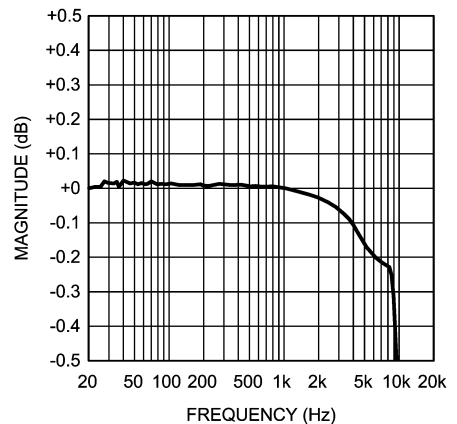

20134169

13.0 Typical Performance Characteristics (Continued)

MONO ADC Frequency Response
 $f_s = 32\text{kHz}$, 6dB MIC

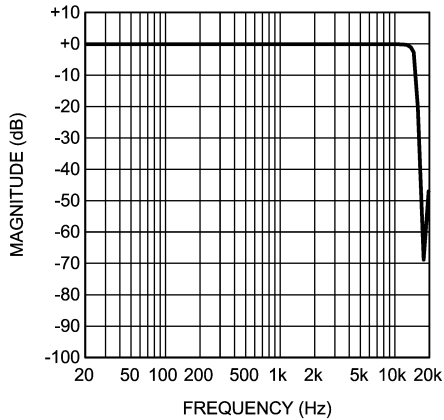

20134159

MONO ADC Frequency Response Zoom
 $f_s = 32\text{kHz}$, 6dB MIC

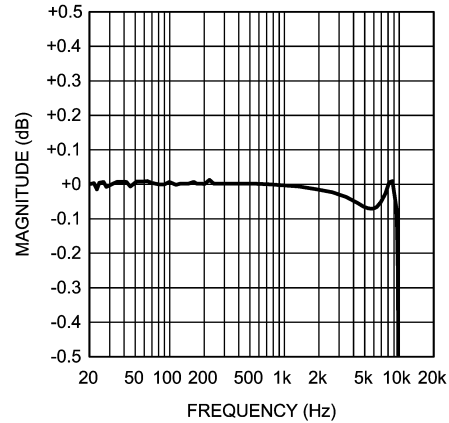

20134160

MONO ADC Frequency Response
 $f_s = 32\text{kHz}$, 36dB MIC

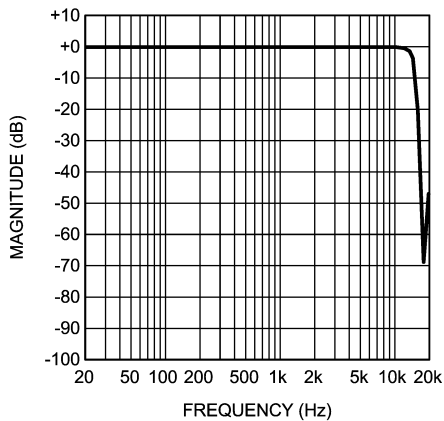

20134161

MONO ADC Frequency Response Zoom
 $f_s = 32\text{kHz}$, 36dB MIC

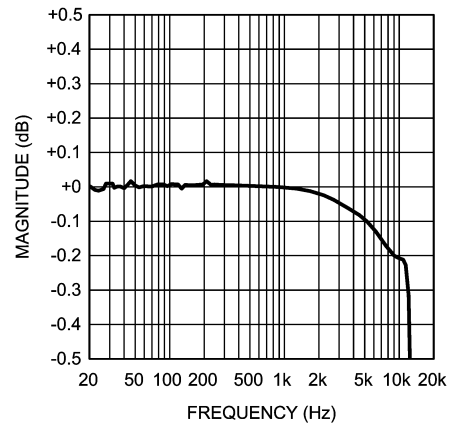

20134162

MONO ADC HPF Frequency Response
 $f_s = 8\text{kHz}$, 36dB MIC
 (from left to right: HPF_MODE '00', '10', '01')

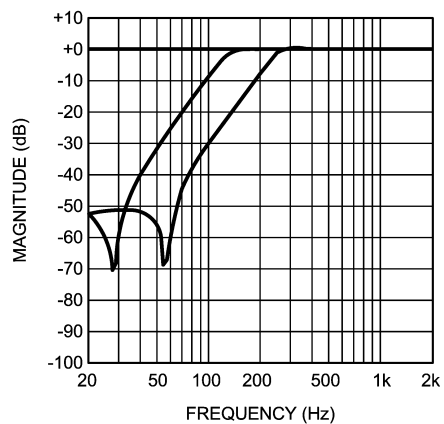

20134163

MONO ADC HPF Frequency Response
 $f_s = 16\text{kHz}$, 36dB MIC
 (from left to right: HPF_MODE '00', '10', '01')

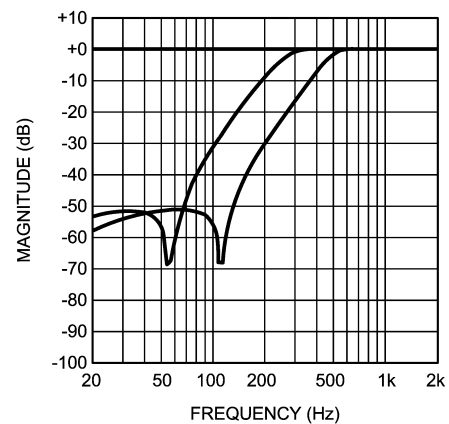

20134164

13.0 Typical Performance Characteristics (Continued)

MONO ADC HPF Frequency Response
 $f_s = 24\text{kHz}$, 36dB MIC
 (from left to right: HPF_MODE '00', '10', '01')

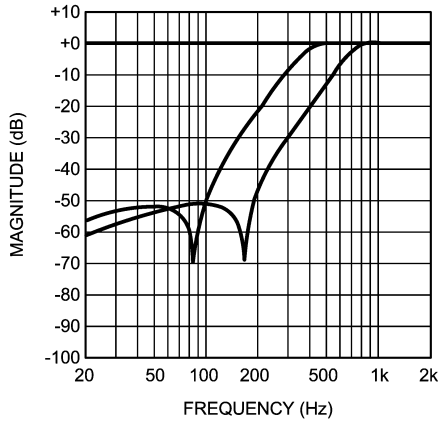

20134165

MONO ADC HPF Frequency Response
 $f_s = 32\text{kHz}$, 36dB MIC
 (from left to right: HPF_MODE '00', '10', '01')

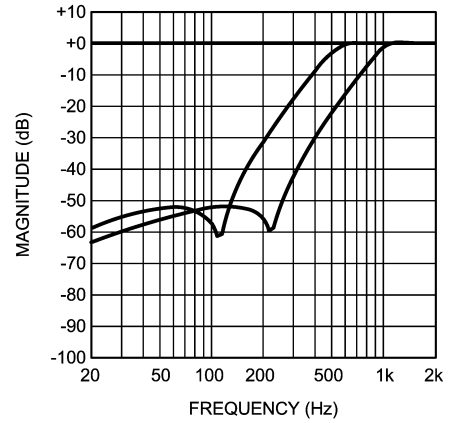

20134166

MONO ADC THD+N vs MIC Input Voltage
 $f_s = 8\text{kHz}$, 6dB MIC

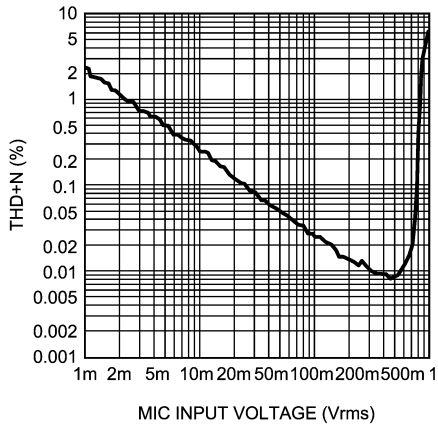

20134167

MONO ADC THD+N vs MIC Input Voltage
 $f_s = 8\text{kHz}$, 36dB MIC

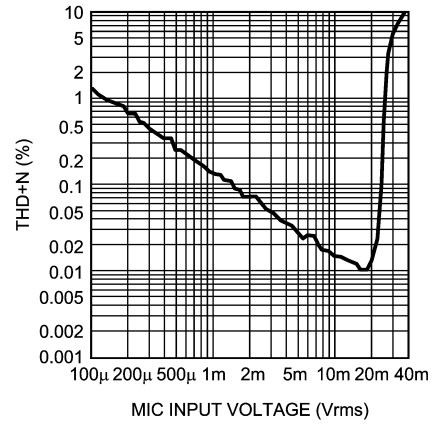

20134168

MONO ADC PSRR vs Frequency
 $AV_{DD} = 3.3\text{V}$, 6dB MIC

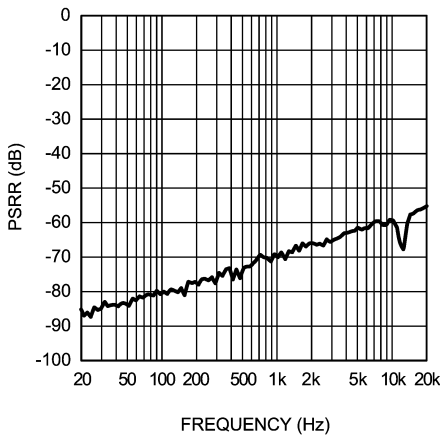

20134170

MONO ADC PSRR vs Frequency
 $AV_{DD} = 5\text{V}$, 6dB MIC

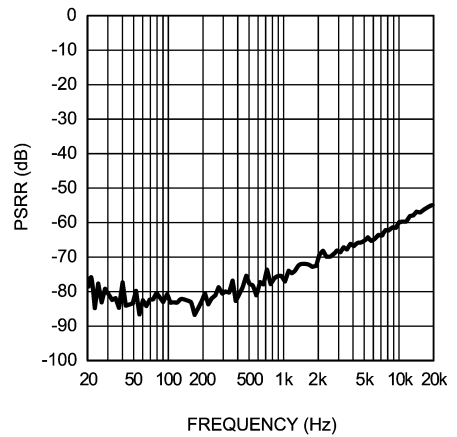

20134171

13.0 Typical Performance Characteristics (Continued)

MONO ADC PSRR vs Frequency
 $AV_{DD} = 3.3V, 36dB MIC$

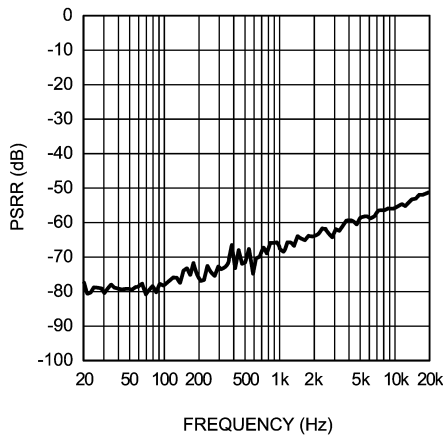

20134172

MONO ADC PSRR vs Frequency
 $AV_{DD} = 5V, 36dB MIC$

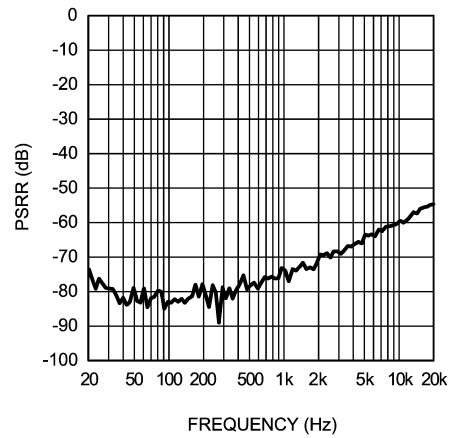

20134173

AUXOUT PSRR vs Frequency
 $AV_{DD} = 3.3V, 0dB AUX$
 (AUX inputs terminated)

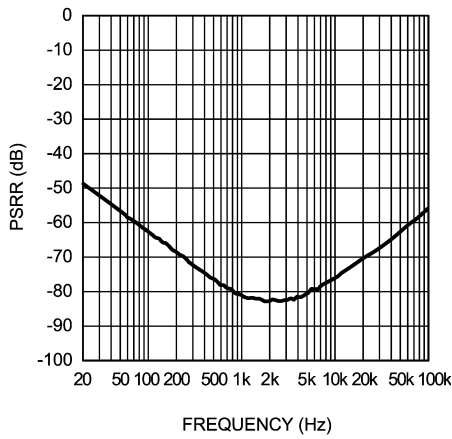

20134174

AUXOUT PSRR vs Frequency
 $AV_{DD} = 5V, 0dB AUX$
 (AUX inputs terminated)

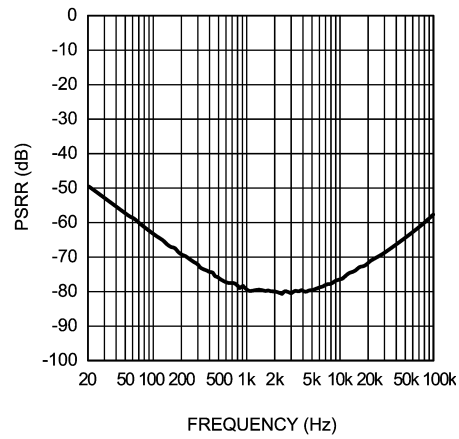

20134175

AUXOUT PSRR vs Frequency
 $AV_{DD} = 3.3V, 0dB CPI$
 (CPI inputs terminated)

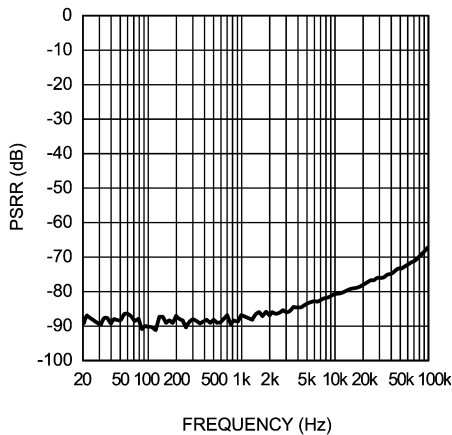

20134176

AUXOUT PSRR vs Frequency
 $AV_{DD} = 5V, 0dB CPI$
 (CPI inputs terminated)

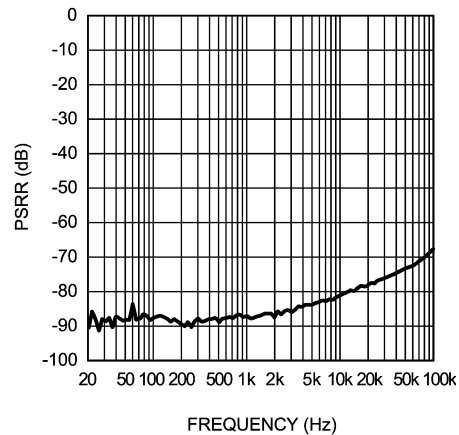

20134177

13.0 Typical Performance Characteristics (Continued)

AUXOUT PSRR vs Frequency
 $AV_{DD} = 3.3V$, 0dB DAC
 (DAC inputs selected)

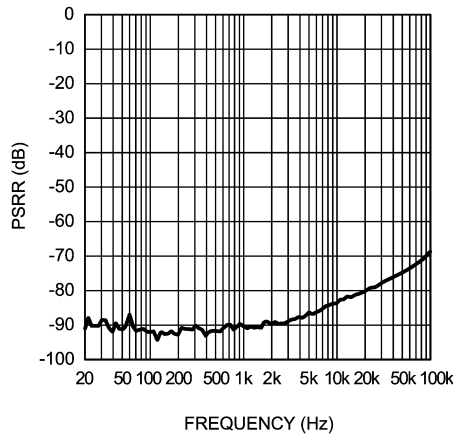

20134178

AUXOUT PSRR vs Frequency
 $AV_{DD} = 5V$, 0dB DAC
 (DAC inputs selected)

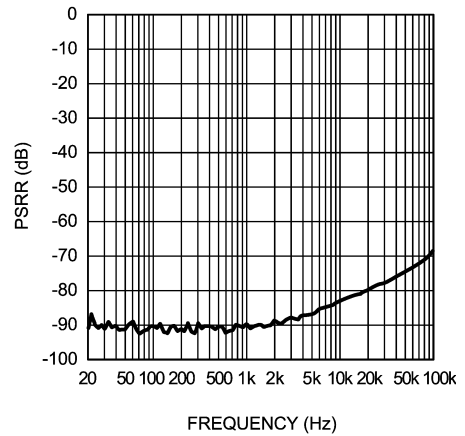

20134179

CPOUT PSRR vs Frequency
 $AV_{DD} = 3.3V$, 0dB AUX
 (AUX inputs terminated)

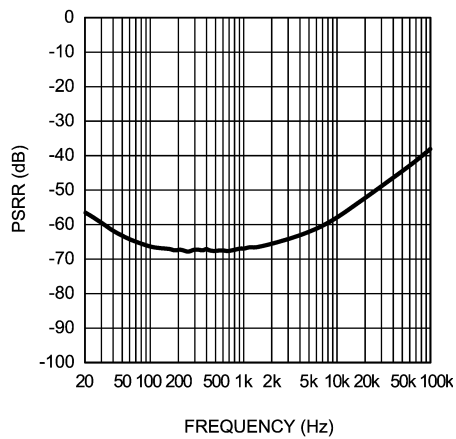

20134180

CPOUT PSRR vs Frequency
 $AV_{DD} = 5V$, 0dB AUX
 (AUX inputs terminated)

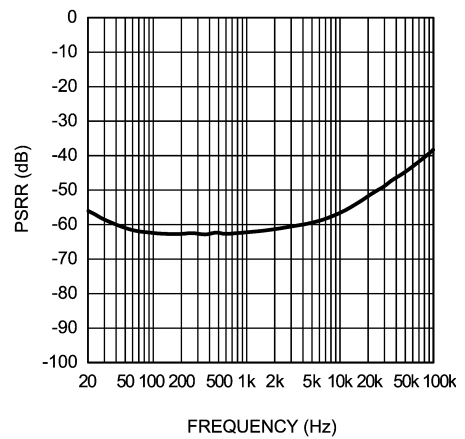

20134181

CPOUT PSRR vs Frequency
 $AV_{DD} = 3.3V$, 0dB DAC
 (DAC inputs selected)

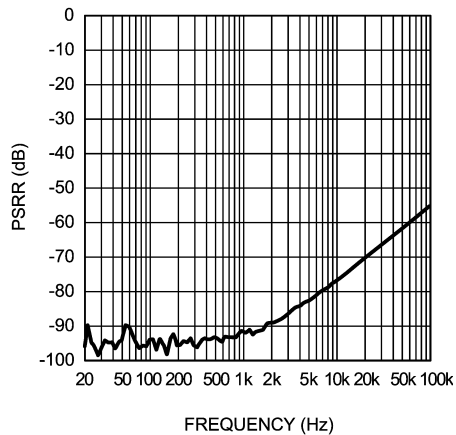

20134182

CPOUT PSRR vs Frequency
 $AV_{DD} = 5V$, 0dB DAC
 (DAC inputs selected)

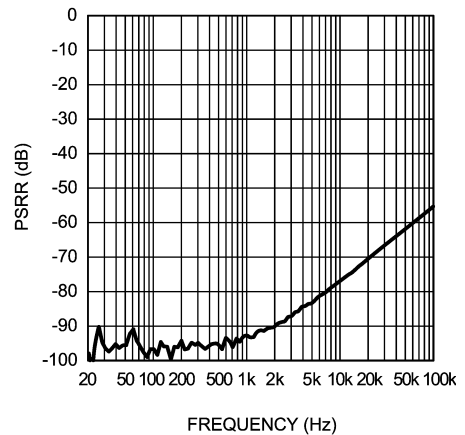

20134183

13.0 Typical Performance Characteristics (Continued)

CPOUT PSRR vs Frequency
 $AV_{DD} = 3.3V$, 36dB MIC
 (EXTMIC inputs terminated, AGC on)

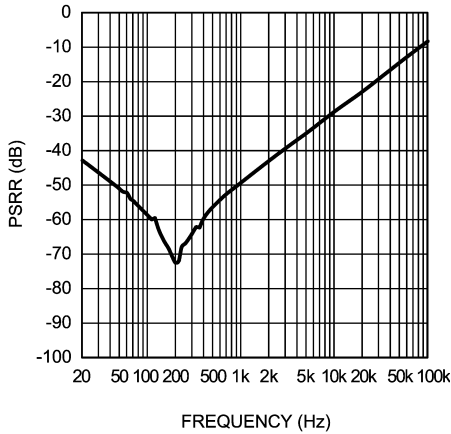

20134185

CPOUT PSRR vs Frequency
 $AV_{DD} = 5V$, 36dB MIC
 (EXTMIC inputs terminated, AGC on)

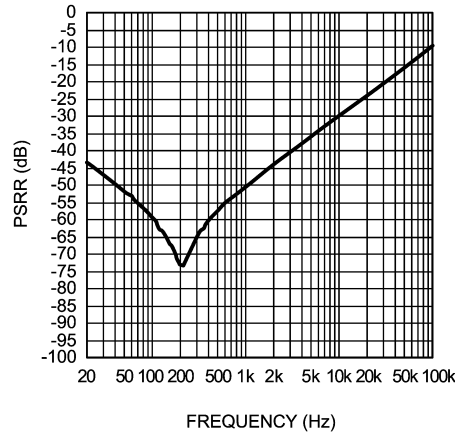

20134187

CPOUT PSRR vs Frequency
 $AV_{DD} = 3.3V$, 36dB MIC, MICBIAS = 2.0V
 (INTMIC DIFF inputs terminated, AGC off)

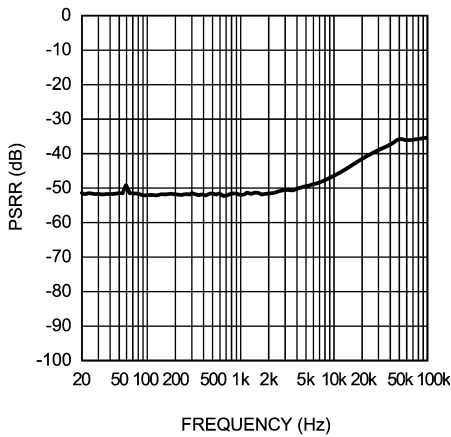

20134188

CPOUT PSRR vs Frequency
 $AV_{DD} = 3.3V$, 36dB MIC, MICBIAS = 2.0V
 (INTMIC DIFF inputs terminated, AGC on)

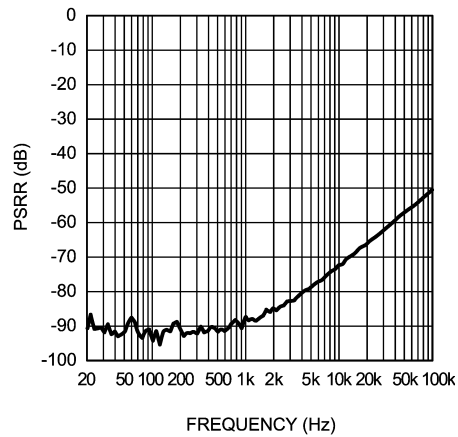

20134189

CPOUT PSRR vs Frequency
 $AV_{DD} = 3.3V$, 36dB MIC, MICBIAS = 2.5V
 (INTMIC DIFF inputs terminated, AGC off)

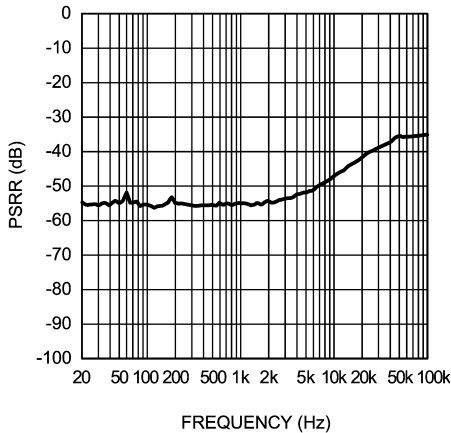

20134190

CPOUT PSRR vs Frequency
 $AV_{DD} = 3.3V$, 36dB MIC, MICBIAS = 2.5V
 (INTMIC DIFF inputs terminated, AGC on)

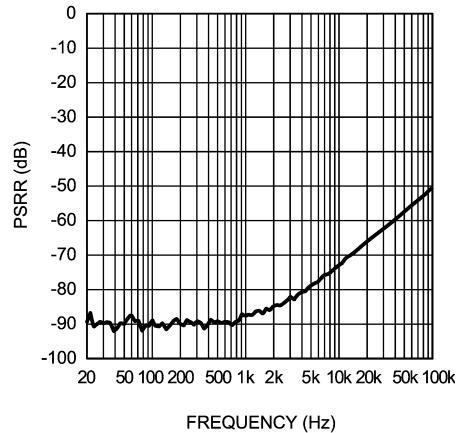

20134191

13.0 Typical Performance Characteristics (Continued)

CPOUT PSRR vs Frequency
 $AV_{DD} = 3.3V$, 36dB MIC, MICBIAS = 2.8V
 (INTMIC DIFF inputs terminated, AGC off)

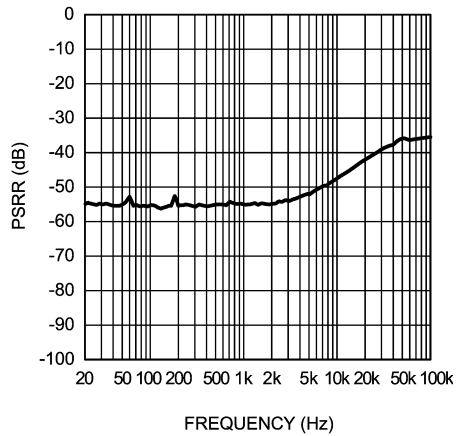

20134192

CPOUT PSRR vs Frequency
 $AV_{DD} = 3.3V$, 36dB MIC, MICBIAS = 2.8V
 (INTMIC DIFF inputs terminated, AGC on)

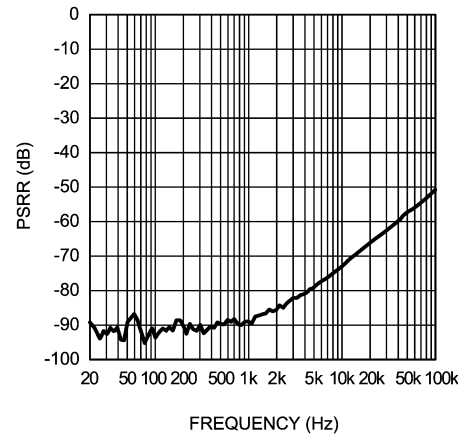

20134193

CPOUT PSRR vs Frequency
 $AV_{DD} = 5V$, 36dB MIC, MICBIAS = 2.0V
 (INTMIC DIFF inputs terminated, AGC off)

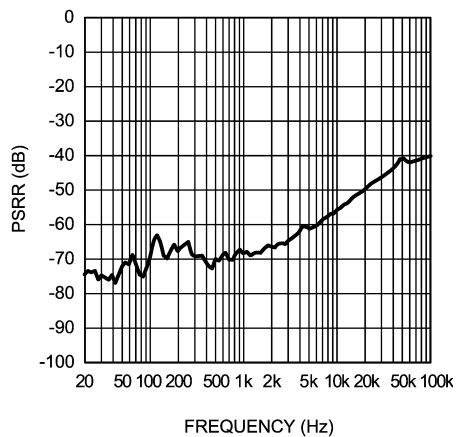

20134196

CPOUT PSRR vs Frequency
 $AV_{DD} = 5V$, 36dB MIC, MICBIAS = 2.0V
 (INTMIC DIFF inputs terminated, AGC on)

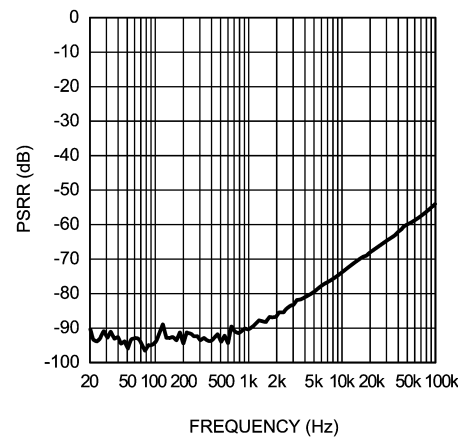

20134197

CPOUT PSRR vs Frequency
 $AV_{DD} = 5V$, 36dB MIC, MICBIAS = 2.5V
 (INTMIC DIFF inputs terminated, AGC off)

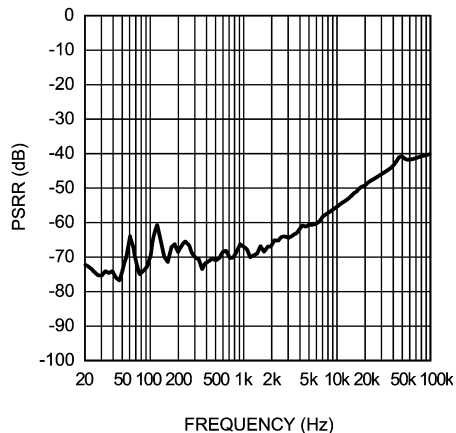

20134198

CPOUT PSRR vs Frequency
 $AV_{DD} = 5V$, 36dB MIC, MICBIAS = 2.5V
 (INTMIC DIFF inputs terminated, AGC on)

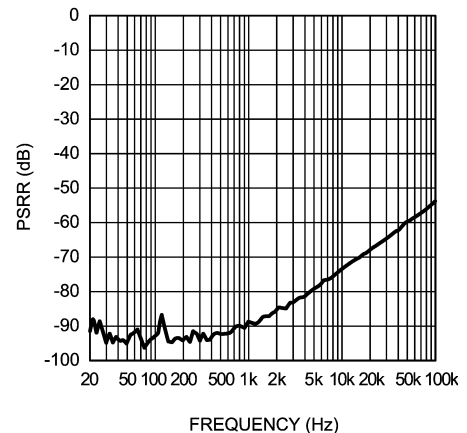

20134199

13.0 Typical Performance Characteristics (Continued)

CPOUT PSRR vs Frequency
 $AV_{DD} = 5V$, 36dB MIC, MICBIAS = 2.8V
 (INTMIC DIFF inputs terminated, AGC off)

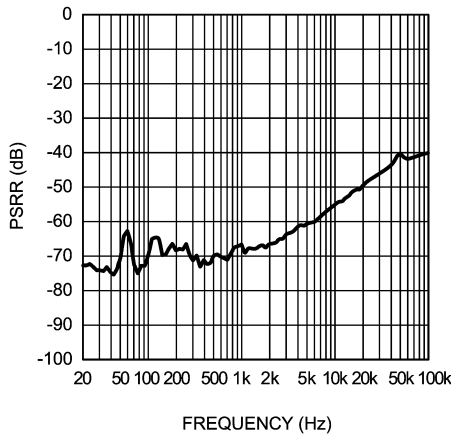

201341A0

CPOUT PSRR vs Frequency
 $AV_{DD} = 5V$, 36dB MIC, MICBIAS = 2.8V
 (INTMIC DIFF inputs terminated, AGC on)

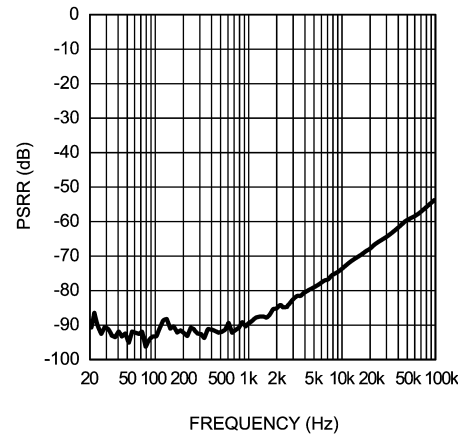

201341A1

CPOUT PSRR vs Frequency
 $AV_{DD} = 5V$, 36dB MIC, MICBIAS = 3.3V
 (INTMIC DIFF inputs terminated, AGC off)

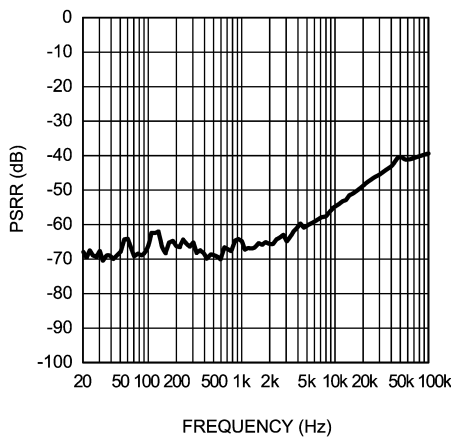

201341A2

CPOUT PSRR vs Frequency
 $AV_{DD} = 5V$, 36dB MIC, MICBIAS = 3.3V
 (INTMIC DIFF inputs terminated, AGC on)

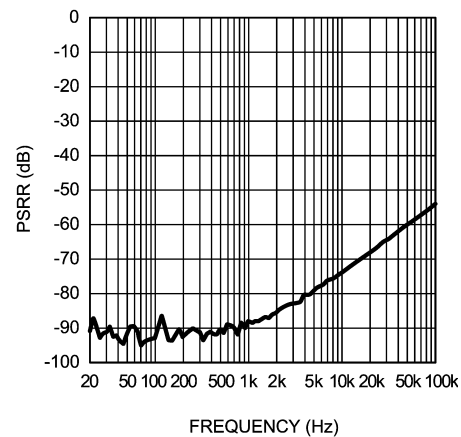

201341A3

CPOUT PSRR vs Frequency
 $AV_{DD} = 3.3V$, 36dB MIC
 (INTMIC SE input terminated, AGC on)

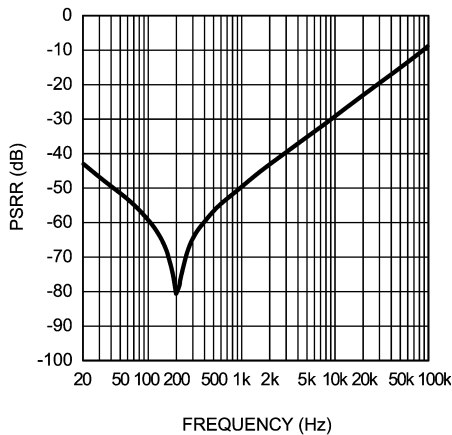

201341A5

CPOUT PSRR vs Frequency
 $AV_{DD} = 5V$, 36dB MIC
 (INTMIC SE input terminated, AGC on)

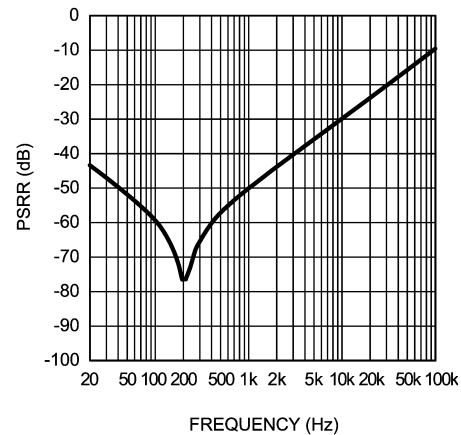

201341A7

13.0 Typical Performance Characteristics (Continued)

Earpiece PSRR vs Frequency
 $AV_{DD} = 3.3V$, 0dB AUX
 (AUX inputs terminated)

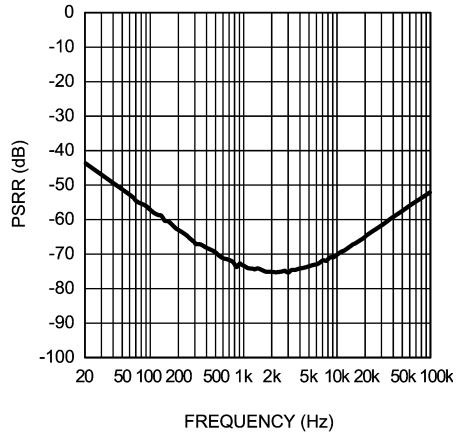

201341A8

Earpiece PSRR vs Frequency
 $AV_{DD} = 5V$, 0dB AUX
 (AUX inputs terminated)

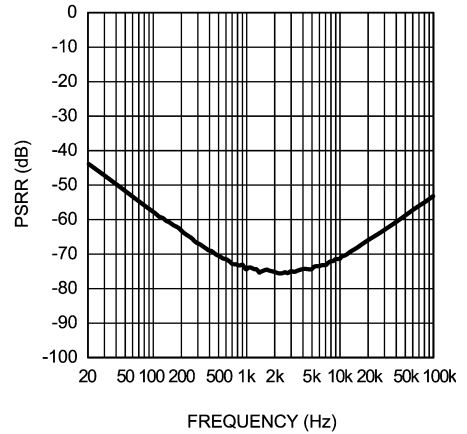

201341A9

Earpiece PSRR vs Frequency
 $AV_{DD} = 3.3V$, 0dB CPI
 (CPI input terminated)

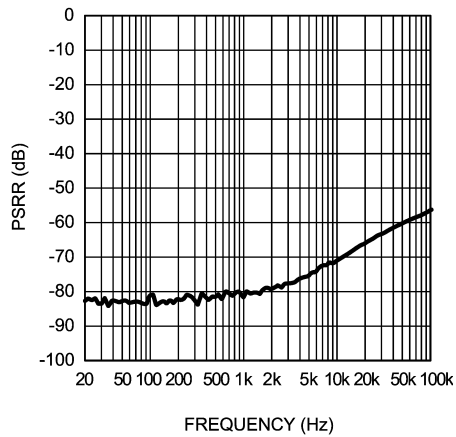

201341B0

Earpiece PSRR vs Frequency
 $AV_{DD} = 5V$, 0dB CPI
 (CPI input terminated)

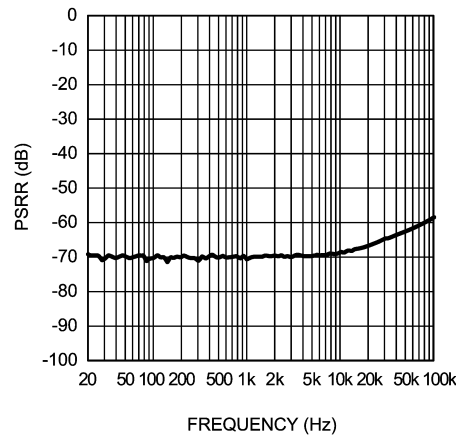

201341B1

Earpiece PSRR vs Frequency
 $AV_{DD} = 3.3V$, 0dB DAC
 (DAC input selected)

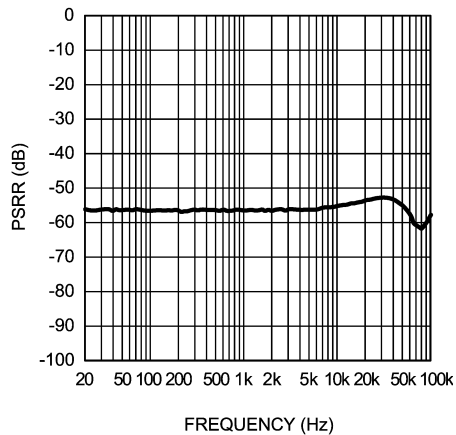

201341B2

Earpiece PSRR vs Frequency
 $AV_{DD} = 5V$, 0dB DAC
 (DAC input selected)

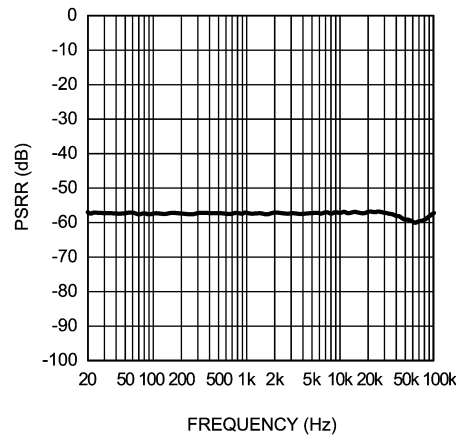

201341B3

13.0 Typical Performance Characteristics (Continued)

Headphone PSRR vs Frequency
 $AV_{DD} = 3.3V$, 0dB AUX, OCL 1.2V
 (AUX inputs terminated)

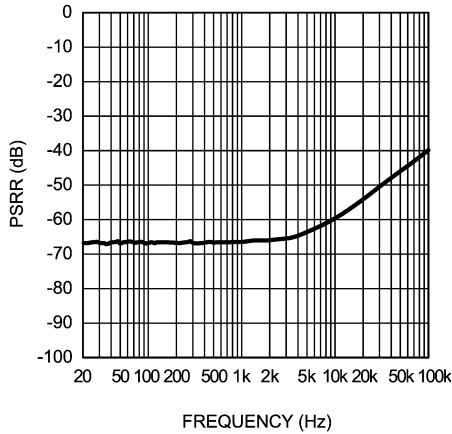

201341B4

Headphone PSRR vs Frequency
 $AV_{DD} = 5V$, 0dB AUX, OCL 1.2V
 (AUX inputs terminated)

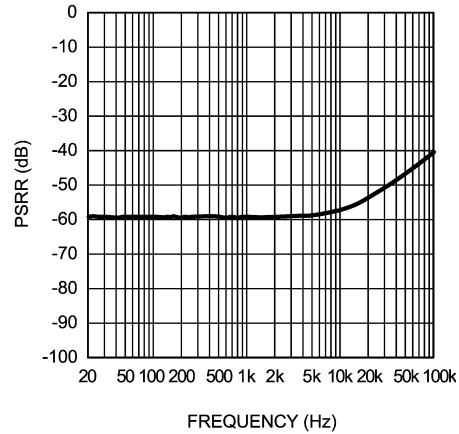

201341B5

Headphone PSRR vs Frequency
 $AV_{DD} = 3.3V$, 0dB CPI, OCL 1.2V
 (CPI input terminated)

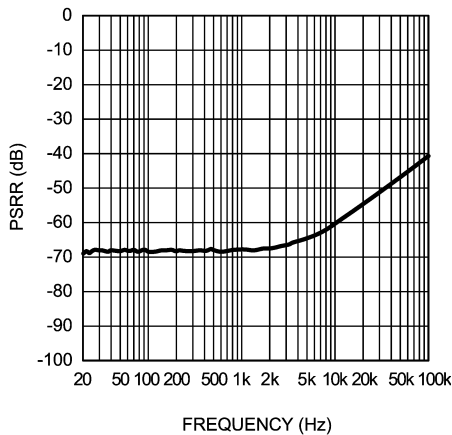

201341B6

Headphone PSRR vs Frequency
 $AV_{DD} = 5V$, 0dB CPI, OCL 1.2V
 (CPI input terminated)

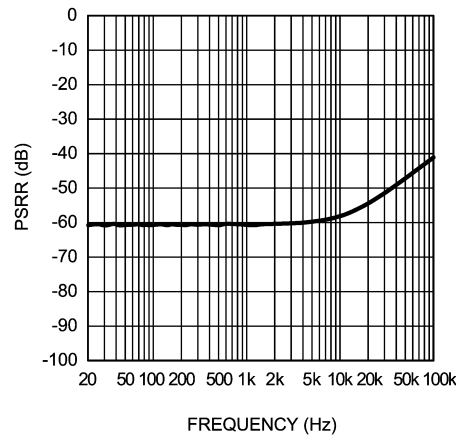

201341B7

Headphone PSRR vs Frequency
 $AV_{DD} = 3.3V$, 0dB ADC, OCL 1.2V
 (DAC input selected)

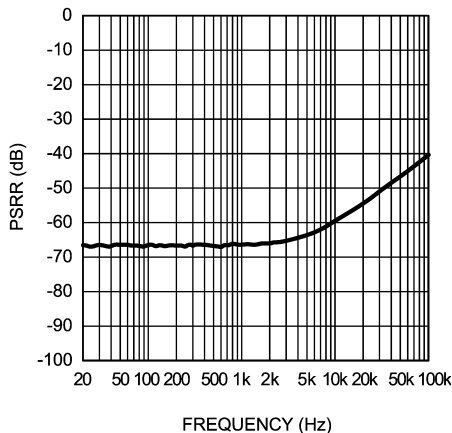

201341B8

Headphone PSRR vs Frequency
 $AV_{DD} = 5V$, 0dB ADC, OCL 1.2V
 (DAC input selected)

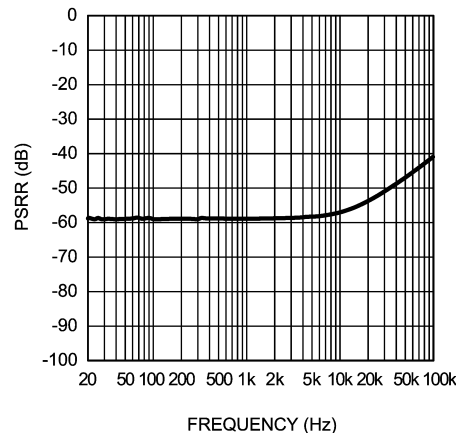

201341B9

13.0 Typical Performance Characteristics (Continued)

Headphone PSRR vs Frequency
 $AV_{DD} = 3.3V$, 0dB AUX, OCL 1.5V
 (AUX inputs terminated)

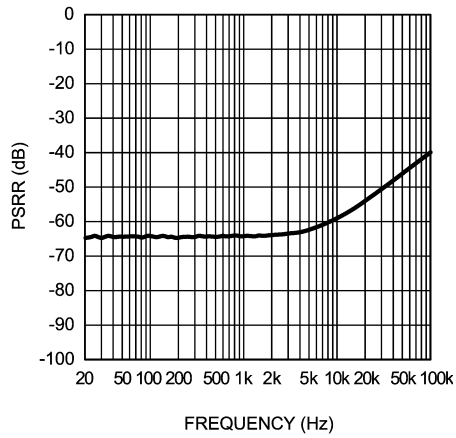

201341C0

Headphone PSRR vs Frequency
 $AV_{DD} = 5V$, 0dB AUX, OCL 1.5V
 (AUX inputs terminated)

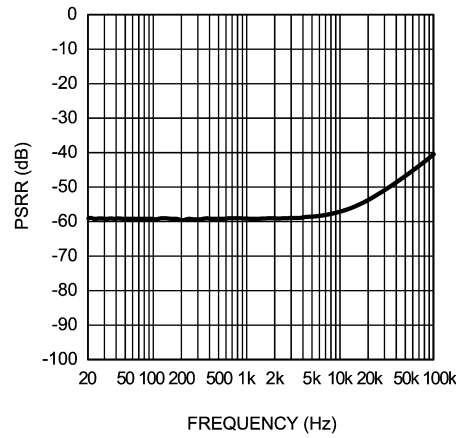

201341C1

Headphone PSRR vs Frequency
 $AV_{DD} = 3.3V$, 0dB CPI, OCL 1.5V
 (CPI input terminated)

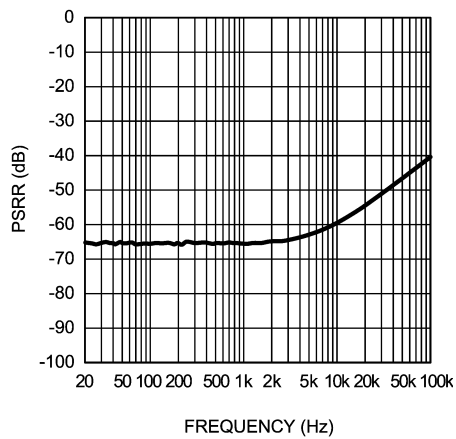

201341C2

Headphone PSRR vs Frequency
 $AV_{DD} = 5V$, 0dB CPI, OCL 1.5V
 (CPI input terminated)

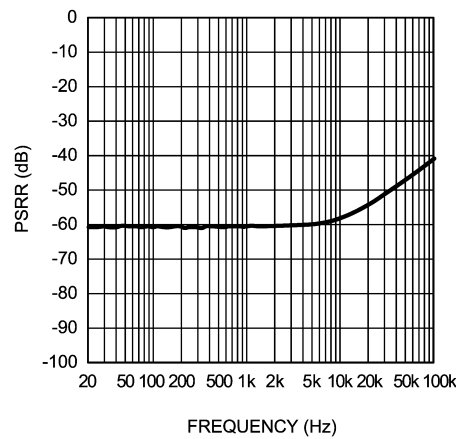

201341C3

Headphone PSRR vs Frequency
 $AV_{DD} = 3.3V$, 0dB DAC, OCL 1.5V
 (DAC input selected)

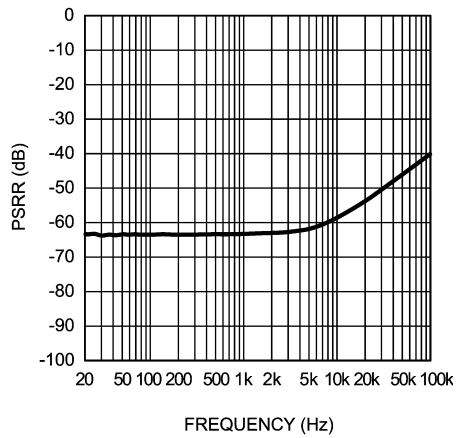

201341C4

Headphone PSRR vs Frequency
 $AV_{DD} = 5V$, 0dB DAC, OCL 1.5V
 (DAC input selected)

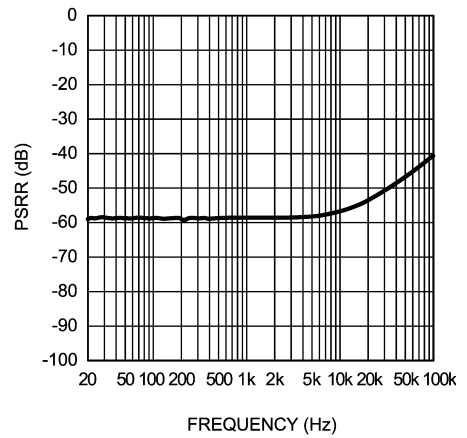

201341C5

13.0 Typical Performance Characteristics (Continued)

Headphone PSRR vs Frequency
 $AV_{DD} = 3.3V$, 0dB AUX, SE
 (AUX inputs terminated)

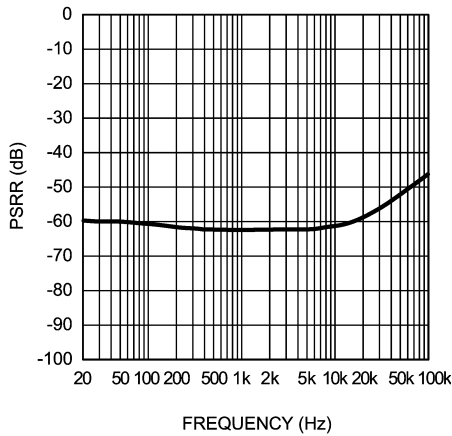

201341C6

Headphone PSRR vs Frequency
 $AV_{DD} = 5V$, 0dB AUX, SE
 (AUX inputs terminated)

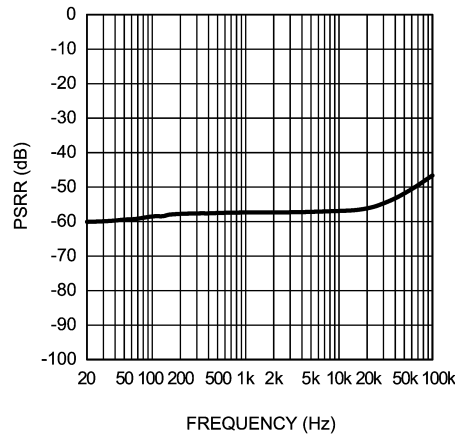

201341C7

Headphone PSRR vs Frequency
 $AV_{DD} = 3.3V$, 0dB CPI, SE
 (CPI input terminated)

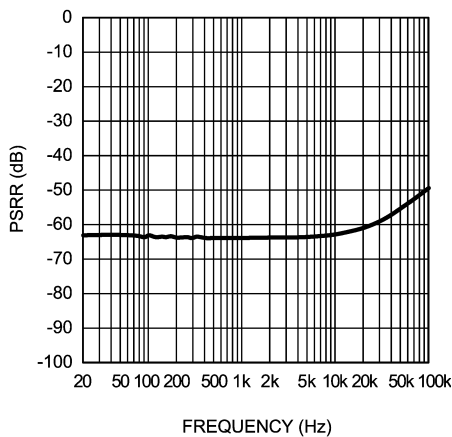

201341C8

Headphone PSRR vs Frequency
 $AV_{DD} = 5V$, 0dB CPI, SE
 (CPI input terminated)

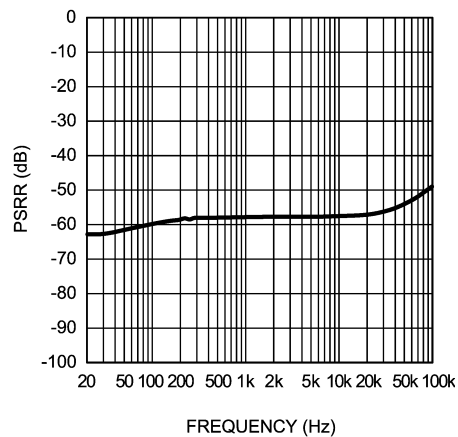

201341C9

Headphone PSRR vs Frequency
 $AV_{DD} = 3.3V$, 0dB DAC, SE
 (DAC input selected)

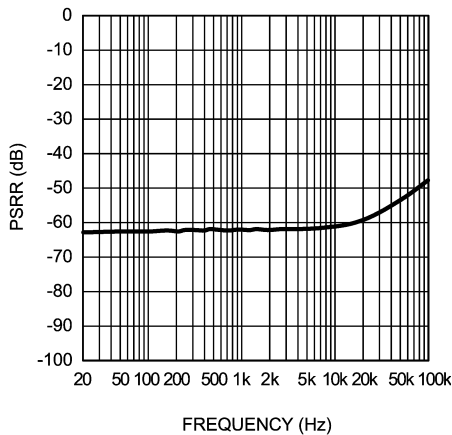

201341D0

Headphone PSRR vs Frequency
 $AV_{DD} = 5V$, 0dB DAC, SE
 (DAC input selected)

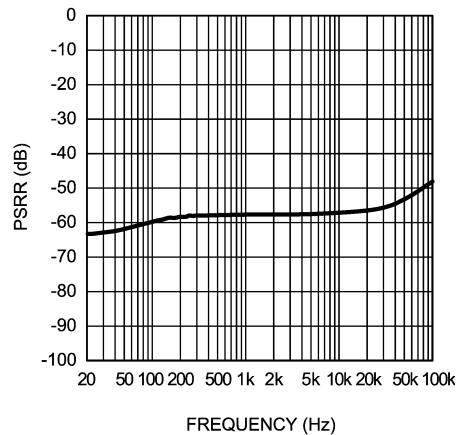

201341D1

13.0 Typical Performance Characteristics (Continued)

Loudspeaker PSRR vs Frequency
 $AV_{DD} = 3.3V, 0dB\ AUX$
 (AUX inputs terminated)

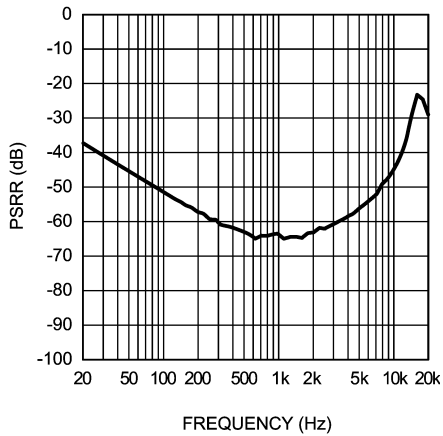

201341N6

Loudspeaker PSRR vs Frequency
 $AV_{DD} = 5V, 0dB\ AUX$
 (AUX inputs terminated)

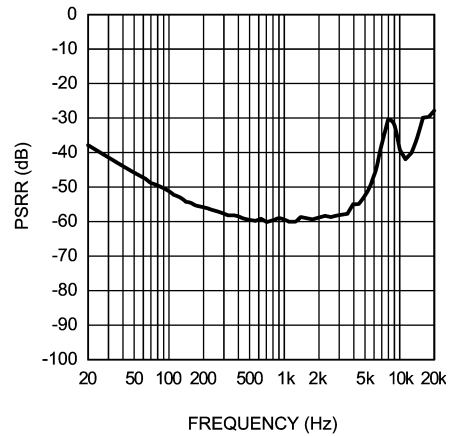

201341N7

Loudspeaker PSRR vs Frequency
 $AV_{DD} = 3.3V, 0dB\ CPI$
 (CPI input terminated)

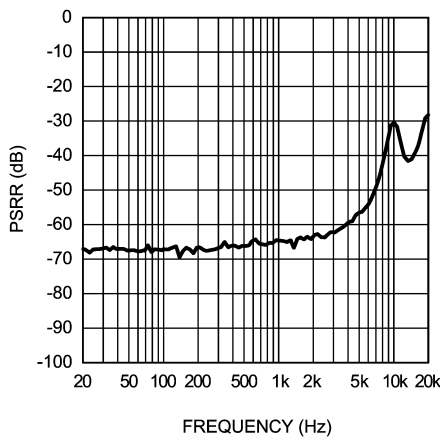

201341N8

Loudspeaker PSRR vs Frequency
 $AV_{DD} = 5V, 0dB\ CPI$
 (CPI input terminated)

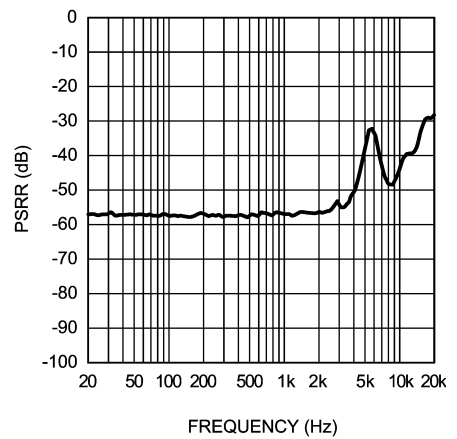

201341N9

Loudspeaker PSRR vs Frequency
 $AV_{DD} = 3.3V, 0dB\ DAC$
 (DAC input selected)

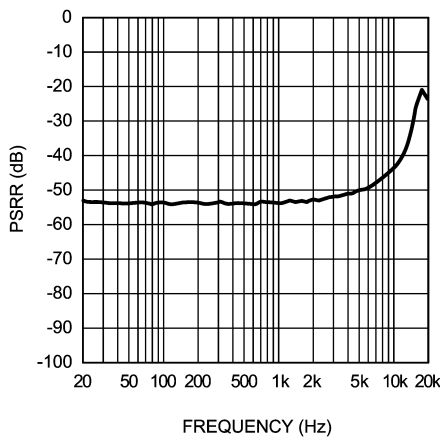

201341O0

Loudspeaker PSRR vs Frequency
 $AV_{DD} = 5V, 0dB\ DAC$
 (DAC input selected)

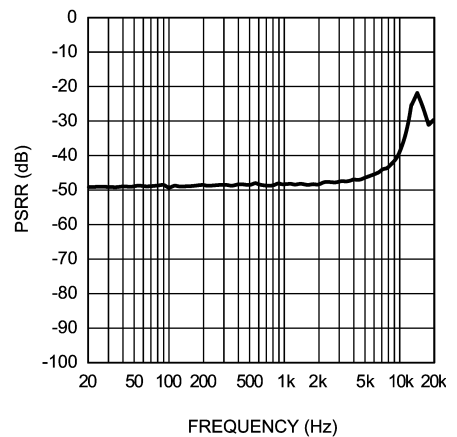

201341O1

13.0 Typical Performance Characteristics (Continued)

INT/EXT MICBIAS PSRR vs Frequency
 $AV_{DD} = 3.3V$, MICBIAS = 2.0V

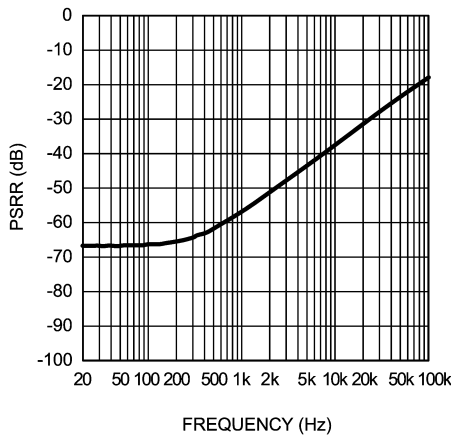

201341D2

INT/EXT MICBIAS PSRR vs Frequency
 $AV_{DD} = 5V$, MICBIAS = 2.0V

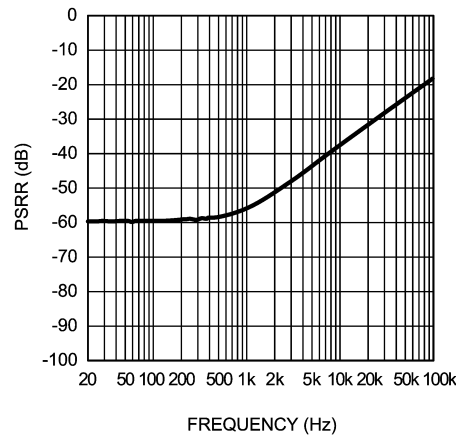

201341D3

INT/EXT MICBIAS PSRR vs Frequency
 $AV_{DD} = 3.3V$, MICBIAS = 2.5V

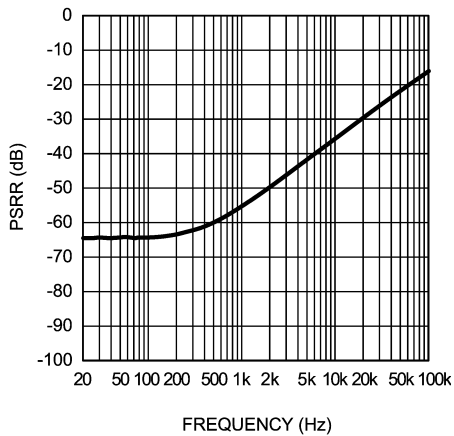

201341D4

INT/EXT MICBIAS PSRR vs Frequency
 $AV_{DD} = 5V$, MICBIAS = 2.5V

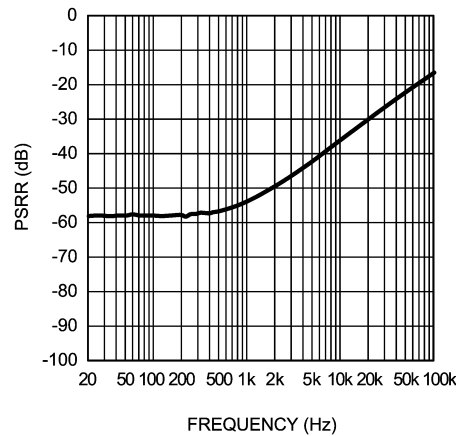

201341D5

INT/EXT MICBIAS PSRR vs Frequency
 $AV_{DD} = 3.3V$, MICBIAS = 2.8V

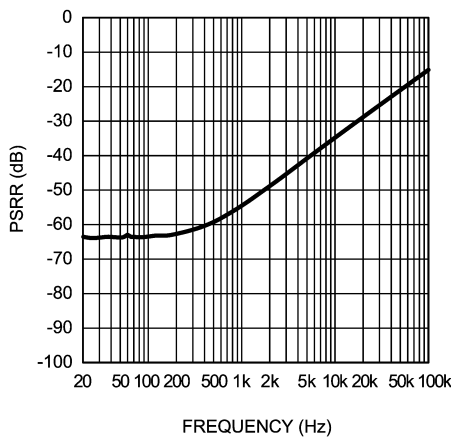

201341D6

INT/EXT MICBIAS PSRR vs Frequency
 $AV_{DD} = 5V$, MICBIAS = 2.8V

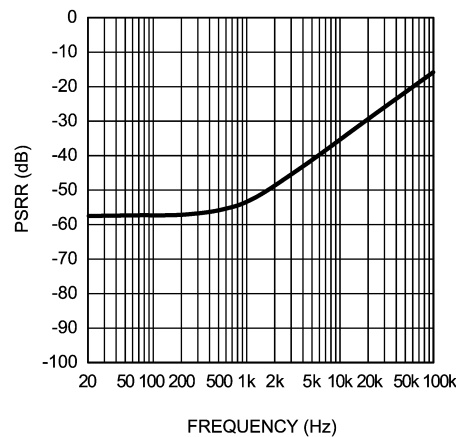

201341D7

13.0 Typical Performance Characteristics (Continued)

INT/EXT MICBIAS PSRR vs Frequency
 $AV_{DD} = 5V, MICBIAS = 3.3V$

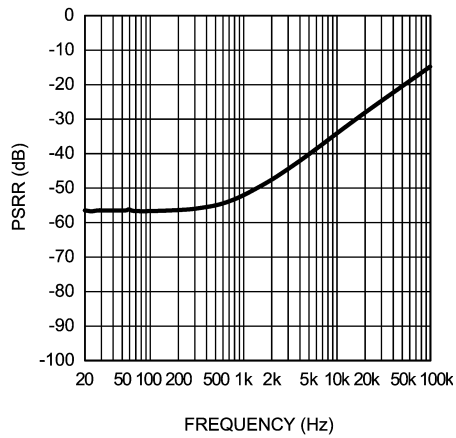

201341D8

AUXOUT THD+N vs Frequency
 $AV_{DD} = 3.3V, 0dB, V_{OUT} = 1V_{RMS}, 5k\Omega$

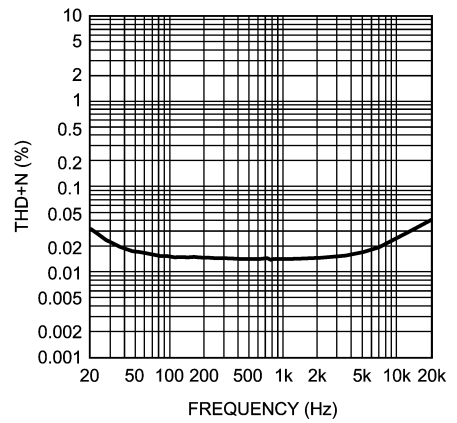

201341D9

AUXOUT THD+N vs Frequency
 $AV_{DD} = 5V, 0dB, V_{OUT} = 1V_{RMS}, 5k\Omega$

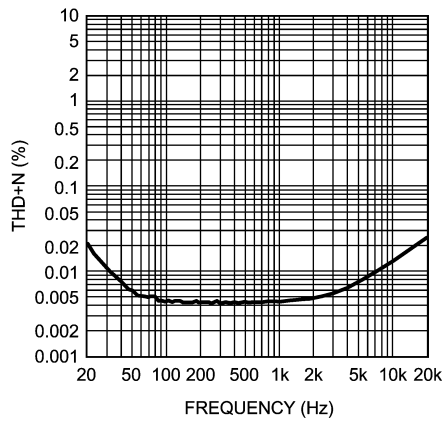

201341E0

CPOUT THD+N vs Frequency
 $AV_{DD} = 3.3V, 0dB, V_{OUT} = 1V_{RMS}, 5k\Omega$

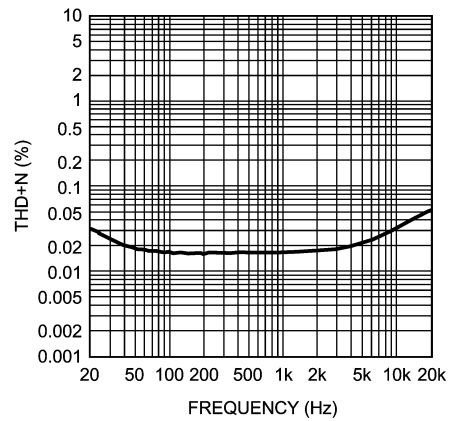

201341E1

CPOUT THD+N vs Frequency
 $AV_{DD} = 5V, 0dB, V_{OUT} = 1V_{RMS}, 5k\Omega$

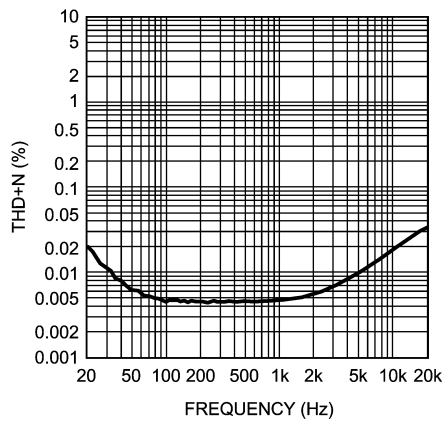

201341E2

Earpiece THD+N vs Frequency
 $AV_{DD} = 3.3V, 0dB, P_{OUT} = 500mW, 32\Omega$

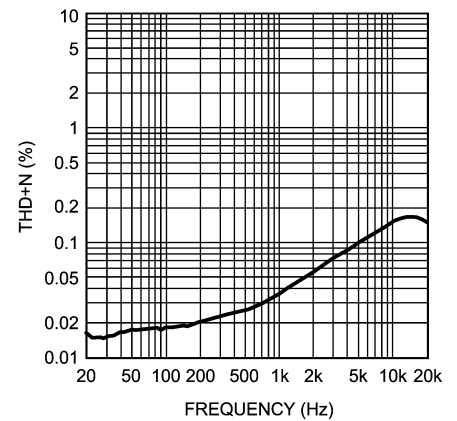

201341E3

13.0 Typical Performance Characteristics (Continued)

Earpiece THD+N vs Frequency
 $AV_{DD} = 5V, 0dB, P_{OUT} = 50mW, 32\Omega$

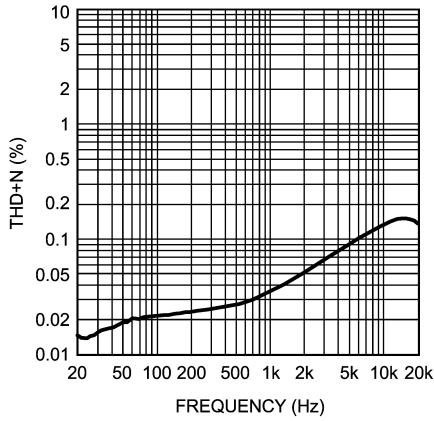

201341E4

Headphone THD+N vs Frequency
 $AV_{DD} = 3.3V, OCL 1.5V, 0dB$
 $P_{OUT} = 7.5mW, 32\Omega$

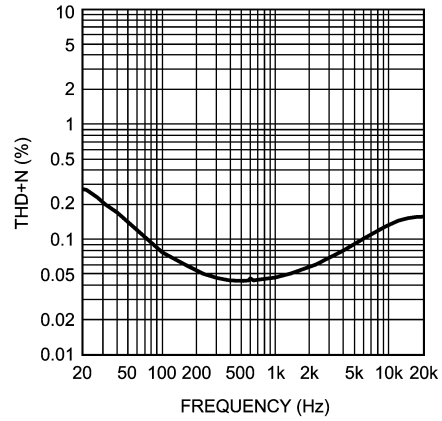

201341E5

Headphone THD+N vs Frequency
 $AV_{DD} = 5V, OCL 1.5V, 0dB$
 $P_{OUT} = 10mW, 32\Omega$

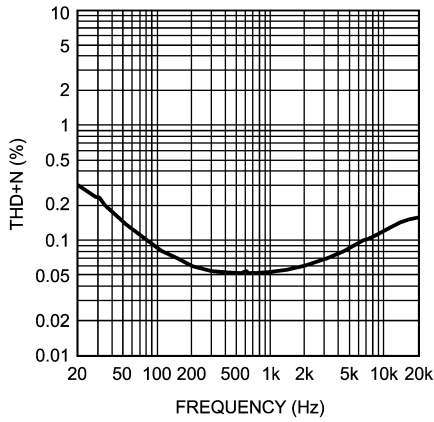

201341E6

Headphone THD+N vs Frequency
 $AV_{DD} = 3.3V, OCL 1.2V, 0dB$
 $P_{OUT} = 7.5mW, 32\Omega$

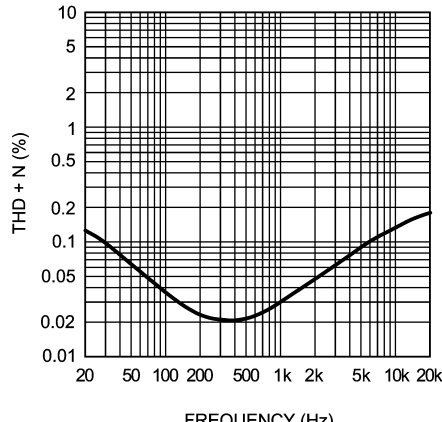

201341N1

Headphone THD+N vs Frequency
 $AV_{DD} = 5V, OCL 1.2V, 0dB$
 $P_{OUT} = 10mW, 32\Omega$

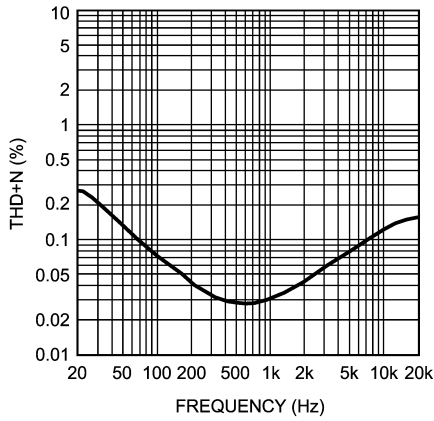

201341E7

Headphone THD+N vs Frequency
 $AV_{DD} = 3.3V, SE, 0dB$
 $P_{OUT} = 7.5mW, 32\Omega$

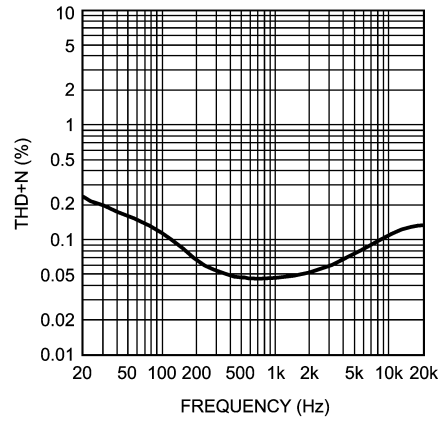

201341E8

13.0 Typical Performance Characteristics (Continued)

Headphone THD+N vs Frequency

$AV_{DD} = 5V$, SE, 0dB
 $P_{OUT} = 10mW$, 32Ω

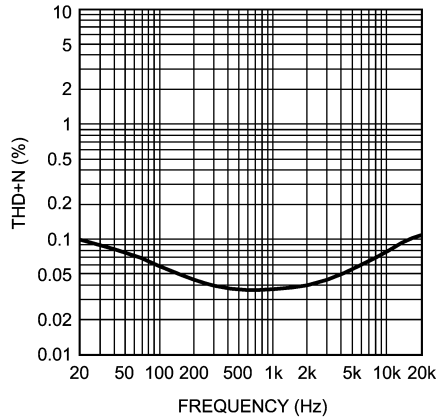

201341E9

Loudspeaker THD+N vs Frequency

$AV_{DD} = 3.3V$, $P_{OUT} = 400mW$
 $15\mu H + 8\Omega + 15\mu H$

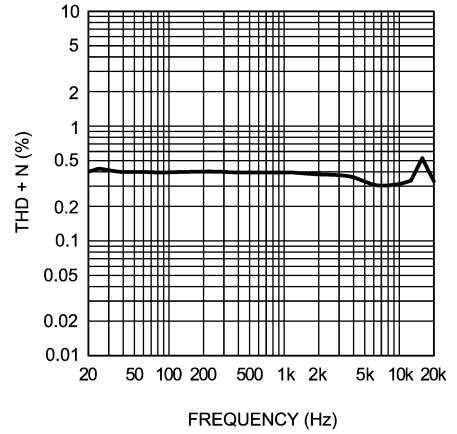

201341O2

Loudspeaker THD+N vs Frequency

$AV_{DD} = 5V$, $P_{OUT} = 400mW$
 $15\mu H + 8\Omega + 15\mu H$

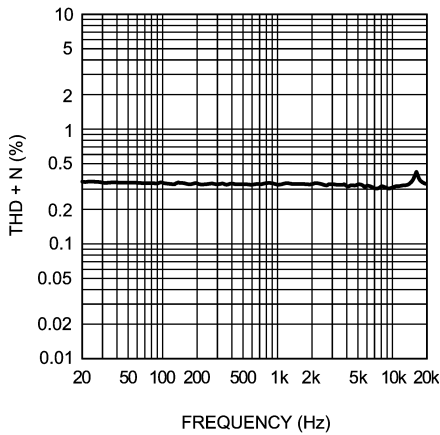

201341O3

Earpiece THD+N vs Output Power

$AV_{DD} = 3.3V$, 0dB AUX
 $f_{OUT} = 1kHz$, 16Ω

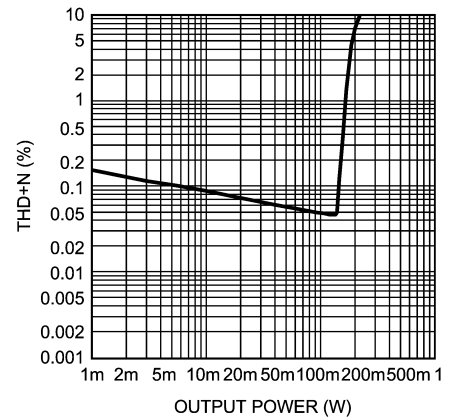

201341F0

Earpiece THD+N vs Output Power

$AV_{DD} = 5V$, 0dB AUX
 $f_{OUT} = 1kHz$, 16Ω

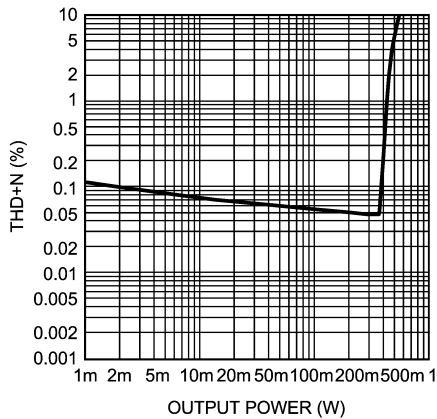

201341F1

Earpiece THD+N vs Output Power

$AV_{DD} = 3.3V$, 0dB AUX
 $f_{OUT} = 1kHz$, 32Ω

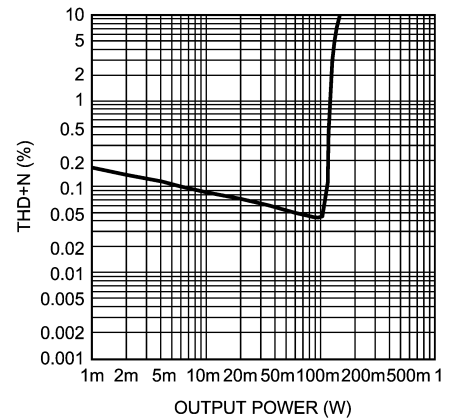

201341F2

13.0 Typical Performance Characteristics (Continued)

Earpiece THD+N vs Output Power

$AV_{DD} = 5V, 0dB\text{ AUX}$
 $f_{OUT} = 1kHz, 32\Omega$

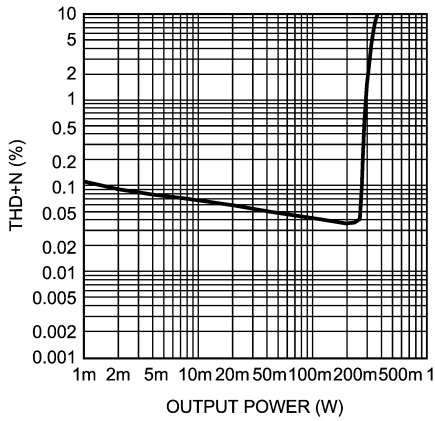

201341F3

Earpiece THD+N vs Output Power

$AV_{DD} = 3.3V, 0dB\text{ CPI}$
 $f_{OUT} = 1kHz, 16\Omega$

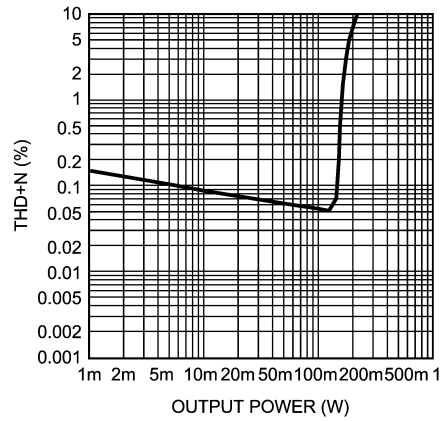

201341F4

Earpiece THD+N vs Output Power

$AV_{DD} = 5V, 0dB\text{ CPI}$
 $f_{OUT} = 1kHz, 16\Omega$

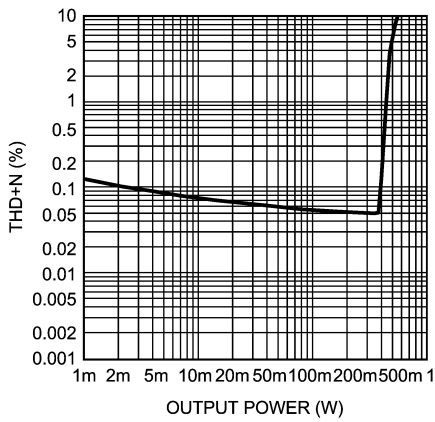

201341F5

Earpiece THD+N vs Output Power

$AV_{DD} = 3.3V, 0dB\text{ CPI}$
 $f_{OUT} = 1kHz, 32\Omega$

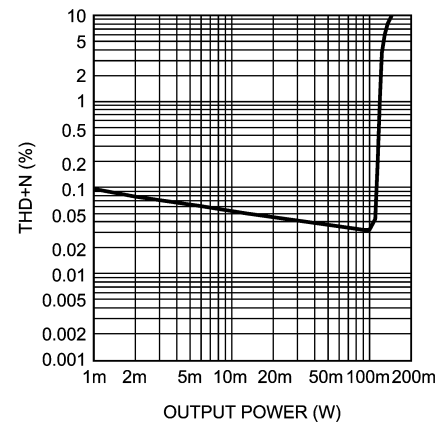

201341F6

Earpiece THD+N vs Output Power

$AV_{DD} = 5V, 0dB\text{ CPI}$
 $f_{OUT} = 1kHz, 32\Omega$

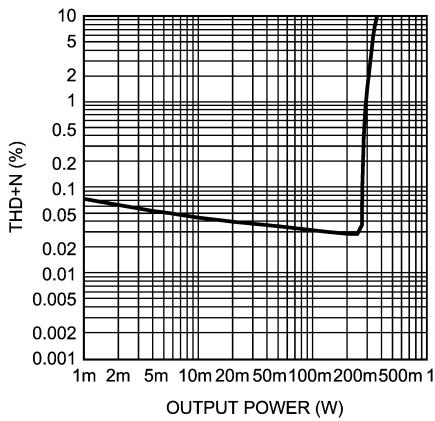

201341F7

Headphone THD+N vs Output Power

$AV_{DD} = 3.3V, OCL\ 1.2V, 0dB\text{ DAC}$
 $f_{OUT} = 1kHz, 16\Omega$

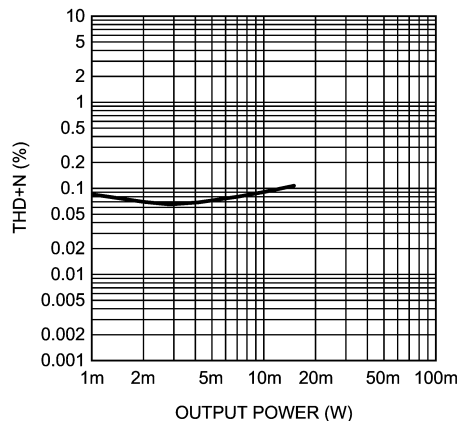

201341F8

13.0 Typical Performance Characteristics (Continued)

Headphone THD+N vs Output Power
 $AV_{DD} = 5V$, OCL 1.2V, 0dB DAC
 $f_{OUT} = 1kHz, 16\Omega$

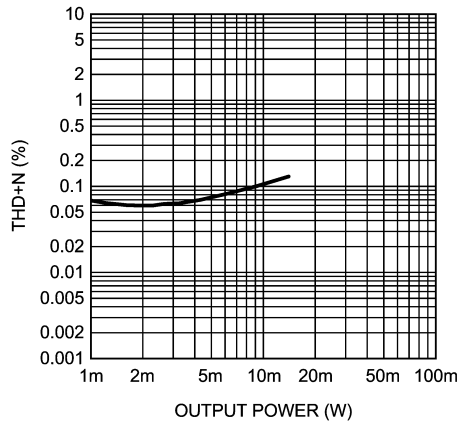

201341F9

Headphone THD+N vs Output Power
 $AV_{DD} = 3.3V$, OCL 1.2V, 0dB DAC
 $f_{OUT} = 1kHz, 32\Omega$

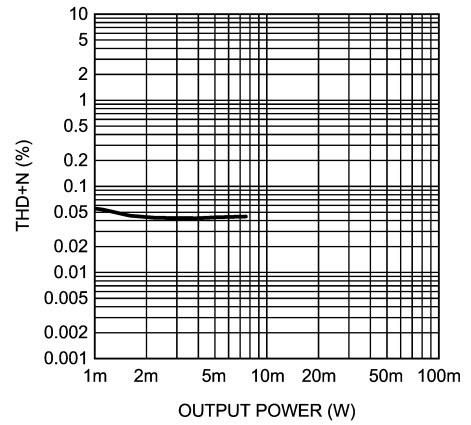

201341G0

Headphone THD+N vs Output Power
 $AV_{DD} = 5V$, OCL 1.2V, 0dB DAC
 $f_{OUT} = 1kHz, 32\Omega$

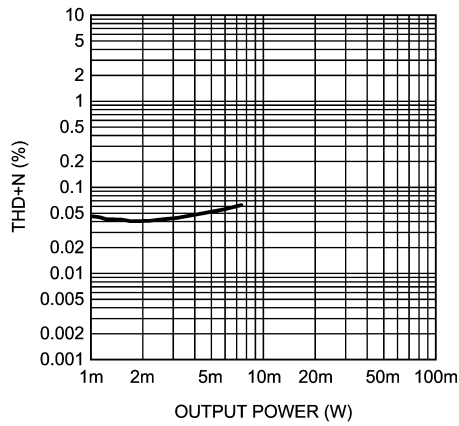

201341G1

Headphone THD+N vs Output Power
 $AV_{DD} = 3.3V$, OCL 1.2V, 12dB DAC
 $f_{OUT} = 1kHz, 16\Omega$

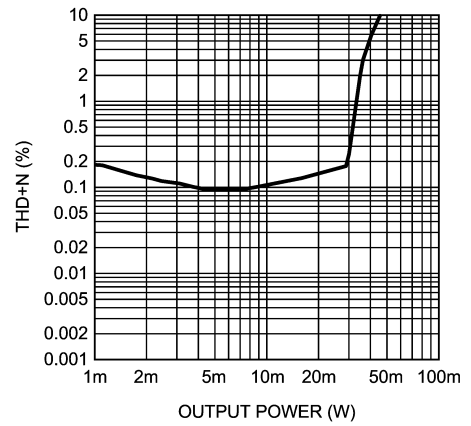

201341G2

Headphone THD+N vs Output Power
 $AV_{DD} = 5V$, OCL 1.2V, 12dB DAC
 $f_{OUT} = 1kHz, 16\Omega$

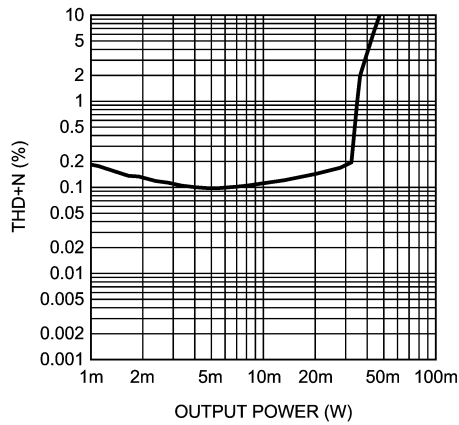

201341G3

Headphone THD+N vs Output Power
 $AV_{DD} = 3.3V$, OCL 1.2V, 12dB DAC
 $f_{OUT} = 1kHz, 32\Omega$

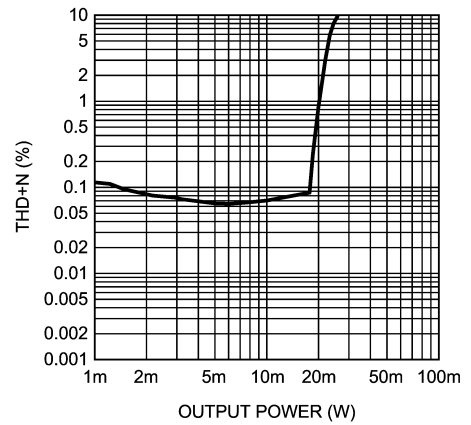

201341G4

13.0 Typical Performance Characteristics (Continued)

Headphone THD+N vs Output Power
 $AV_{DD} = 5V$, OCL 1.2V, 12dB DAC
 $f_{OUT} = 1kHz$, 32Ω

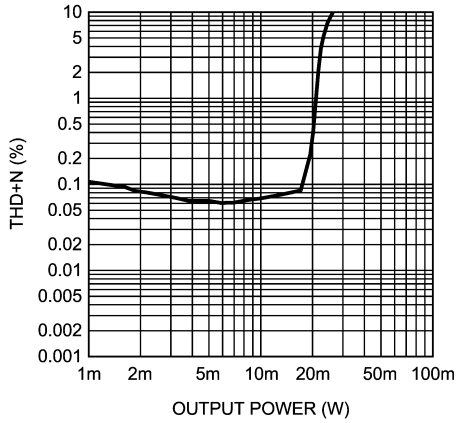

201341G5

Headphone THD+N vs Output Power
 $AV_{DD} = 3.3V$, OCL 1.5V, 0dB DAC
 $f_{OUT} = 1kHz$, 16Ω

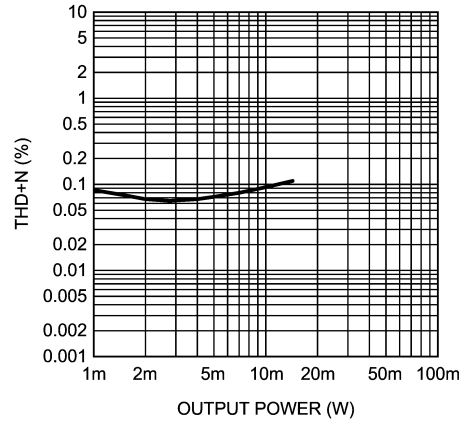

201341G6

Headphone THD+N vs Output Power
 $AV_{DD} = 5V$, OCL 1.5V, 0dB DAC
 $f_{OUT} = 1kHz$, 16Ω

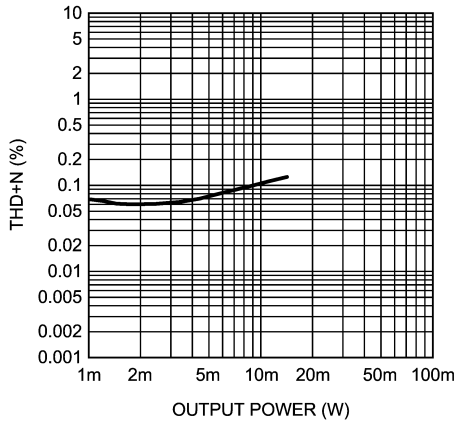

201341G7

Headphone THD+N vs Output Power
 $AV_{DD} = 3.3V$, OCL 1.5V, 0dB DAC
 $f_{OUT} = 1kHz$, 32Ω

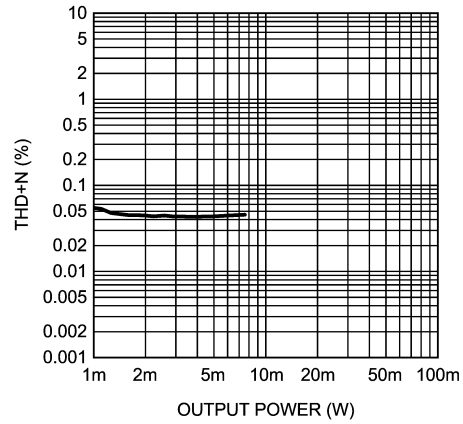

201341G8

Headphone THD+N vs Output Power
 $AV_{DD} = 5V$, OCL 1.5V, 0dB DAC
 $f_{OUT} = 1kHz$, 32Ω

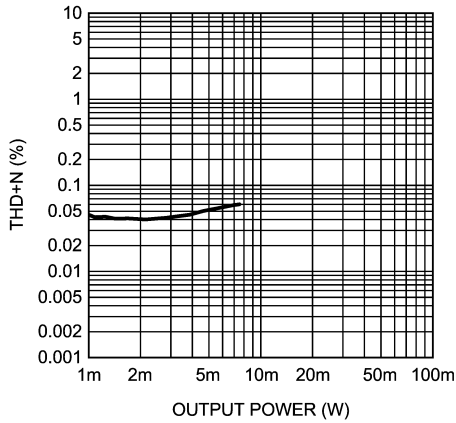

201341G9

Headphone THD+N vs Output Power
 $AV_{DD} = 3.3V$, OCL 1.5V, 12dB DAC
 $f_{OUT} = 1kHz$, 16Ω

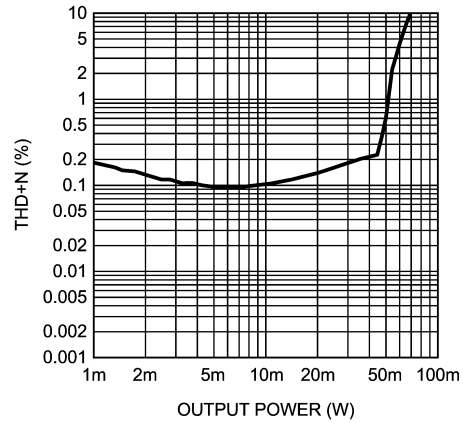

201341H0

13.0 Typical Performance Characteristics (Continued)

Headphone THD+N vs Output Power
 $AV_{DD} = 5V$, OCL 1.5V, 12dB DAC
 $f_{OUT} = 1kHz$, 16Ω

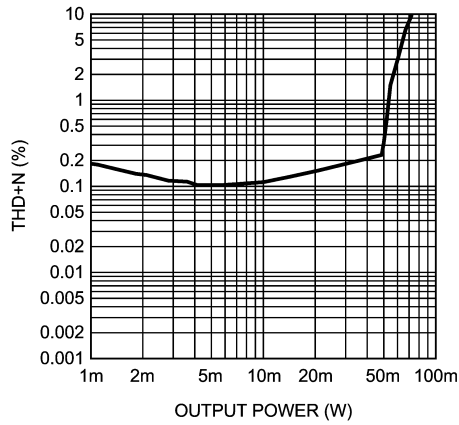

201341H1

Headphone THD+N vs Output Power
 $AV_{DD} = 3.3V$, OCL 1.5V, 12dB DAC
 $f_{OUT} = 1kHz$, 32Ω

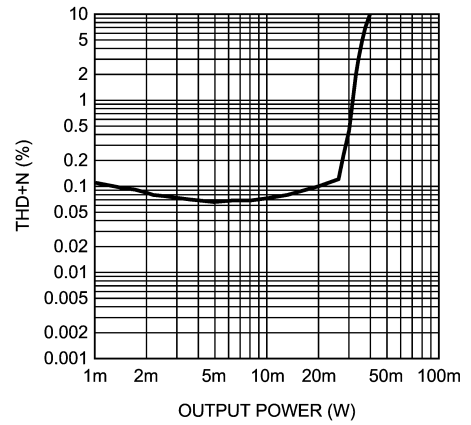

201341H2

Headphone THD+N vs Output Power
 $AV_{DD} = 5V$, OCL 1.5V, 12dB DAC
 $f_{OUT} = 1kHz$, 32Ω

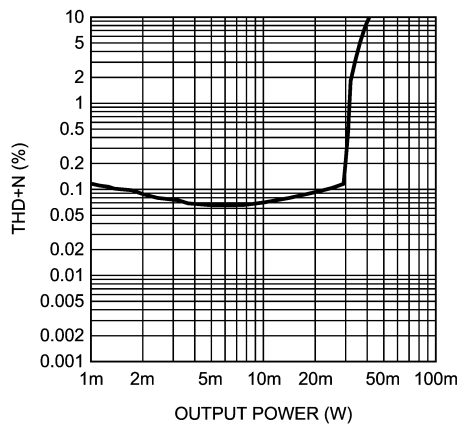

201341H3

Headphone THD+N vs Output Power
 $AV_{DD} = 3.3V$, SE, 0dB DAC
 $f_{OUT} = 1kHz$, 16Ω

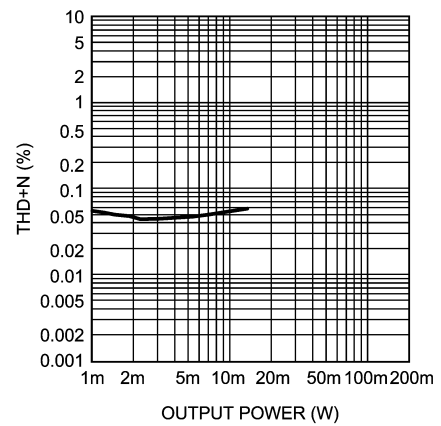

201341H4

Headphone THD+N vs Output Power
 $AV_{DD} = 5V$, SE, 0dB DAC
 $f_{OUT} = 1kHz$, 16Ω

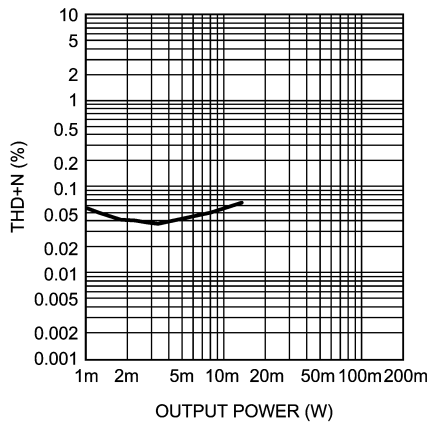

201341H5

Headphone THD+N vs Output Power
 $AV_{DD} = 3.3V$, SE, 0dB DAC
 $f_{OUT} = 1kHz$, 32Ω

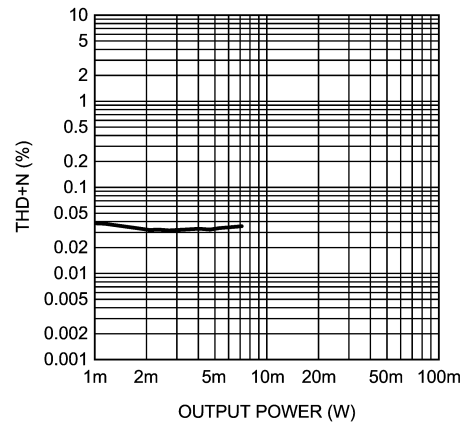

201341H6

13.0 Typical Performance Characteristics (Continued)

Headphone THD+N vs Output Power
 $AV_{DD} = 5V$, SE, 0dB DAC
 $f_{OUT} = 1kHz$, 32Ω

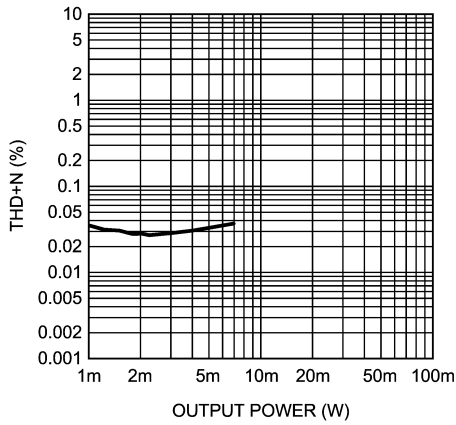

201341H7

Headphone THD+N vs Output Power
 $AV_{DD} = 3.3V$, SE, 12dB DAC
 $f_{OUT} = 1kHz$, 16Ω

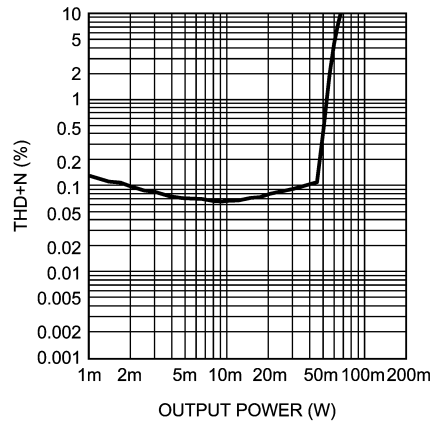

201341H8

Headphone THD+N vs Output Power
 $AV_{DD} = 5V$, SE, 12dB DAC
 $f_{OUT} = 1kHz$, 16Ω

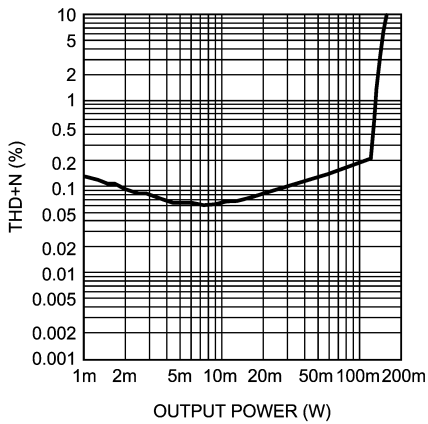

201341H9

Headphone THD+N vs Output Power
 $AV_{DD} = 3.3V$, SE, 12dB DAC
 $f_{OUT} = 1kHz$, 32Ω

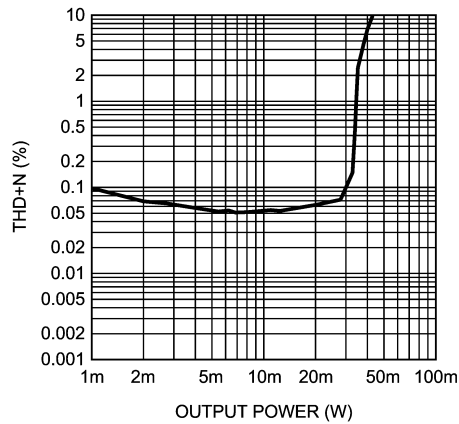

20134110

Headphone THD+N vs Output Power
 $AV_{DD} = 5V$, SE, 12dB DAC
 $f_{OUT} = 1kHz$, 32Ω

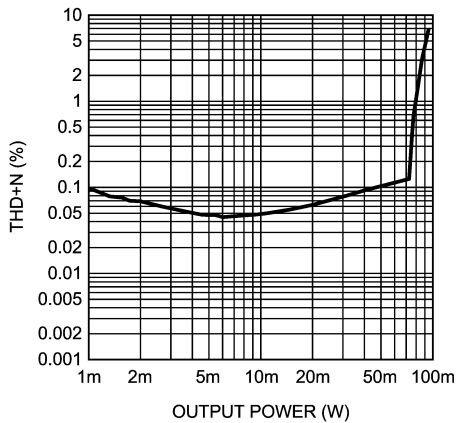

20134111

Headphone THD+N vs Output Power
 $AV_{DD} = 3.3V$, OCL 1.2V, 0dB AUX
 $f_{OUT} = 1kHz$, 16Ω

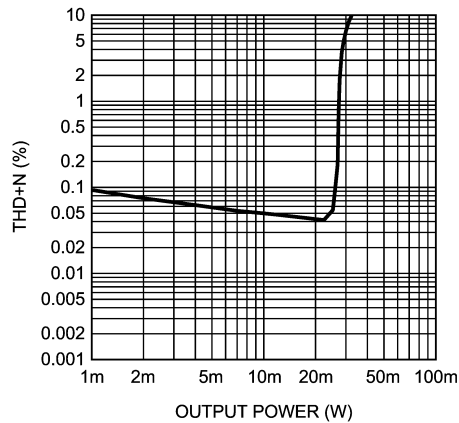

20134112

13.0 Typical Performance Characteristics (Continued)

Headphone THD+N vs Output Power
 $AV_{DD} = 3.3V$, OCL 1.2V, 12dB AUX
 $f_{OUT} = 1kHz$, 16Ω

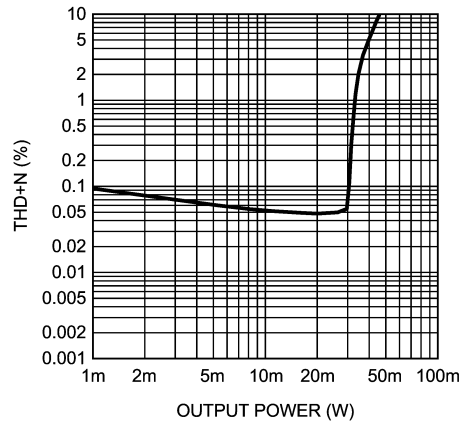

20134113

Headphone THD+N vs Output Power
 $AV_{DD} = 5V$, OCL 1.2V, 0dB AUX
 $f_{OUT} = 1kHz$, 16Ω

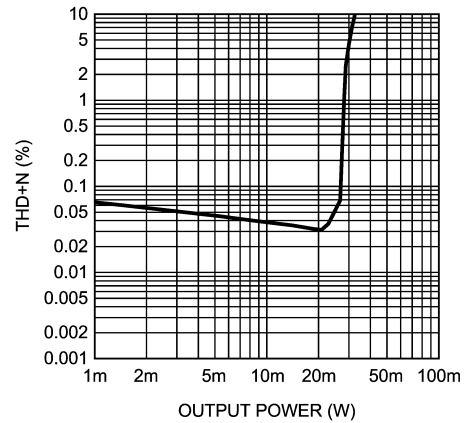

20134114

Headphone THD+N vs Output Power
 $AV_{DD} = 5V$, OCL 1.2V, 12dB AUX
 $f_{OUT} = 1kHz$, 16Ω

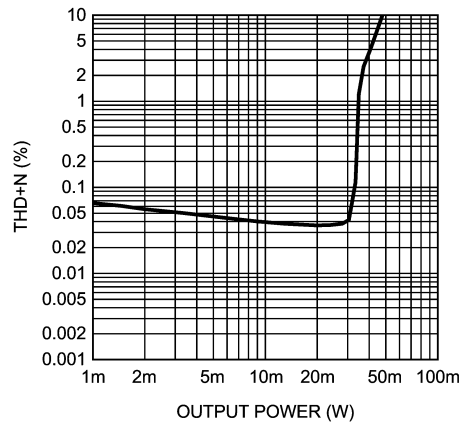

20134115

Headphone THD+N vs Output Power
 $AV_{DD} = 3.3V$, OCL 1.2V, 0dB AUX
 $f_{OUT} = 1kHz$, 32Ω

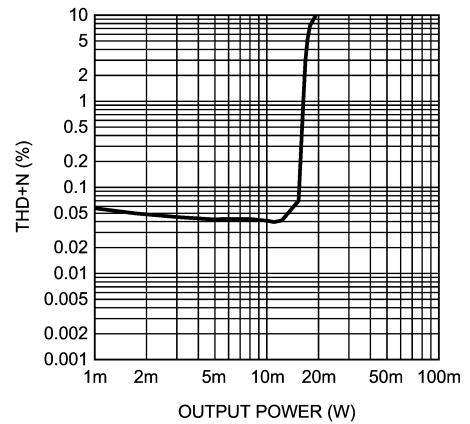

20134116

Headphone THD+N vs Output Power
 $AV_{DD} = 3.3V$, OCL 1.2V, 12dB AUX
 $f_{OUT} = 1kHz$, 32Ω

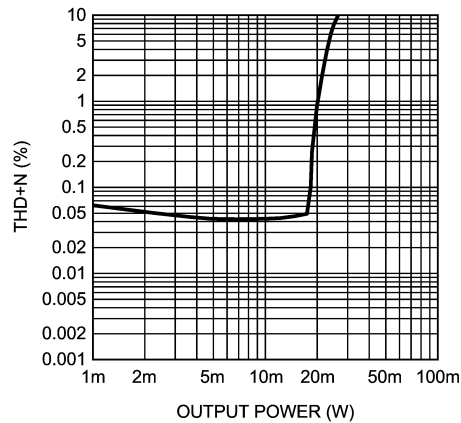

20134117

Headphone THD+N vs Output Power
 $AV_{DD} = 5V$, OCL 1.2V, 0dB AUX
 $f_{OUT} = 1kHz$, 32Ω

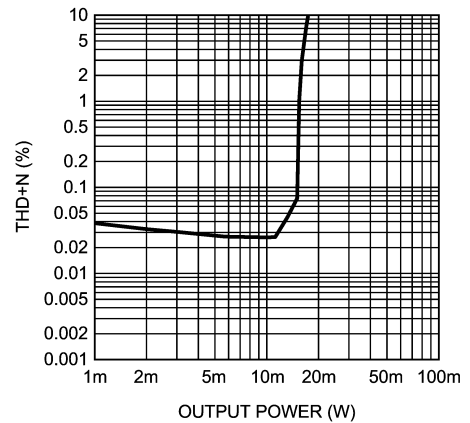

20134118

13.0 Typical Performance Characteristics (Continued)

Headphone THD+N vs Output Power

$AV_{DD} = 5V$, OCL 1.2V, 12dB AUX
 $f_{OUT} = 1kHz$, 32Ω

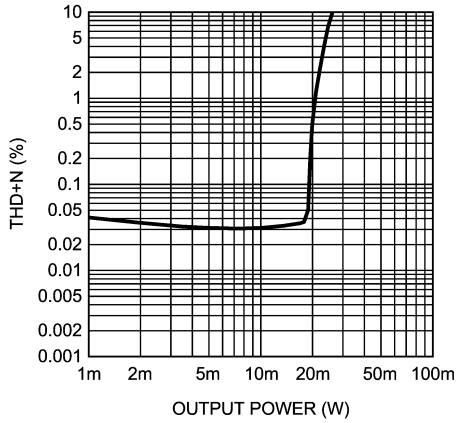

201341I9

Headphone THD+N vs Output Power

$AV_{DD} = 3.3V$, OCL 1.2V, 0dB CPI
 $f_{OUT} = 1kHz$, 16Ω

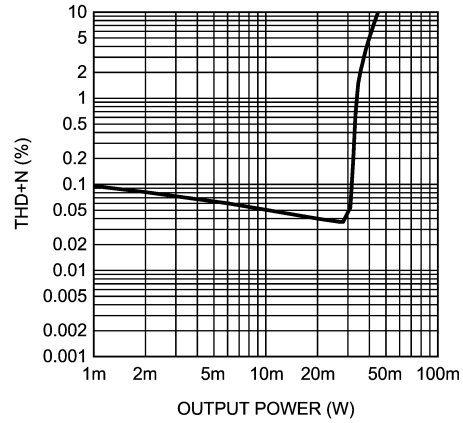

201341J0

Headphone THD+N vs Output Power

$AV_{DD} = 5V$, OCL 1.2V, 0dB CPI
 $f_{OUT} = 1kHz$, 16Ω

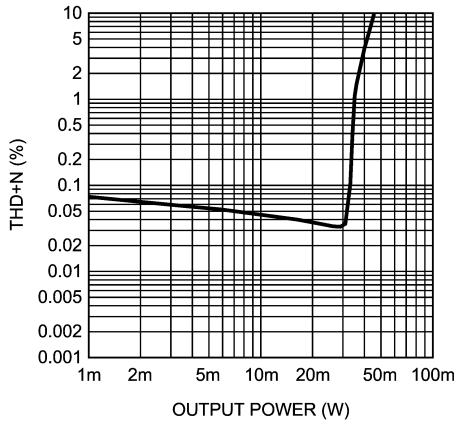

201341J1

Headphone THD+N vs Output Power

$AV_{DD} = 3.3V$, OCL 1.2V, 0dB CPI
 $f_{OUT} = 1kHz$, 32Ω

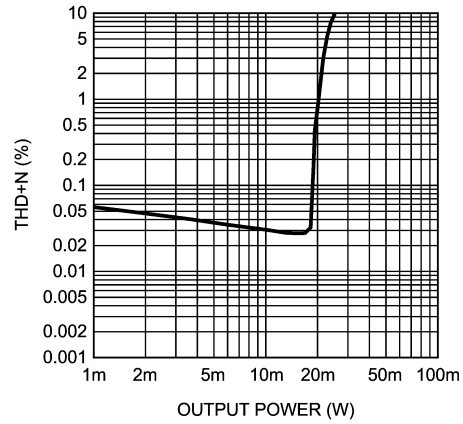

201341J2

Headphone THD+N vs Output Power

$AV_{DD} = 5V$, OCL 1.2V, 0dB CPI
 $f_{OUT} = 1kHz$, 32Ω

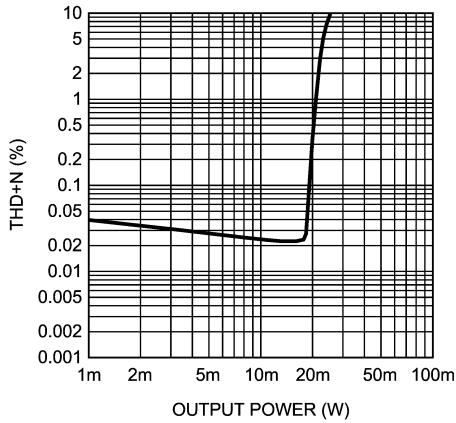

201341J3

Headphone THD+N vs Output Power

$AV_{DD} = 3.3V$, OCL 1.5V, 0dB AUX
 $f_{OUT} = 1kHz$, 16Ω

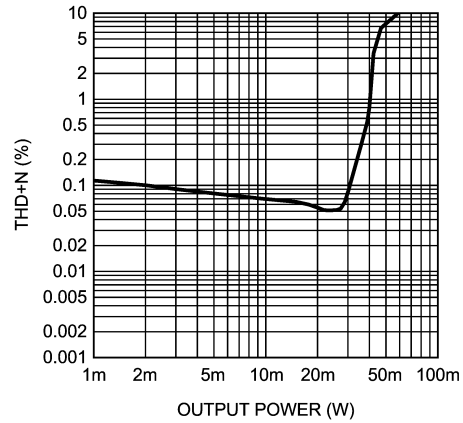

201341J4

13.0 Typical Performance Characteristics (Continued)

Headphone THD+N vs Output Power
 $AV_{DD} = 3.3V$, OCL 1.5V, 12dB AUX
 $f_{OUT} = 1kHz$, 16Ω

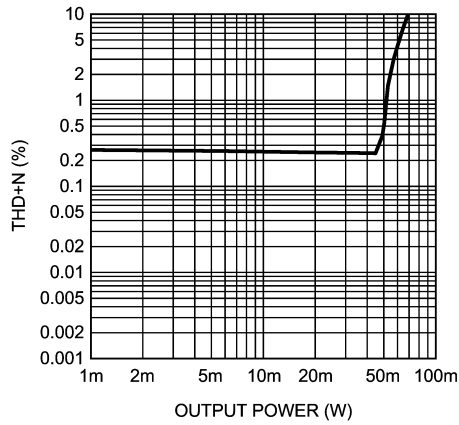

201341J5

Headphone THD+N vs Output Power
 $AV_{DD} = 5V$, OCL 1.5V, 0dB AUX
 $f_{OUT} = 1kHz$, 16Ω

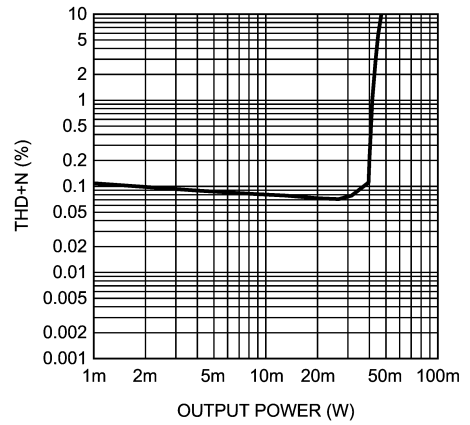

201341J6

Headphone THD+N vs Output Power
 $AV_{DD} = 5V$, OCL 1.5V, 12dB AUX
 $f_{OUT} = 1kHz$, 16Ω

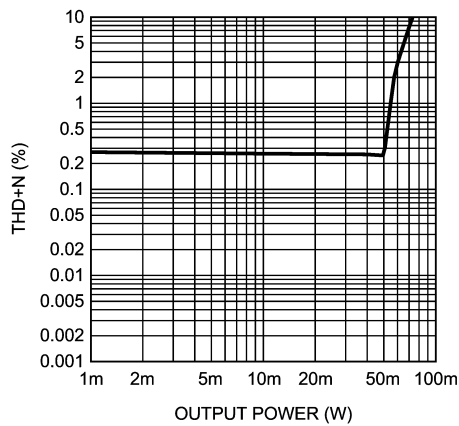

201341J7

Headphone THD+N vs Output Power
 $AV_{DD} = 3.3V$, OCL 1.5V, 0dB AUX
 $f_{OUT} = 1kHz$, 32Ω

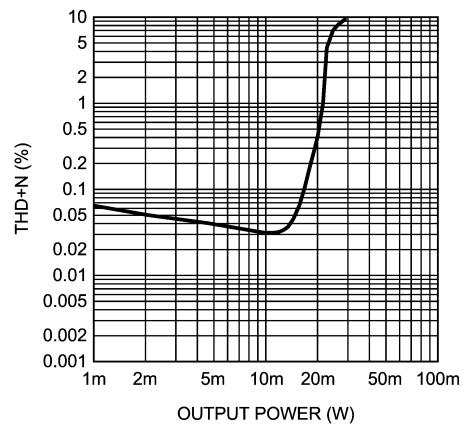

201341J8

Headphone THD+N vs Output Power
 $AV_{DD} = 3.3V$, OCL 1.5V, 12dB AUX
 $f_{OUT} = 1kHz$, 32Ω

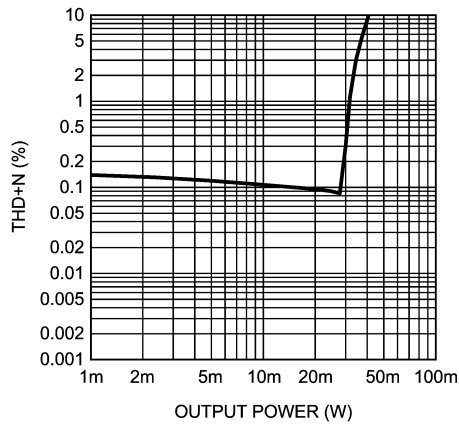

201341J9

Headphone THD+N vs Output Power
 $AV_{DD} = 5V$, OCL 1.5V, 0dB AUX
 $f_{OUT} = 1kHz$, 32Ω

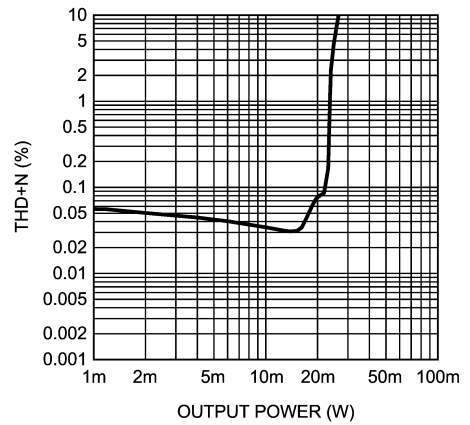

201341K0

13.0 Typical Performance Characteristics (Continued)

Headphone THD+N vs Output Power

$AV_{DD} = 5V$, OCL 1.5V, 12dB AUX
 $f_{OUT} = 1kHz$, 32Ω

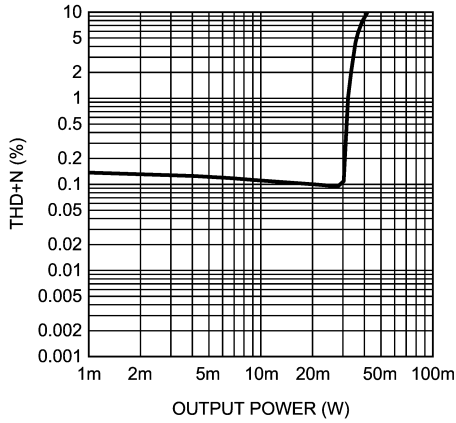

201341K1

Headphone THD+N vs Output Power

$AV_{DD} = 3.3V$, OCL 1.5V, 0dB CPI
 $f_{OUT} = 1kHz$, 16Ω

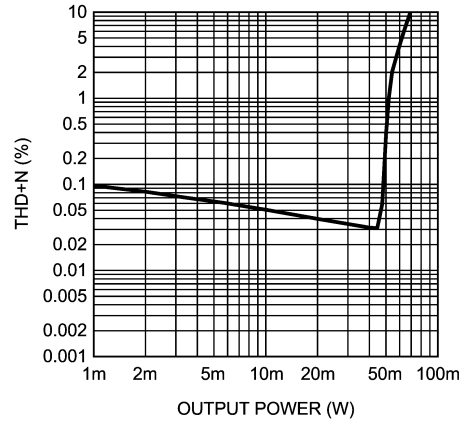

201341K2

Headphone THD+N vs Output Power

$AV_{DD} = 5V$, OCL 1.5V, 0dB CPI
 $f_{OUT} = 1kHz$, 16Ω

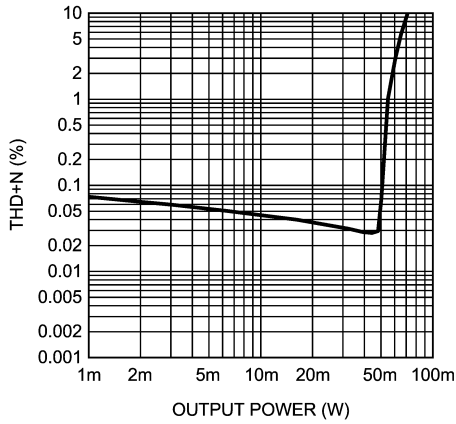

201341K3

Headphone THD+N vs Output Power

$AV_{DD} = 3.3V$, OCL 1.5V, 0dB CPI
 $f_{OUT} = 1kHz$, 32Ω

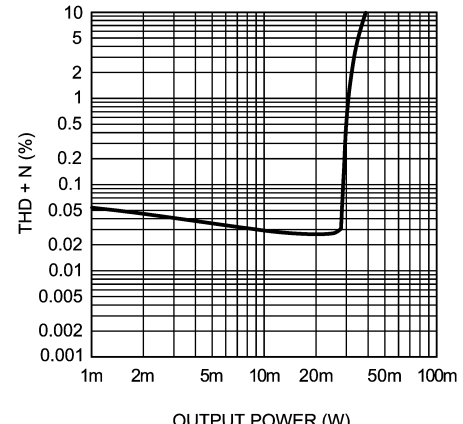

201341N2

Headphone THD+N vs Output Power

$AV_{DD} = 5V$, OCL 1.5V, 0dB CPI
 $f_{OUT} = 1kHz$, 32Ω

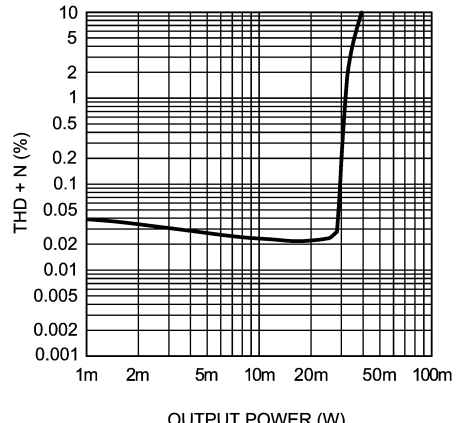

201341N3

Headphone THD+N vs Output Power

$AV_{DD} = 3.3V$, SE, 0dB AUX
 $f_{OUT} = 1kHz$, 16Ω

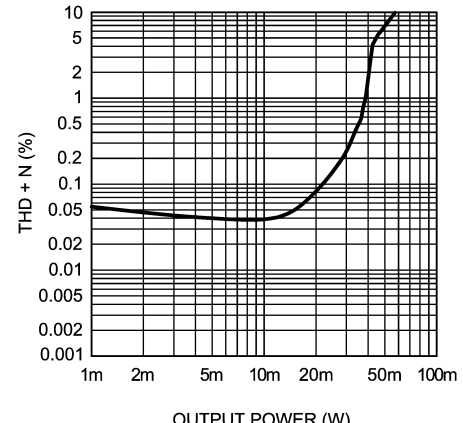

201341N4

13.0 Typical Performance Characteristics (Continued)

Headphone THD+N vs Output Power
 $AV_{DD} = 5V$, SE, 0dB AUX
 $f_{OUT} = 1kHz$, 16Ω

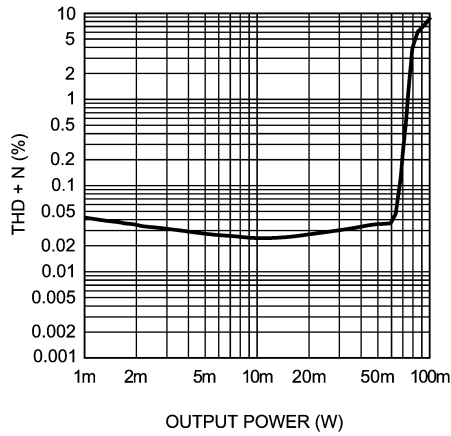

201341N5

Headphone THD+N vs Output Power
 $AV_{DD} = 3.3V$, SE, 0dB AUX
 $f_{OUT} = 1kHz$, 32Ω

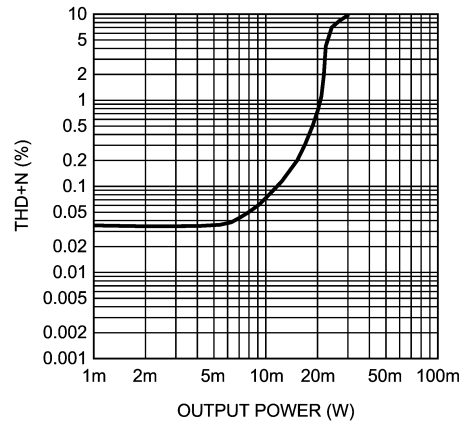

201341K4

Headphone THD+N vs Output Power
 $AV_{DD} = 5V$, SE, 0dB AUX
 $f_{OUT} = 1kHz$, 32Ω

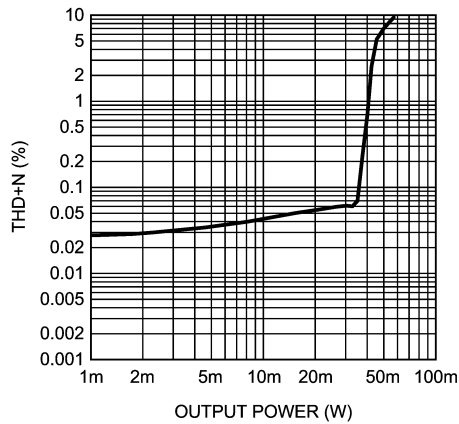

201341K5

Headphone THD+N vs Output Power
 $AV_{DD} = 3.3V$, SE, 0dB CPI
 $f_{OUT} = 1kHz$, 16Ω

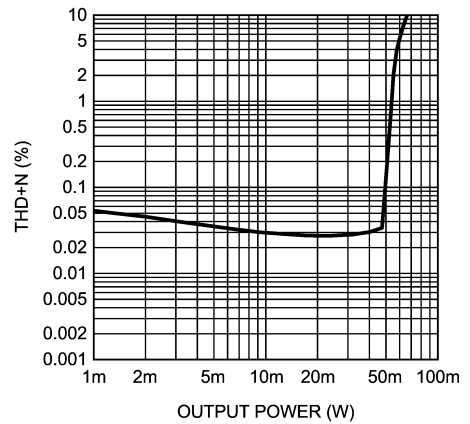

201341K6

Headphone THD+N vs Output Power
 $AV_{DD} = 5V$, SE, 0dB CPI
 $f_{OUT} = 1kHz$, 16Ω

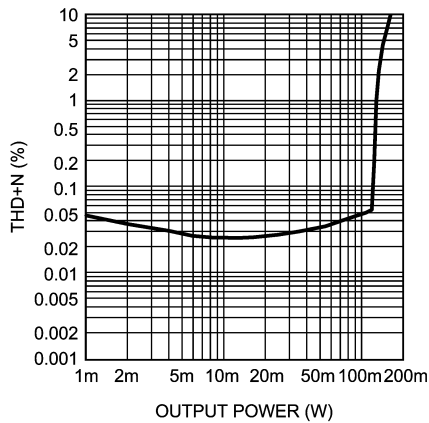

201341K7

Headphone THD+N vs Output Power
 $AV_{DD} = 3.3V$, SE, 0dB CPI
 $f_{OUT} = 1kHz$, 32Ω

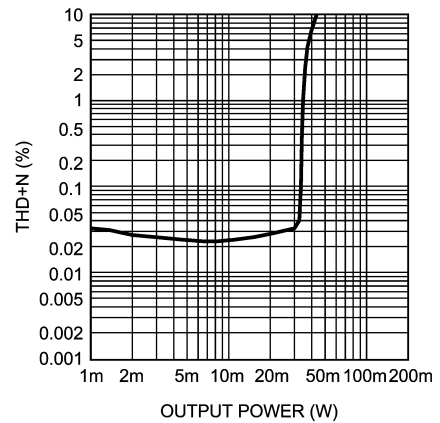

201341K8

13.0 Typical Performance Characteristics (Continued)

Headphone THD+N vs Output Power

$AV_{DD} = 5V, SE, 0dB\ CPI$
 $f_{OUT} = 1kHz, 32\Omega$

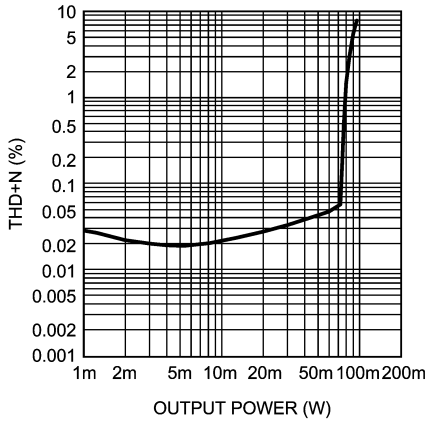

201341K9

Loudspeaker THD+N vs Output Power

$AV_{DD} = 3.3V, 0dB\ AUX$
 $f_{OUT} = 1kHz, 15\mu H+8\Omega+15\mu H$

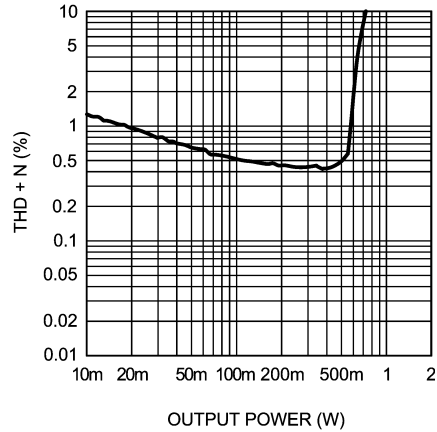

201341O4

Loudspeaker THD+N vs Output Power

$AV_{DD} = 4.2V, 0dB\ AUX$
 $f_{OUT} = 1kHz, 15\mu H+8\Omega+15\mu H$

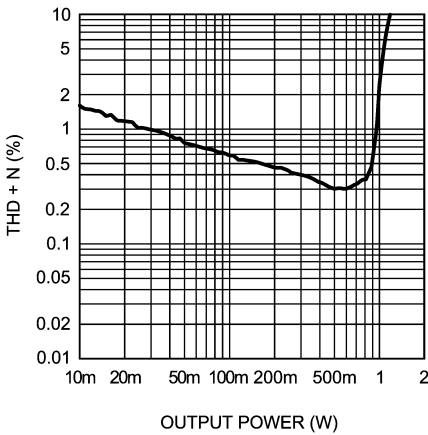

201341O5

Loudspeaker THD+N vs Output Power

$AV_{DD} = 5V, 0dB\ AUX$
 $f_{OUT} = 1kHz, 15\mu H+8\Omega+15\mu H$

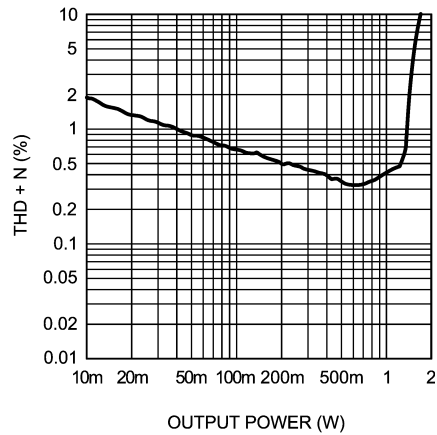

201341O6

Loudspeaker THD+N vs Output Power

$AV_{DD} = 3.3V, 0dB\ CPI$
 $f_{OUT} = 1kHz, 15\mu H+8\Omega+15\mu H$

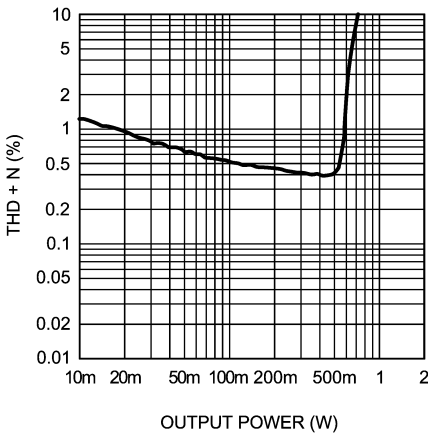

201341O7

Loudspeaker THD+N vs Output Power

$AV_{DD} = 4.2V, 0dB\ CPI$
 $f_{OUT} = 1kHz, 15\mu H+8\Omega+15\mu H$

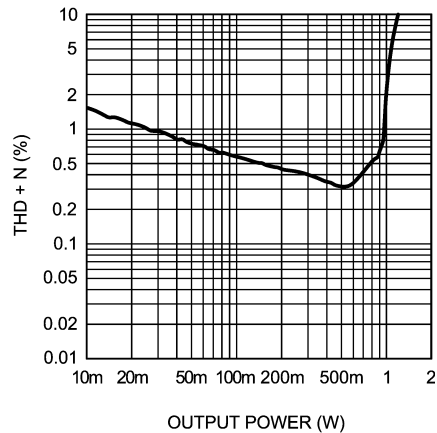

201341O8

13.0 Typical Performance Characteristics (Continued)

Loudspeaker THD+N vs Output Power
 $AV_{DD} = 5V, 0dB\ CPI$
 $f_{OUT} = 1kHz, 15\mu H+8\Omega+15\mu H$

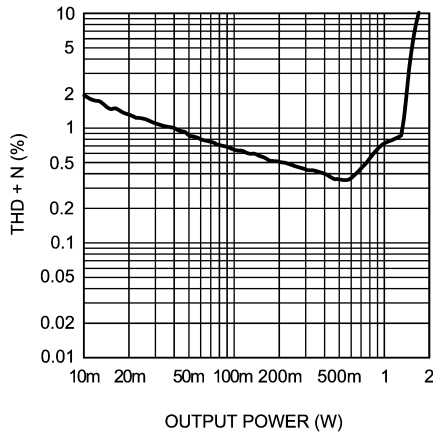

201341O9

Loudspeaker THD+N vs Output Power
 $AV_{DD} = 3.3V, 0dB\ DAC$
 $f_{OUT} = 1kHz, 15\mu H+8\Omega+15\mu H$

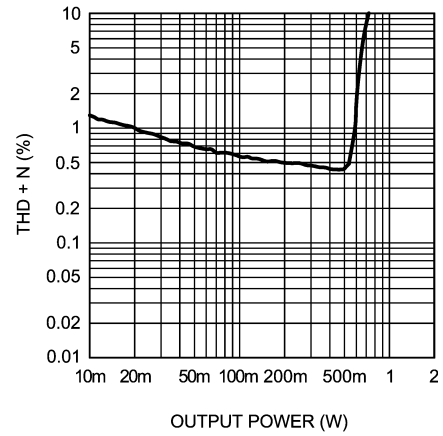

201341P0

Loudspeaker THD+N vs Output Power
 $AV_{DD} = 4.2V, 0dB\ DAC$
 $f_{OUT} = 1kHz, 15\mu H+8\Omega+15\mu H$

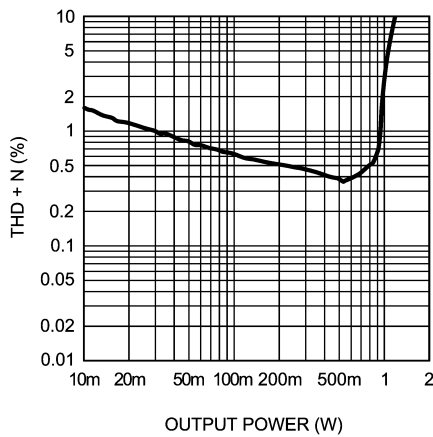

201341P1

Loudspeaker THD+N vs Output Power
 $AV_{DD} = 5V, 0dB\ DAC$
 $f_{OUT} = 1kHz, 15\mu H+8\Omega+15\mu H$

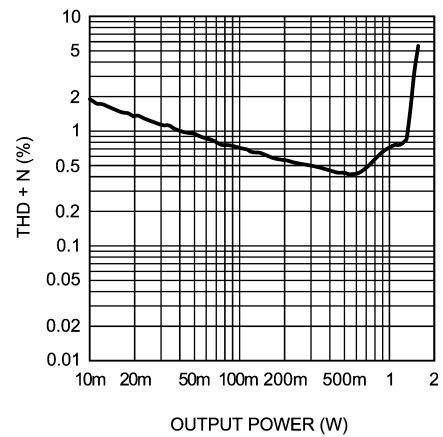

201341P2

AUXOUT THD+N vs Output Voltage
 $AV_{DD} = 3.3V, 0dB\ AUX$
 $f_{OUT} = 1kHz, 5k\Omega$

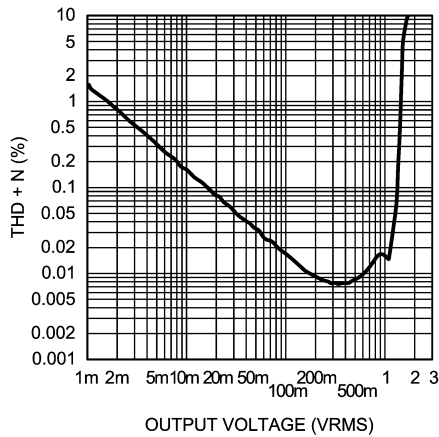

201341L0

AUXOUT THD+N vs Output Voltage
 $AV_{DD} = 5V, 0dB\ AUX$
 $f_{OUT} = 1kHz, 5k\Omega$

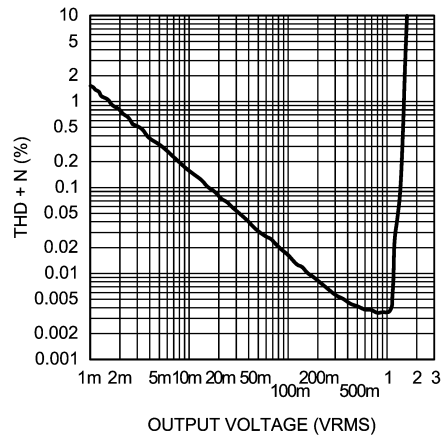

201341L1

13.0 Typical Performance Characteristics (Continued)

AUXOUT THD+N vs Output Voltage

$AV_{DD} = 3.3V, 0dB\ CPI$
 $f_{OUT} = 1kHz, 5k\Omega$

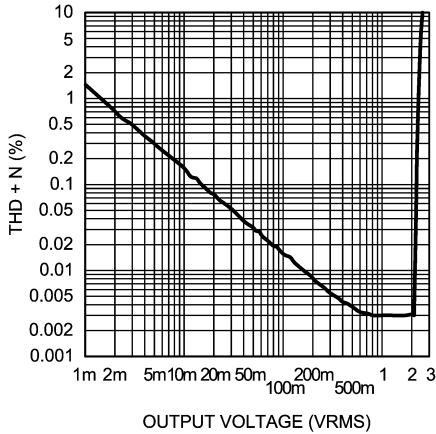

201341L2

AUXOUT THD+N vs Output Voltage

$AV_{DD} = 5V, 0dB\ CPI$
 $f_{OUT} = 1kHz, 5k\Omega$

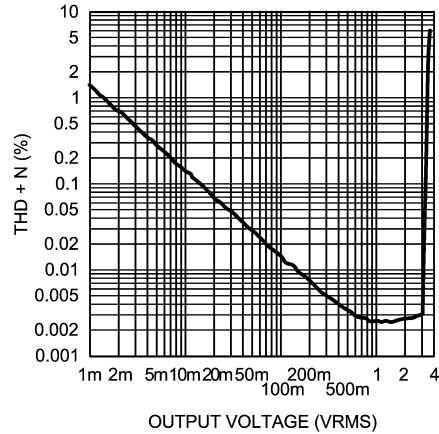

201341L3

AUXOUT THD+N vs Output Voltage

$AV_{DD} = 3.3V, 0dB\ DAC$
 $f_{OUT} = 1kHz, 5k\Omega$

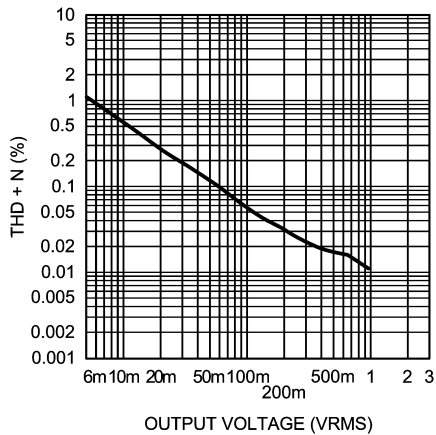

201341L4

AUXOUT THD+N vs Output Voltage

$AV_{DD} = 5V, 0dB\ DAC$
 $f_{OUT} = 1kHz, 5k\Omega$

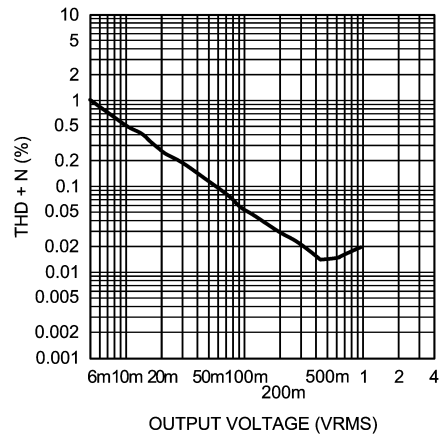

201341L5

AUXOUT THD+N vs Output Voltage

$AV_{DD} = 3.3V, 12dB\ DAC$
 $f_{OUT} = 1kHz, 5k\Omega$

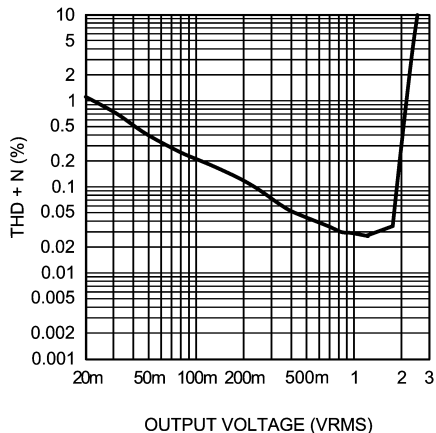

201341L6

AUXOUT THD+N vs Output Voltage

$AV_{DD} = 5V, 12dB\ DAC$
 $f_{OUT} = 1kHz, 5k\Omega$

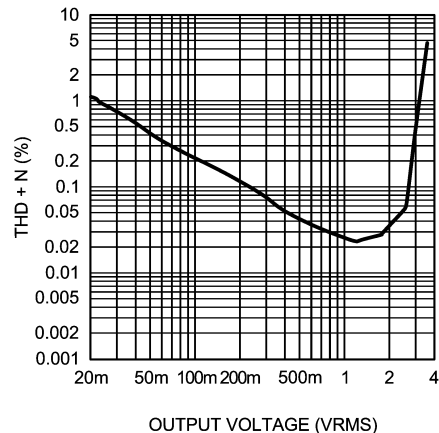

201341L7

13.0 Typical Performance Characteristics (Continued)

CPOUT THD+N vs Output Voltage

$AV_{DD} = 3.3V, 0dB\ AUX$
 $f_{OUT} = 1kHz, 5k\Omega$

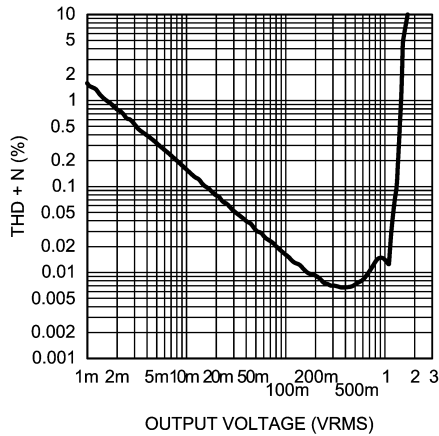

201341L8

CPOUT THD+N vs Output Voltage

$AV_{DD} = 5V, 0dB\ AUX$
 $f_{OUT} = 1kHz, 5k\Omega$

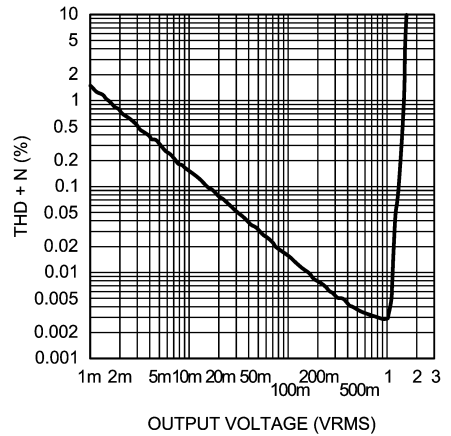

201341L9

CPOUT THD+N vs Output Voltage

$AV_{DD} = 3.3V, 0dB\ DAC$
 $f_{OUT} = 1kHz, 5k\Omega$

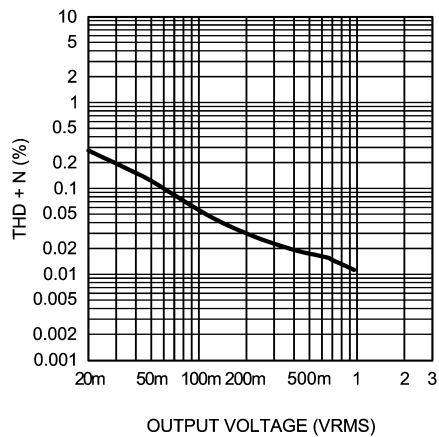

201341M0

CPOUT THD+N vs Output Voltage

$AV_{DD} = 5V, 0dB\ DAC$
 $f_{OUT} = 1kHz, 5k\Omega$

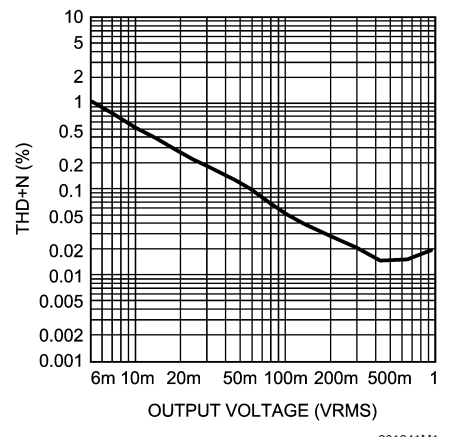

201341M1

CPOUT THD+N vs Output Voltage

$AV_{DD} = 3.3V, 6dB\ MIC$
 $f_{OUT} = 1kHz, 5k\Omega$

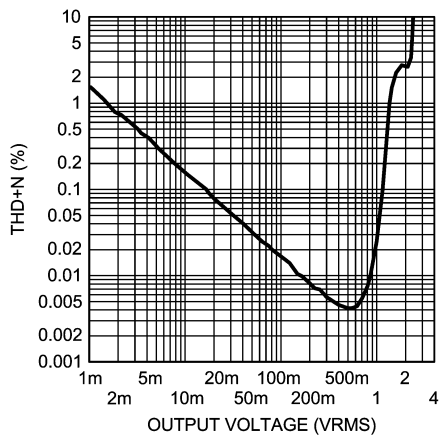

201341M2

CPOUT THD+N vs Output Voltage

$AV_{DD} = 5V, 6dB\ MIC$
 $f_{OUT} = 1kHz, 5k\Omega$

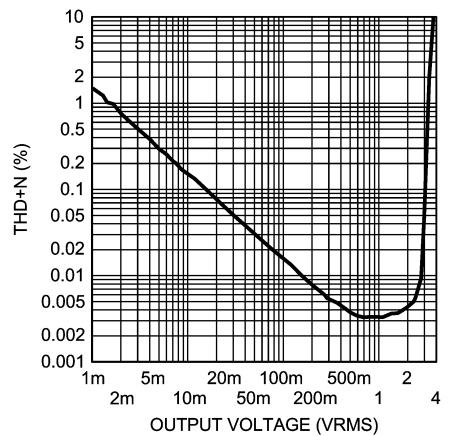

201341M3

13.0 Typical Performance Characteristics (Continued)

CPOUT THD+N vs Output Voltage

$AV_{DD} = 3.3V$, 12dB DAC
 $f_{OUT} = 1kHz$, $5k\Omega$

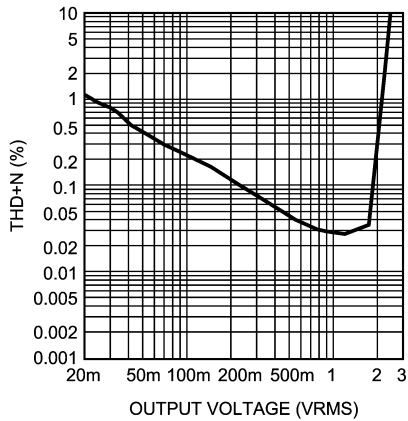

201341M4

CPOUT THD+N vs Output Voltage

$AV_{DD} = 5V$, 12dB DAC
 $f_{OUT} = 1kHz$, $5k\Omega$

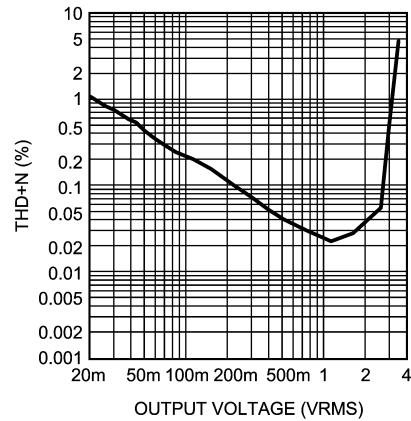

201341M5

CPOUT THD+N vs Output Voltage

$AV_{DD} = 3.3V$, 36dB MIC
 $f_{OUT} = 1kHz$, $5k\Omega$

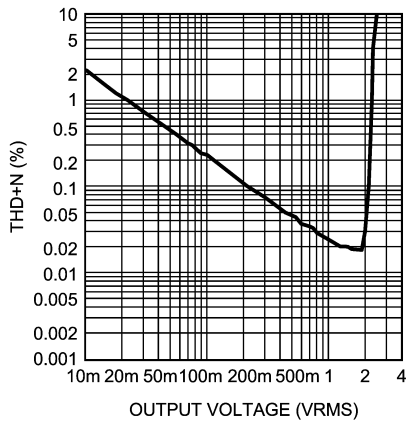

201341M6

CPOUT THD+N vs Output Voltage

$AV_{DD} = 5V$, 36dB MIC
 $f_{OUT} = 1kHz$, $5k\Omega$

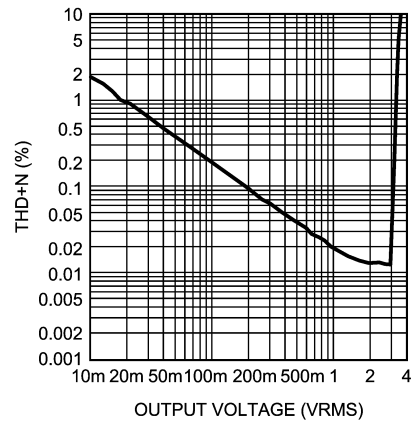

201341M7

Headphone Crosstalk vs Frequency

OCL 1.2V, 0dB AUX, 32Ω

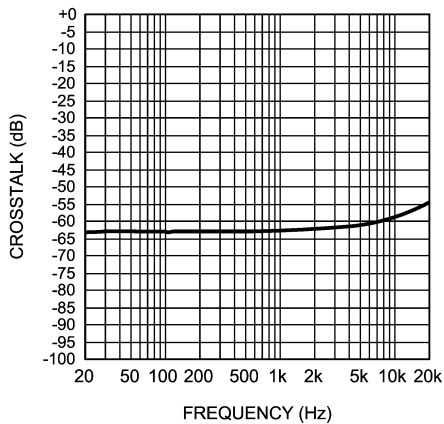

201341M8

Headphone Crosstalk vs Frequency

OCL 1.5V, 0dB AUX, 32Ω

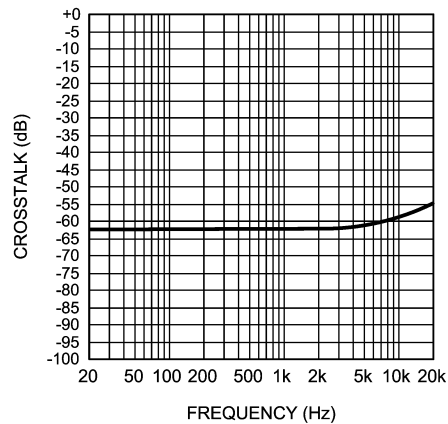

201341M9

13.0 Typical Performance Characteristics (Continued)

Headphone Crosstalk vs Frequency
SE, 0dB AUX, 32Ω

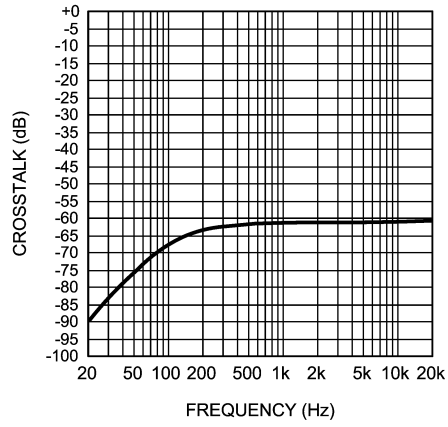

201341N0

14.0 LM4935 Demonstration Board Schematic Diagram

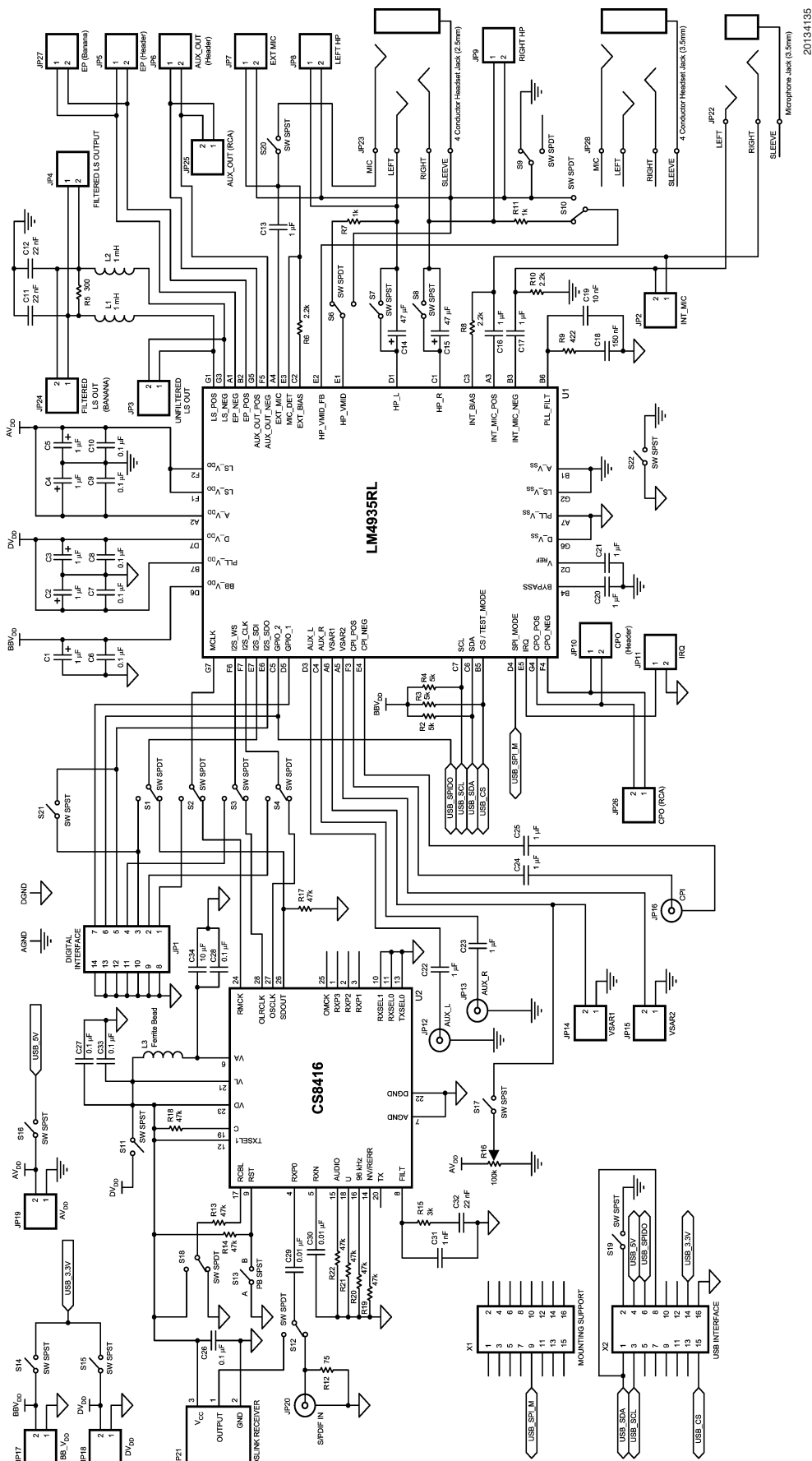

20134135

15.0 Demoboard PCB Layout

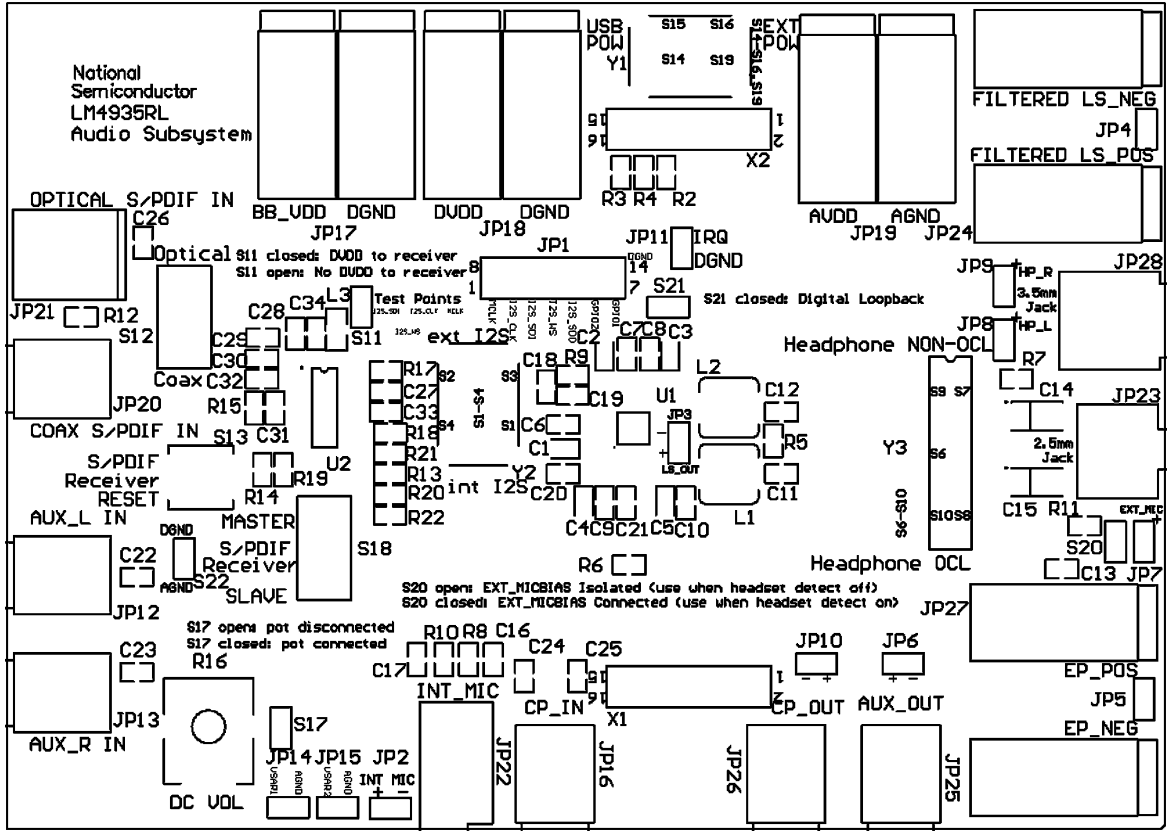

Top Silkscreen

20134132

15.0 Demoboard PCB Layout (Continued)

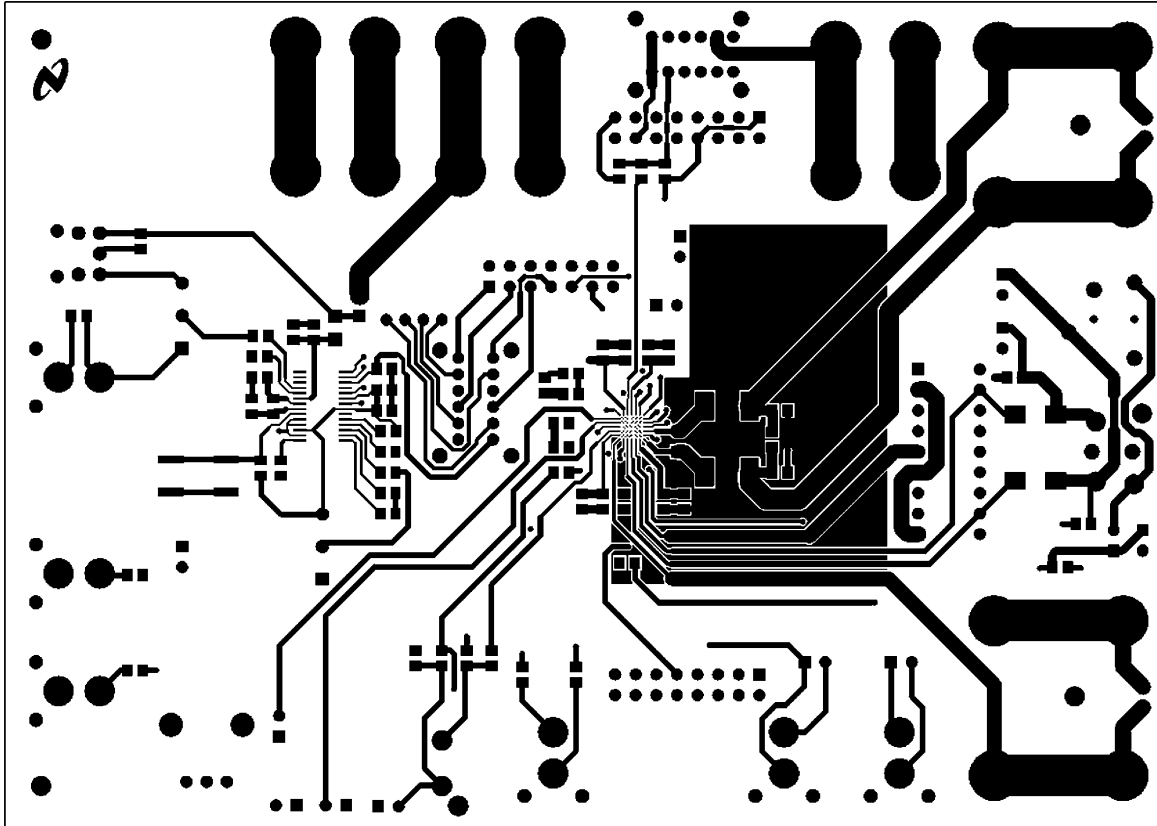

Top Layer

20134131

15.0 Demoboard PCB Layout (Continued)

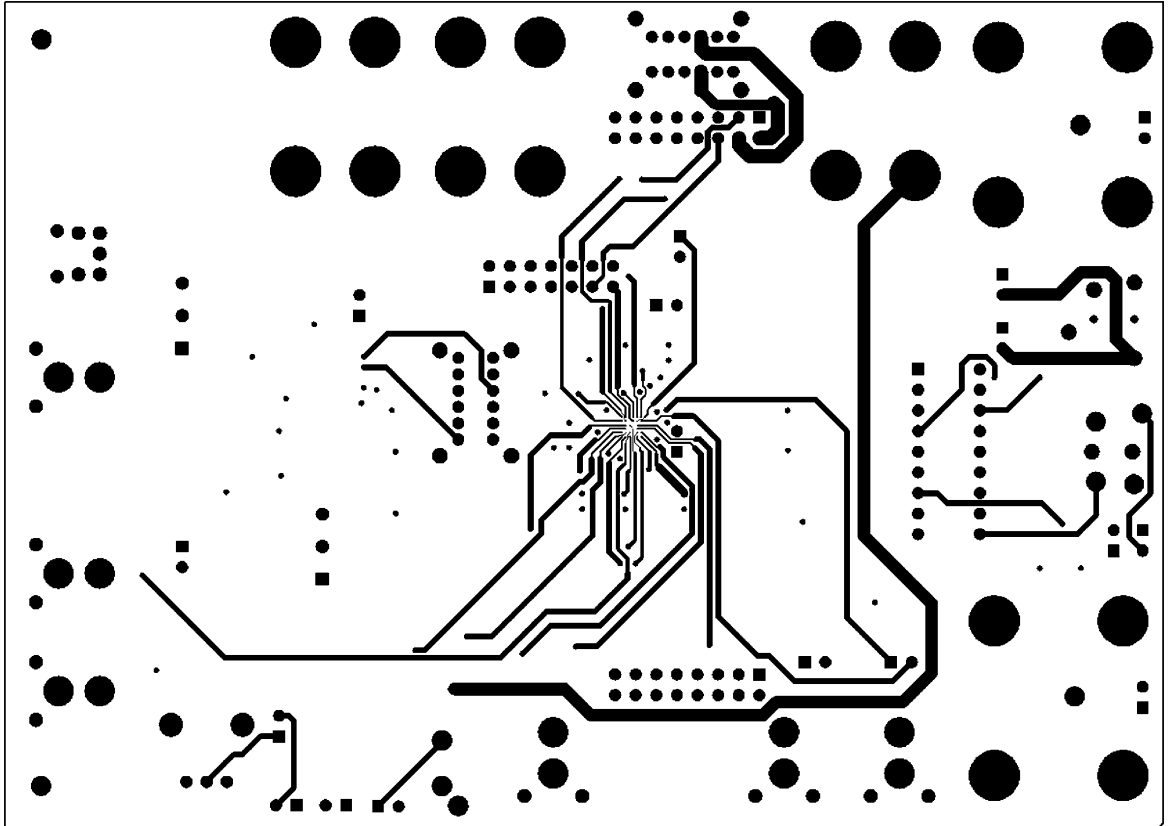

Mid Layer 1

20134129

15.0 Demoboard PCB Layout (Continued)

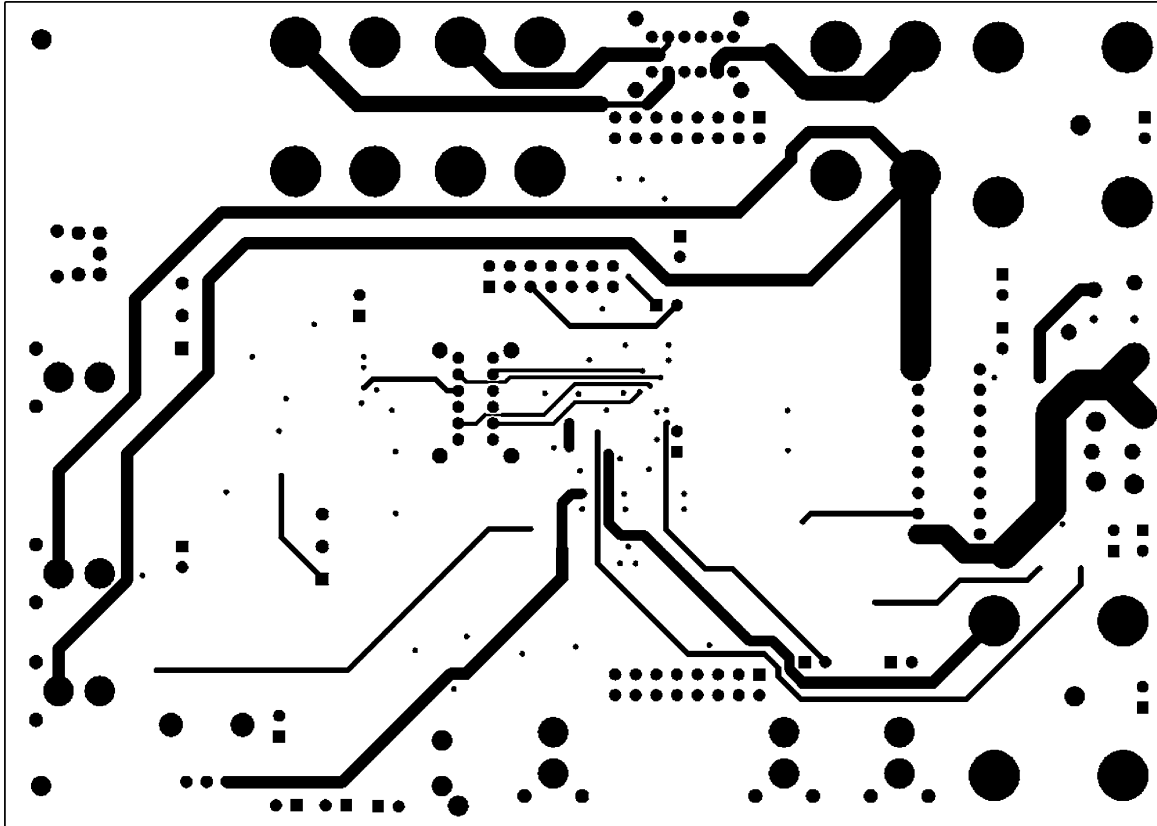

Mid Layer 2

20134130

15.0 Demoboard PCB Layout (Continued)

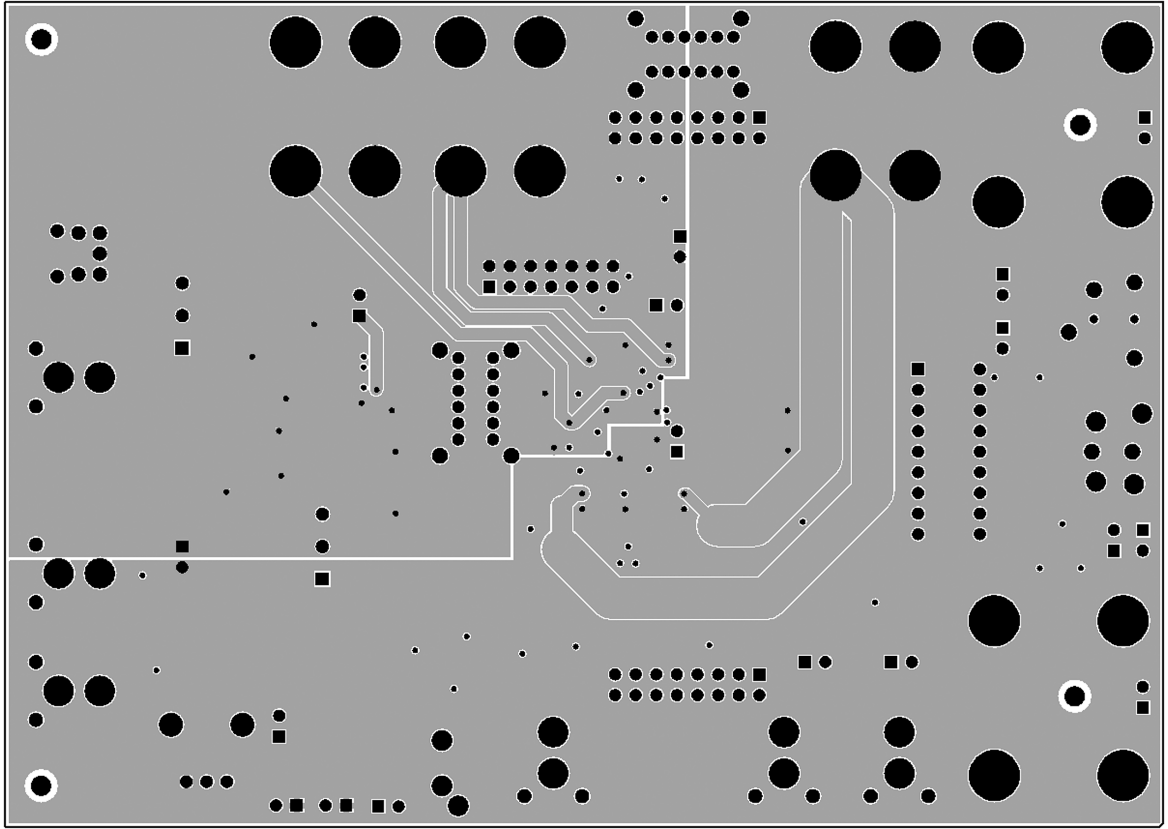

Bottom Layer

20134128

16.0 Product Status Definitions

Datasheet Status	Product Status	Definition
Advance Information	Formative or in Design	This data sheet contains the design specifications for product development. Specifications may change in any manner without notice.
Preliminary	First Production	This data sheet contains preliminary data. Supplementary data will be published at a later date. National Semiconductor Corporation reserves the right to make changes at any time without notice in order to improve design and supply the best possible product.
No Identification Noted	Full Production	This data sheet contains final specifications. National Semiconductor Corporation reserves the right to make changes at any time without notice in order to improve design and supply the best possible product.
Obsolete	Not in Production	This data sheet contains specifications on a product that has been discontinued by National Semiconductor Corporation. The datasheet is printed for reference information only.

National Semiconductor B.V reserves the right to make changes without notice to any products herein to improve reliability, function or design. National does not assume any liability arising out of the application or use of any product or circuit described herein; neither does it convey any license under its patent rights, nor the right of others.

17.0 Revision History

Rev	Date	Description
1.0	5/11/05	Filled in the actual limits (for TBDs) under Limit and edited few Typical values, all under the EC table. Edits from Alvin F.
1.1	7/29/05	Input more edits. Replaced the correct boards. Replaced the Schematic Diagram (pg 60).
1.2	9/8/05	Added the 1st set of Typ Perf curves.
1.3	9/21/05	Added a couple of tables.
1.4	9/30/05	Input text edits.
1.5	10/5/05	Input more edits.
1.6	10/11/05	More edits.
1.7	10/12/05	First D/S WEB release.
1.8	10/14/5	Input more text edits after the 1st released.
1.9	10/17/05	Input some text edits, then re-released D/S to the WEB.
2.0	10/18/05	More text edits. Also used graphic 20134107 back.
2.1	12/19/05	Added the RL package
2.2	12/20/05	Deleted the WL pkg and replaced with the RL pkg.
2.3	1/19/06	Fixed 20134132(top silkscreen) and 35 (schem layout) plus few text edits.
2.4	1/25/06	Fixed the value on X3 (mktg outline). Re-released D/S to the WEB.

18.0 Physical Dimensions inches (millimeters) unless otherwise noted

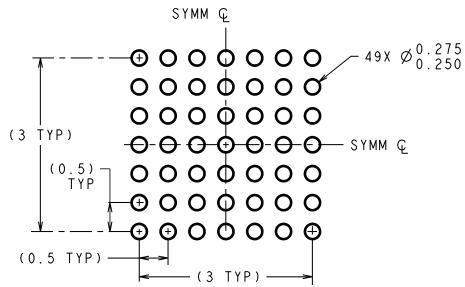

LAND PATTERN RECOMMENDATION

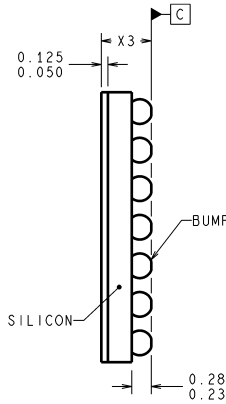
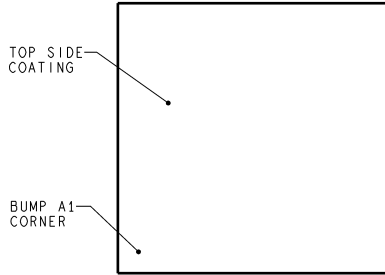

DIMENSIONS ARE IN MILLIMETERS
DIMENSIONS IN () FOR REFERENCE ONLY

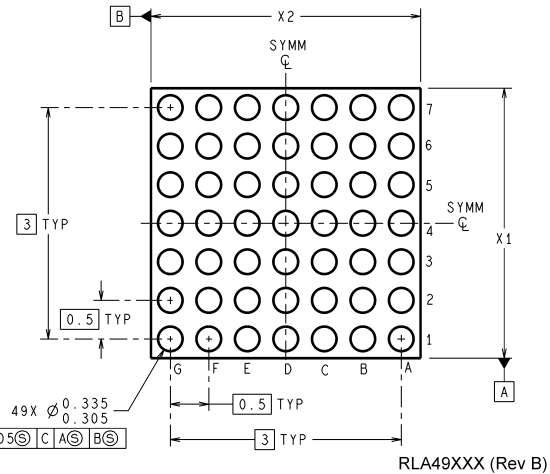

RLA49XXX (Rev B)

49 Bump micro SMDxt Package Order Number LM4935RL

Dimensions: X1 = 3.924±0.03mm, X2 = 3.924±0.03mm, X3 = 0.650±0.75mm
NS Package Number RLA49UUA

National does not assume any responsibility for use of any circuitry described, no circuit patent licenses are implied and National reserves the right at any time without notice to change said circuitry and specifications.

For the most current product information visit us at www.national.com.

LIFE SUPPORT POLICY

NATIONAL'S PRODUCTS ARE NOT AUTHORIZED FOR USE AS CRITICAL COMPONENTS IN LIFE SUPPORT DEVICES OR SYSTEMS WITHOUT THE EXPRESS WRITTEN APPROVAL OF THE PRESIDENT AND GENERAL COUNSEL OF NATIONAL SEMICONDUCTOR CORPORATION. As used herein:

- Life support devices or systems are devices or systems which, (a) are intended for surgical implant into the body, or (b) support or sustain life, and whose failure to perform when properly used in accordance with instructions for use provided in the labeling, can be reasonably expected to result in a significant injury to the user.
- A critical component is any component of a life support device or system whose failure to perform can be reasonably expected to cause the failure of the life support device or system, or to affect its safety or effectiveness.

BANNED SUBSTANCE COMPLIANCE

National Semiconductor manufactures products and uses packing materials that meet the provisions of the Customer Products Stewardship Specification (CSP-9-111C2) and the Banned Substances and Materials of Interest Specification (CSP-9-111S2) and contain no "Banned Substances" as defined in CSP-9-111S2.

Leadfree products are RoHS compliant.



National Semiconductor
Americas Customer
Support Center
Email: new.feedback@nsc.com
Tel: 1-800-272-9959

www.national.com

National Semiconductor
Europe Customer Support Center
Fax: +49 (0) 180-530 85 86
Email: europe.support@nsc.com
Deutsch Tel: +49 (0) 69 9508 6208
English Tel: +44 (0) 870 24 0 2171
Français Tel: +33 (0) 1 41 91 8790

National Semiconductor
Asia Pacific Customer
Support Center
Email: ap.support@nsc.com

National Semiconductor
Japan Customer Support Center
Fax: 81-3-5639-7507
Email: jpn.feedback@nsc.com
Tel: 81-3-5639-7560