

LM6165/LM6265/LM6365 High Speed Operational Amplifier

General Description

The LM6165 family of high-speed amplifiers exhibits an excellent speed-power product in delivering 300 V/ μ s and 725 MHz GBW (stable for gains as low as +25) with only 5 mA of supply current. Further power savings and application convenience are possible by taking advantage of the wide dynamic range in operating supply voltage which extends all the way down to +5V.

These amplifiers are built with National's VIPTM (Vertically Integrated PNP) process which produces fast PNP transistors that are true complements to the already fast NPN devices. This advanced junction-isolated process delivers high speed performance without the need for complex and expensive dielectric isolation.

Features

- High slew rate 300 V/ μ s
- High GBW product 725 MHz
- Low supply current 5 mA
- Fast settling 80 ns to 0.1%
- Low differential gain <0.1%
- Low differential phase <0.1°
- Wide supply range 4.75V to 32V
- Stable with unlimited capacitive load

Applications

- Video amplifier
- Wide-bandwidth signal conditioning
- Radar
- Sonar

Connection Diagrams

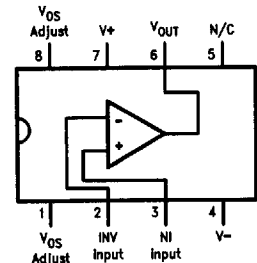
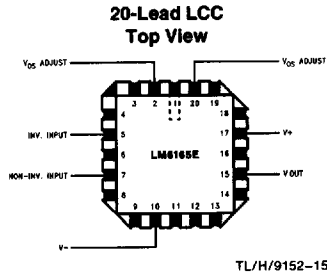
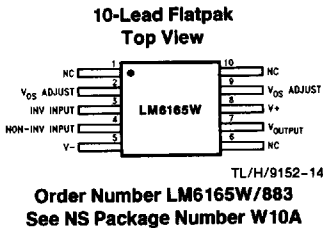

Order Number LM6165J/883
See NS Package Number J08A

Order Number LM6365M
See NS Package Number M08A

Order Number LM6265N or LM6365N
See NS Package Number N08E

Temperature Range			Package	NSC Drawing
Military -55°C ≤ TA ≤ +125°C	Industrial -25°C ≤ TA ≤ +85°C	Commercial 0°C ≤ TA ≤ +70°C		
	LM6265N	LM6365N	8-Pin Molded DIP	N08E
LM6165J/883 5962-8962501PA			8-Pin Ceramic DIP	J08A
		LM6365M	8-Pin Molded Surface Mt.	M08A
LM6165E/883 5962-89625012A			20-Lead LCC	E20A
LM6165W883 5962-8962501HA			10-Pin Ceramic Flatpak	W10A

Absolute Maximum Ratings

If Military/Aerospace specified devices are required, please contact the National Semiconductor Sales Office/Distributors for availability and specifications.

Supply Voltage ($V^+ - V^-$)	36V
Differential Input Voltage (Note 6)	$\pm 8V$
Common-Mode Voltage Range (Note 10)	$(V^+ - 0.7V)$ to $(V^- + 0.7V)$
Output Short Circuit to GND (Note 1)	Continuous
Soldering Information	
Dual-In-Line Package (N, J)	
Soldering (10 sec.)	260°C
Small Outline Package (M)	
Vapor Phase (60 sec.)	215°C
Infrared (15 sec.)	220°C

See AN-450 "Surface Mounting Methods and Their Effect on Product Reliability" for other methods of soldering surface mount devices.

Storage Temp Range	-65°C to $+150^\circ\text{C}$
Max Junction Temperature (Note 2)	150°C
ESD Tolerance (Notes 6 and 7)	$\pm 700V$

Operating Ratings

Temperature Range (Note 2)	
LM6165, LM6165J/883	$-55^\circ\text{C} \leq T_J \leq +125^\circ\text{C}$
LM6265	$-25^\circ\text{C} \leq T_J \leq +85^\circ\text{C}$
LM6365	$0^\circ\text{C} \leq T_J \leq +70^\circ\text{C}$
Supply Voltage Range	4.75V to 32V

DC Electrical Characteristics

The following specifications apply for Supply Voltage = $\pm 15V$, $V_{CM} = 0$, $R_L \geq 100\text{ k}\Omega$ and $R_S = 50\Omega$ unless otherwise noted. **Boldface** limits apply for $T_A = T_J = T_{MIN}$ to T_{MAX} ; all other limits $T_A = T_J = 25^\circ\text{C}$.

Symbol	Parameter	Conditions	Typ	LM6165	LM6265	LM6365	Units
				Limit (Notes 3, 11)	Limit (Note 3)	Limit (Note 3)	
V_{OS}	Input Offset Voltage		1	3 4	3 4	6 7	mV Max
V_{OS} Drift	Input Offset Voltage Average Drift		3				$\mu\text{V}/^\circ\text{C}$
I_b	Input Bias Current		2.5	3 6	3 5	5 6	μA Max
I_{OS}	Input Offset Current		150	350 800	350 600	1500 1900	nA Max
I_{OS} Drift	Input Offset Current Average Drift		0.3				nA/ $^\circ\text{C}$
R_{IN}	Input Resistance	Differential	20				k Ω
C_{IN}	Input Capacitance		6.0				pF
A_{VOL}	Large Signal Voltage Gain (Note 9)	$V_{OUT} = \pm 10V$, $R_L = 2\text{ k}\Omega$	10.5	7.5 5.0	7.5 6.0	5.5 5.0	V/mV Min
		$R_L = 10\text{ k}\Omega$	38				
V_{CM}	Input Common-Mode Voltage Range	Supply = $\pm 15V$	+14.0 -13.6	+13.9 +13.8 -13.4 -13.2	+13.9 +13.8 -13.4 -13.2	+13.8 +13.7 -13.3 -13.2	V Min V Min
		Supply = +5V (Note 4)	4.0 1.4	3.9 3.8 1.6 1.8	3.9 3.8 1.6 1.8	3.8 3.7 1.7 1.8	V Min V Max
CMRR	Common-Mode Rejection Ratio	$-10V \leq V_{CM} \leq +10V$	102	88 82	88 84	80 78	dB Min
PSRR	Power Supply Rejection Ratio	$\pm 10V \leq V_{\pm} \leq \pm 16V$	104	88 82	88 84	80 78	dB Min
V_O	Output Voltage Swing	Supply = $\pm 15V$, $R_L = 2\text{ k}\Omega$	+14.2 -13.4	+13.5 +13.3 -13.0 -12.7	+13.5 +13.3 -13.0 -12.8	+13.4 +13.3 -12.9 -12.8	V Min V Min

DC Electrical Characteristics (Continued)

The following specifications apply for Supply Voltage = $\pm 15V$, $V_{CM} = 0$, $R_L \geq 100\text{ k}\Omega$ and $R_S = 50\Omega$ unless otherwise noted. **Boldface** limits apply for $T_A = T_J = T_{MIN}$ to T_{MAX} ; all other limits $T_A = T_J = 25^\circ\text{C}$.

Symbol	Parameter	Conditions	Typ	LM6165	LM6265	LM6365	Units
				Limit (Notes 3, 11)	Limit (Note 3)	Limit (Note 3)	
V_O (Continued)	Output Voltage Swing (Continued)	Supply = +5V $R_L = 2\text{ k}\Omega$ (Note 4)	4.2	3.5 3.3	3.5 3.3	3.4 3.3	V Min
			1.3	1.7 2.0	1.7 1.9	1.8 1.9	V Max
	Output Short Circuit Current	Source	65	30 20	30 25	30 25	mA Min
		Sink	65	30 20	30 25	30 25	mA Min
I_S	Supply Current		5.0	6.5 6.8	6.5 6.7	6.8 6.9	mA Max

AC Electrical Characteristics

The following specifications apply for Supply Voltage = $\pm 15V$, $V_{CM} = 0$, $R_L \geq 100\text{ k}\Omega$ and $R_S = 50\Omega$ unless otherwise noted. **Boldface** limits apply for $T_A = T_J = T_{MIN}$ to T_{MAX} ; all other limits $T_A = T_J = 25^\circ\text{C}$. (Note 5)

Symbol	Parameter	Conditions	Typ	LM6165	LM6265	LM6365	Units
				Limit (Notes 3, 11)	Limit (Note 3)	Limit (Note 3)	
GBW	Gain Bandwidth	F = 20 MHz	725	575 350	575	500	MHz Min
	Product	Supply = $\pm 5V$	500				
SR	Slew Rate	$A_V = +25$ (Note 8)	300	200 180	200	200	V/ μs Min
		Supply = $\pm 5V$	200				
PBW	Power Bandwidth Product	$V_{OUT} = 20\text{ V}_{PP}$	4.5				MHz
t_S	Settling Time	10V Step to 0.1% $A_V = -25$, $R_L = 2\text{ k}\Omega$	80				ns
ϕ_m	Phase Margin	$A_V = +25$	45				Deg
A_D	Differential Gain	NTSC, $A_V = +25$	<0.1				%
ϕ_D	Differential Phase	NTSC, $A_V = +25$	<0.1				Deg
e_{np-p}	Input Noise Voltage	F = 10 kHz	5				nV/ $\sqrt{\text{Hz}}$
i_{np-p}	Input Noise Current	F = 10 kHz	1.5				pA/ $\sqrt{\text{Hz}}$

Note 1: Continuous short-circuit operation at elevated ambient temperature can result in exceeding the maximum allowed junction temperature of 150°C .

Note 2: The typical junction-to-ambient thermal resistance of the molded plastic DIP (N) is $105^\circ\text{C}/\text{Watt}$, and the molded plastic SO (M) package is $155^\circ\text{C}/\text{Watt}$, and the cerdip (J) package is $125^\circ\text{C}/\text{Watt}$. All numbers apply for packages soldered directly into a printed circuit board.

Note 3: All limits guaranteed by testing or correlation.

Note 4: For single supply operation, the following conditions apply: $V_+ = 5V$, $V_- = 0V$, $V_{CM} = 2.5C$, $V_{OUT} = 2.5V$. Pin 1 & Pin 8 (V_{OS} Adjust) are each connected to Pin 4 (V_-) to realize maximum output swing. This connection will degrade V_{OS} .

Note 5: $C_L \leq 5\text{ pF}$.

Note 6: In order to achieve optimum AC performance, the input stage was designed without protective clamps. Exceeding the maximum differential input voltage results in reverse breakdown of the base-emitter junction of one of the input transistors and probable degradation of the input parameters (especially V_{OS} , I_{OS} , and Noise).

Note 7: The average voltage that the weakest pin combinations (those involving Pin 2 or Pin 3) can withstand and still conform to the datasheet limits. The test circuit used consists of the human body model of 100 pF in series with 1500Ω .

Note 8: $V_{IN} = 0.8V$ step. For supply = $\pm 5V$, $V_{IN} = 0.2V$ step.

Note 9: Voltage Gain is the total output swing (20V) divided by the input signal required to produce that swing.

Note 10: The voltage between V_+ and either input pin must not exceed 36V.

Note 11: A military RETS electrical test specification is available on request. At the time of printing, the LM6165J/883 RETS spec complied with the **Boldface** limits in this column. The LM6165J/883 may also be procured as Standard Military Drawing #5962-8962501PA.

Typical Performance Characteristics $R_L = 10\text{ k}\Omega$, $T_A = 25^\circ\text{C}$ unless otherwise specified

Supply Current vs Supply Voltage

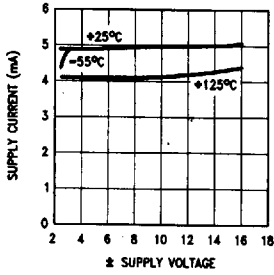

Common-Mode Rejection Ratio

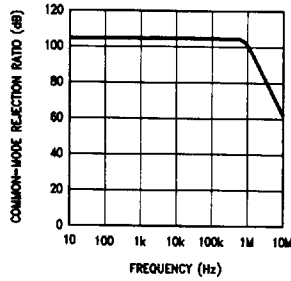

Power Supply Rejection Ratio

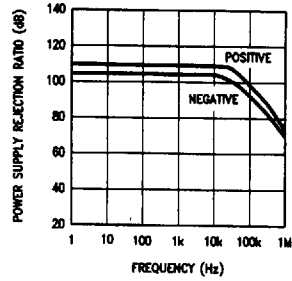

Gain-Bandwidth Product

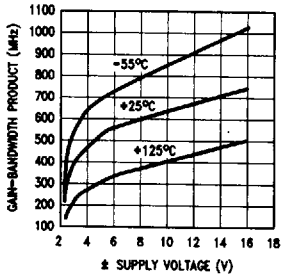

Propagation Delay, Rise and Fall Times

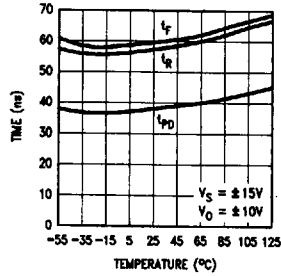

Gain-Bandwidth Product vs Load Capacitance

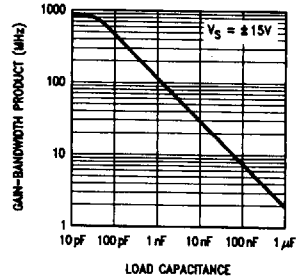

Slew Rate vs Load Capacitance

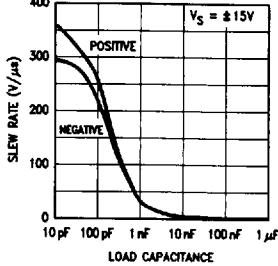

Overshoot vs Capacitive Load

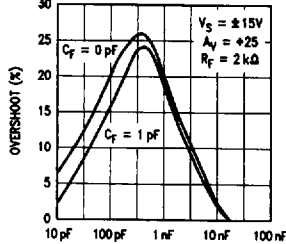

Slew Rate

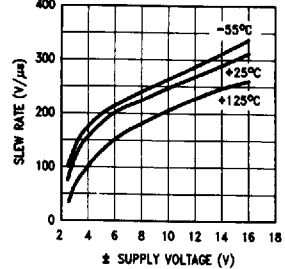

Output Impedance (Open-Loop)

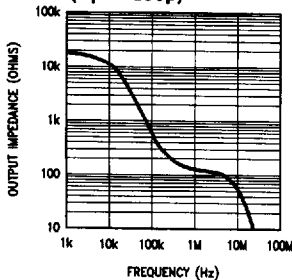

Gain vs Supply Voltage

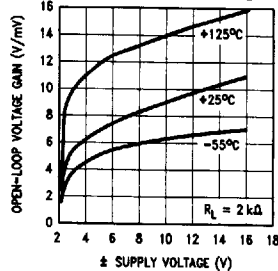

Typical Performance Characteristics (Continued)

$R_L = 10\text{ k}\Omega$, $T_A = 25^\circ\text{C}$ unless otherwise specified

Differential Gain (Note)

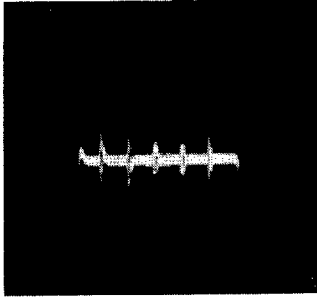

TL/H/9152-6

Differential Phase (Note)

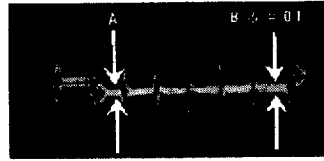

TL/H/9152-7

Note: Differential gain and differential phase measured for four series LM6365 op amps configured with gain of +25 (each output attenuated by 96%), in series with an LM6321 buffer. Error added by LM6321 is negligible. Test performed using Tektronix Type 520 NTSC test system.

Step Response; $A_v = +25$

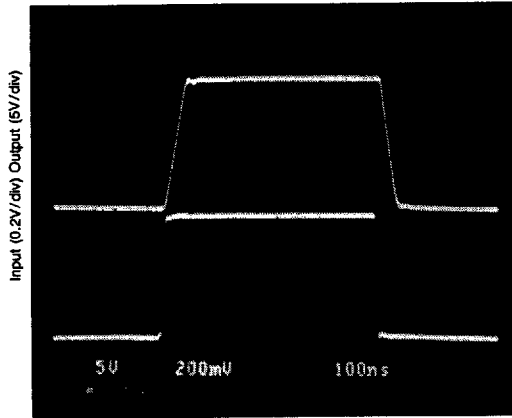

TL/H/9152-1

TIME (50 ns/div)

Input Noise Voltage

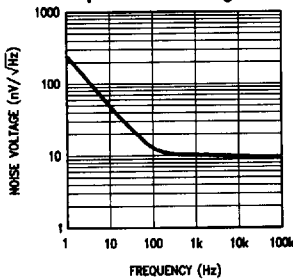

Input Noise Current

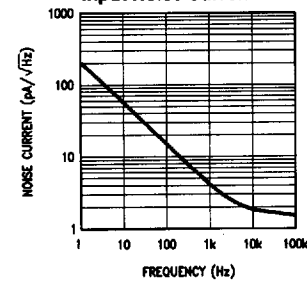

Power Bandwidth

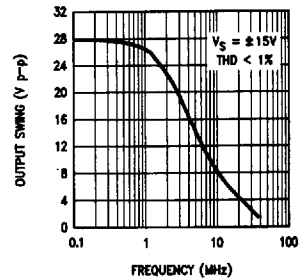

TL/H/9152-9

Typical Performance Characteristics (Continued)

$R_L = 10\text{ k}\Omega$, $T_A = 25^\circ\text{C}$ unless otherwise specified

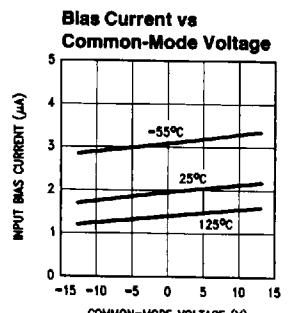
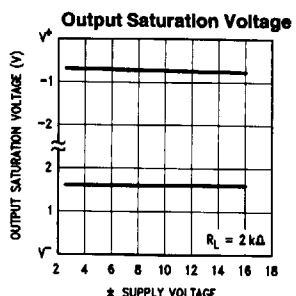
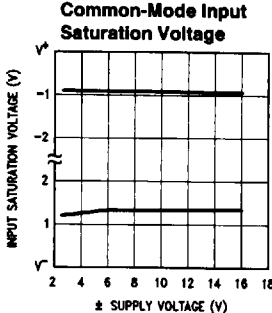
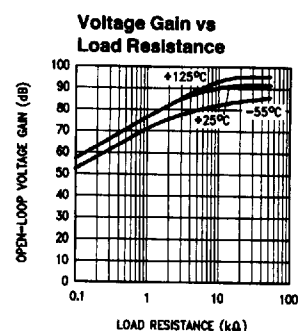
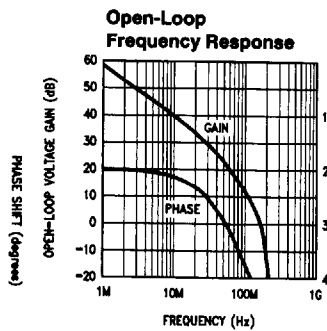
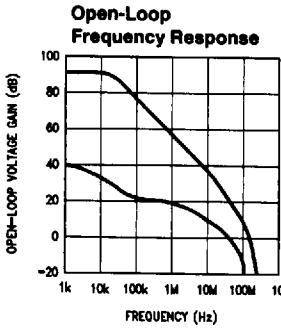

TL/H/9152-10

Simplified Schematic

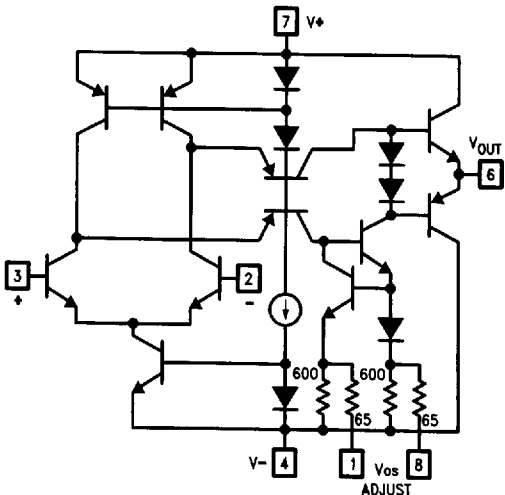

TL/H/9152-3

Applications Tips

The LM6365 is stable for gains of 25 or greater. The LM6361 and LM6364, specified in separate datasheets, are compensated versions of the LM6365. The LM6361 is unity-gain stable, while the LM6364 is stable for gains as low as 5. The LM6361, and LM6364 have the same high slew rate as the LM6365, typically 300 V/ μ s.

To use the LM6365 for gains less than 25, a series resistor-capacitor network should be added between the input pins (as shown in the Typical Applications, Noise Gain Compensation) so that the high-frequency noise gain rises to at least 25.

Power supply bypassing will improve stability and transient response of the LM6365, and is recommended for every design. 0.01 μ F to 0.1 μ F ceramic capacitors should be

used (from each supply "rail" to ground); an additional 2.2 μ F to 10 μ F (tantalum) may be required for extra noise reduction.

Keep all leads short to reduce stray capacitance and lead inductance, and make sure ground paths are low-impedance, especially where heavier currents will be flowing. Stray capacitance in the circuit layout can cause signal coupling between adjacent nodes, and can cause circuit gain to unintentionally vary with frequency.

Breadboarded circuits will work best if they are built using generic PC boards with a good ground plane. If the op amps are used with sockets, as opposed to being soldered into the circuit, the additional input capacitance may degrade circuit performance.

Typical Applications

Offset Voltage Adjustment

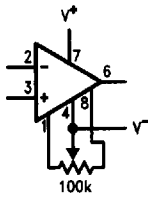

TL/H/9152-11

Noise-Gain Compensation

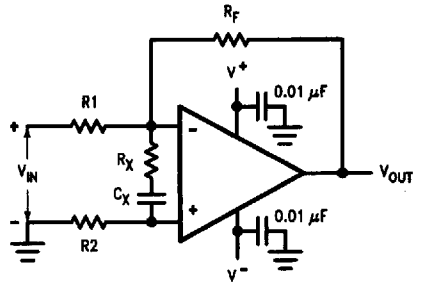

TL/H/9152-12

$$R_x C_x \geq 1/(2\pi \cdot 25 \text{ MHz})$$

$$[R_1 + R_f (1 + R_1/R_2)] = 25 R_x$$

1 MHz Voltage-to-Frequency Converter
($f_{OUT} = 1 \text{ MHz}$ for $V_{IN} = 10 \text{ V}$)

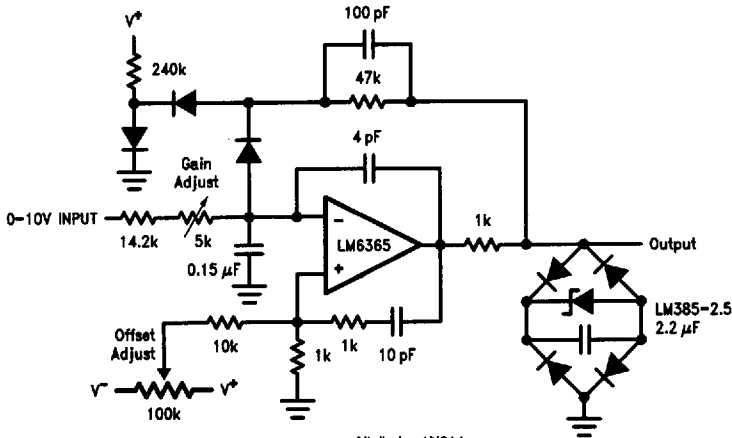

All diodes 1N814

TL/H/9152-13