

High Speed PWM Controller

FEATURES

- Compatible with Voltage or Current-Mode Topologies
- Practical Operation @ Switching Frequencies to 1.0MHz
- 50ns Propagation Delay to Output
- High Current Totem Pole Output (1.5A peak)
- Wide Bandwidth Error Amplifier
- Fully Latched Logic with Double Pulse Suppression
- Pulse-by-Pulse Current Limiting
- Soft Start/Max. Duty Cycle Control
- Under-Voltage Lockout with Hysteresis
- Low Start Up Current (1.1mA)
- Trimmed Bandgap Reference (5.1V \pm 1%)

DESCRIPTION

The UC1823 family of PWM control ICs is optimized for high frequency switched mode power supply applications. Particular care was given to minimizing propagation delays through the comparators and logic circuitry while maximizing bandwidth and slew rate of the error amplifier. This controller is designed for use in either current-mode or voltage-mode systems with the capability for input voltage feed-forward.

Protection circuitry includes a current limit comparator, a TTL compatible shutdown port, and a soft start pin which will double as a maximum duty cycle clamp. The logic is fully latched to provide jitter free operation and prohibit multiple pulses at the output. An under-voltage lockout section with 800mV of hysteresis assures low start up current. During under-voltage lockout, the output is high impedance. The current limit reference (pin 11) is a DC input voltage to the current limit comparator. Consult specifications for details.

These devices feature a totem pole output designed to source and sink high peak currents from capacitive loads, such as the gate of a power MOSFET. The on state is defined as a high level.

ABSOLUTE MAXIMUM RATINGS

Supply Voltage (Pins 15, 13)	30V
Output Current, Source or Sink (Pin14)	
DC	0.5A
Pulse (0.5 μ s)	2.0A
Analog Inputs (Pins 1, 2, 7, 8, 9, 11)	-0.3V to +6V
Clock Output Current (Pin 4)	-5mA
Error Amplifier Output Current (Pin 3)	5mA
Soft Start Sink Current (Pin 8)	20mA

Oscillator Charging Current (Pin 5)	-5mA
Power Dissipation at T _A = 60 °C	1W
Storage Temperature Range	-65°C to +150°C
Lead Temperature (Soldering, 10 seconds)	300°C

Note: All voltages are with respect to ground, Pin 10.

Currents are positive into the specified terminal.

Consult Packaging Section of Databook for thermal limitations

BLOCK DIAGRAM

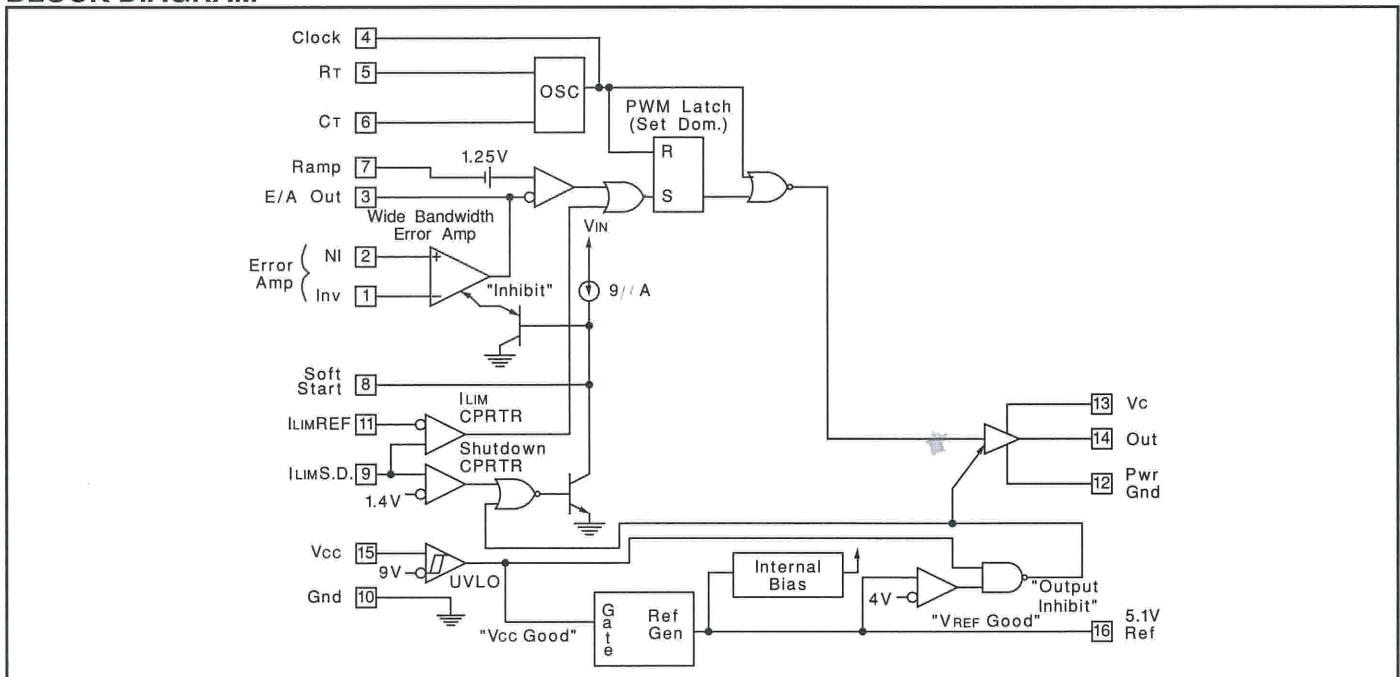

CONNECTION DIAGRAMS

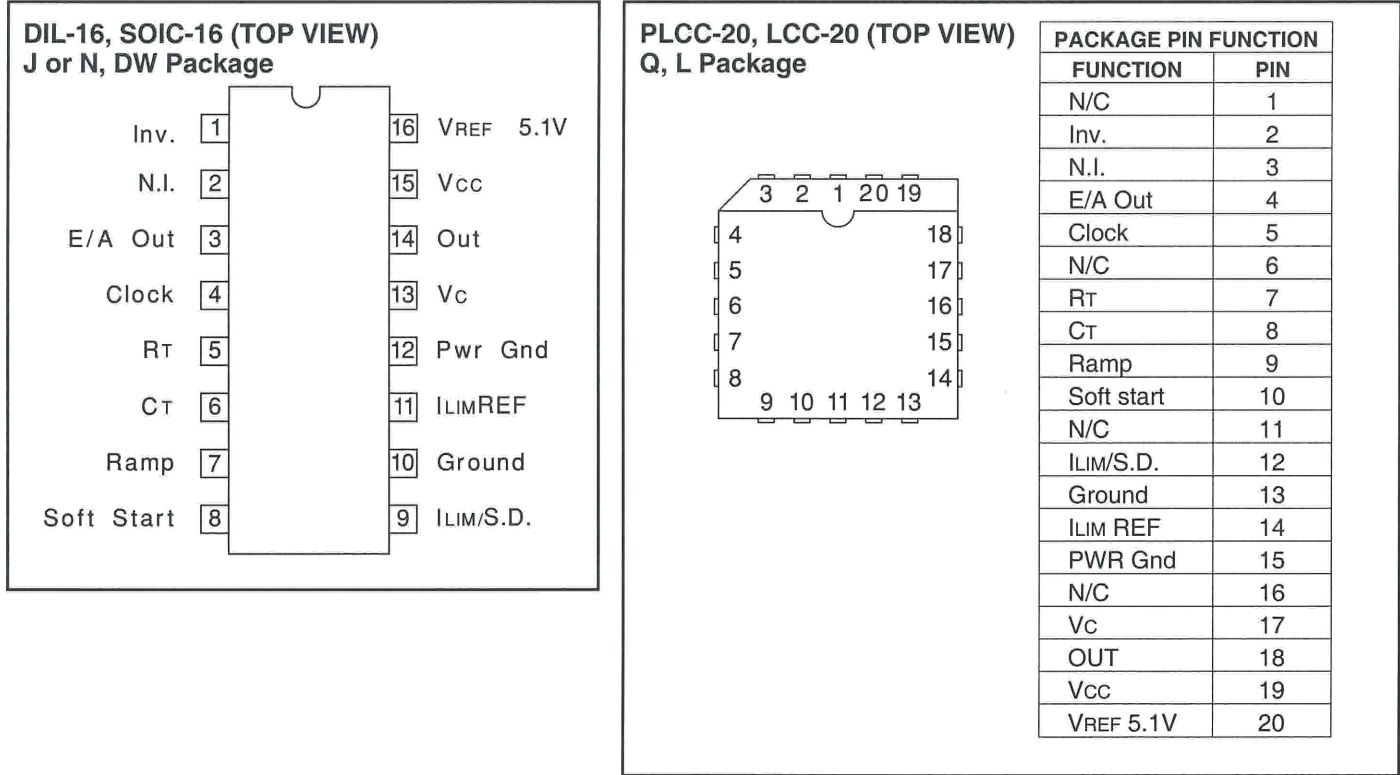

THERMAL PACKAGING INFORMATION

PACKAGE	θ_{JA}	θ_{JC}
J-16	80 - 120	28 (Note2)
N-16	90 (Note1)	45
DW-16	45 - 90 (Note1)	25
PLCC-20 Q Package	43 - 75 (Note1)	34
LCC-20 LPackage	70 - 80	20 (Note2)

Note 1. Specified θ_{JA} (junction to ambient) is for devices mounted to 5-in-2 FR4 PC board with one ounce copper where noted. When resistance range is given, lower values are for 5-in-2 aluminum PC board. Test PWB was 0.062 in thick and typically used 0.635 mm trace widths for power pkgs and 1.3 mm trace widths for non-power pkgs with a 100 x 100 mil probe land area at the end of each trace.

Note 2. θ_{JC} data values stated were derived from MIL-STD-1835B. MIL-STD-1835B states that "The baseline values shown are worst case (mean + 2s) for a 60 x 60 mil microcircuit device silicon die and applicable for devices with die sizes up to 14400 square mils. For device die sizes greater than 14400 square mils use the following values; dual-in-line, 11°C/W; flat pack, 10°C/W; pin grid array, 10°C/W"

ELECTRICAL CHARACTERISTICS: Unless otherwise noted, these specifications apply for $R_T = 3.65k$, $C_T = 1nF$, $V_{CC} = 15V$, $0^\circ C < T_A < +70^\circ C$ for the UC3823, $-25^\circ C < T_A < +85^\circ C$ for the UC2823, and $-55^\circ C < T_A < +125^\circ C$ for the UC1823, $T_A = T_J$.

PARAMETER	TEST CONDITIONS	UC1823 UC2823			UC3823			UNITS
		MIN	TYP	MAX	MIN	TYP	MAX	
Reference Section								
Output Voltage	$T_J = 25^\circ C$, $I_O = 1mA$	5.05	5.10	5.15	5.00	5.10	5.20	V
Line Regulation	$10 < V_{CC} < 30V$		2	20		2	20	mV
Load Regulation	$1 < I_O < 10mA$		5	20		5	20	mV
Temperature Stability*	$T_{MIN} < T_A < T_{MAX}$		0.2	0.4		0.2	0.4	mV/ $^\circ C$
Total Output Variation*	Line, Load, Temp.	5.00		5.20	4.95		5.25	
Output Noise Voltage*	$10Hz < f < 10kHz$		50			50		μV
Long Term Stability*	$T_J = 125^\circ C$, 1000 hrs.		5	25		5	25	mV
Short Circuit Current	$V_{REF} = 0V$	-15	-50	-100	-15	-50	-100	mA
Oscillator Section								
Initial Accuracy*	$T_J = 25^\circ C$	360	400	440	360	400	440	kHz
Voltage Stability*	$10 < V_{CC} < 30V$		0.2	2		0.2	2	%
Temperature Stability*	$T_{MIN} < T_A < T_{MAX}$ (UC1823)		12					%
	$T_{MIN} < T_A < T_{MAX}$ (UC2823)		5					%
	$T_{MIN} < T_A < T_{MAX}$ (UC3823)					5		%
Total Variation*	Line, Temp.	340		460	340		460	kHz
Clock Out High		3.9	4.5		3.9	4.5		V
Clock Out Low			2.3	2.9		2.3	2.9	V
Ramp Peak*		2.6	2.8	3.0	2.6	2.8	3.0	V
Ramp Valley*		0.7	1.0	1.25	0.7	1.0	1.25	V
Error Amplifier Section								
Input Offset Voltage				10			15	mV
Input Bias Current			0.6	3		0.6	3	μA
Input Offset Current			0.1	1		0.1	1	μA
Open Loop Gain	$1 < V_O < 4V$	60	95		60	95		dB
CMRR	$1.5 < V_{CM} < 5.5V$	75	95		75	95		dB
PSRR	$10 < V_{CC} < 30V$	85	110		85	110		dB
Output Sink Current	$V_{PIN3} = 1V$	1	2.5		1	2.5		mA
Output Source Current	$V_{PIN3} = 4V$	-0.5	-1.3		-0.5	-1.3		mA
Output High Voltage	$I_{PIN3} = -0.5mA$	4.0	4.7	5.0	4.0	4.7	5.0	V
Output Low Voltage	$I_{PIN3} = 1mA$	0	0.5	1.0	0	0.5	1.0	V
Unity Gain Bandwidth*		3	5.5		3	5.5		MHz
Slew Rate*		6	12		6	12		V/ μS
Ramp Valley to Peak*		1.6	1.8	2.0	1.6	1.8	2.0	V

* These parameters are ensured by design but not 100% tested in production.

ELECTRICAL CHARACTERISTICS: Unless otherwise noted, these specifications apply for $R_T = 3.65k$, $C_T = 1nF$, $V_{CC} = 15V$, $0^\circ C < T_A < +70^\circ C$ for the UC3823, $-25^\circ C < T_A < +85^\circ C$ for the UC2823, and $-55^\circ C < T_A < +125^\circ C$ for the UC1823, $T_A = T_J$.

PARAMETER	TEST CONDITIONS	UC1823 UC2823			UC3823			UNITS
		MIN	TYP	MAX	MIN	TYP	MAX	
PWM Comparator Section								
Pin 7 Bias Current	$V_{PIN 7} = 0V$		-1	-5		-1	-5	μA
Duty Cycle Range		0		80	0		85	%
Pin 3 Zero D.C. Threshold	$V_{PIN 7} = 0V$	1.1	1.25		1.1	1.25		V
Delay to Output*			50	80		50	80	ns
Soft-Start Section								
Charge Current	$V_{PIN 8} = 0.5V$	3	9	20	3	9	20	μA
Discharge Current	$V_{PIN 8} = 1V$	1			1			mA
Current Limit/Shutdown Section								
Pin 9 Bias Current	$0 < V_{PIN 9} < 4V$			± 10			± 10	μA
Current Limit Offset	$V_{PIN 11} = 1.1V$			15			15	mV
Current Limit Common Mode Range ($V_{PIN 11}$)		1.0		1.25	1.0		1.25	V
Shutdown Threshold		1.25	1.40	1.55	1.25	1.40	1.55	V
Delay to Output*			50	80		50	80	ns
Output Section								
Output Low Level	$I_{OUT} = 20mA$		0.25	0.40		0.25	0.40	V
	$I_{OUT} = 200mA$		1.2	2.2		1.2	2.2	V
Output High Level	$I_{OUT} = -20mA$	13.0	13.5		13.0	13.5		V
	$I_{OUT} = -200mA$	12.0	13.0		12.0	13.0		V
Collector Leakage	$V_C = 30V$		100	500		100	500	μA
Rise/Fall Time*	$C_L = 1nF$		30	60		30	60	ns
Under-Voltage Lockout Section								
Start Threshold		8.8	9.2	9.6	8.8	9.2	9.6	V
UVLO Hysteresis		0.4	0.8	1.2	0.4	0.8	1.2	V
Supply Current								
Start Up Current	$V_{CC} = 8V$		1.1	2.5		1.1	2.5	mA
I_{CC}	$V_{PIN 1}, V_{PIN 7}, V_{PIN 9} = 0V, V_{PIN 2} = 1V$		22	33		22	33	mA

* These parameters are ensured by design but not 100% tested in production.

UC1823 PRINTED CIRCUIT BOARD LAYOUT CONSIDERATIONS

High speed circuits demand careful attention to layout and component placement. To assure proper performance of the UC1823, follow these rules. 1) Use a ground plane. 2) Damp or clamp parasitic inductive kick energy from the gate of driven MOSFET. Don't allow the output pins to ring below ground. A series gate resistor or a shunt 1 Amp Schottky diode at the output pin will serve

this purpose. 3) Bypass VCC, Vc, and VREF. Use 0.1 μ F monolithic ceramic capacitors with low equivalent series inductance. Allow less than 1 cm of total lead length for each capacitor between the bypassed pin and the ground plane. 4) Treat the timing capacitor, CT, like a bypass capacitor.

ERROR AMPLIFIER CIRCUIT

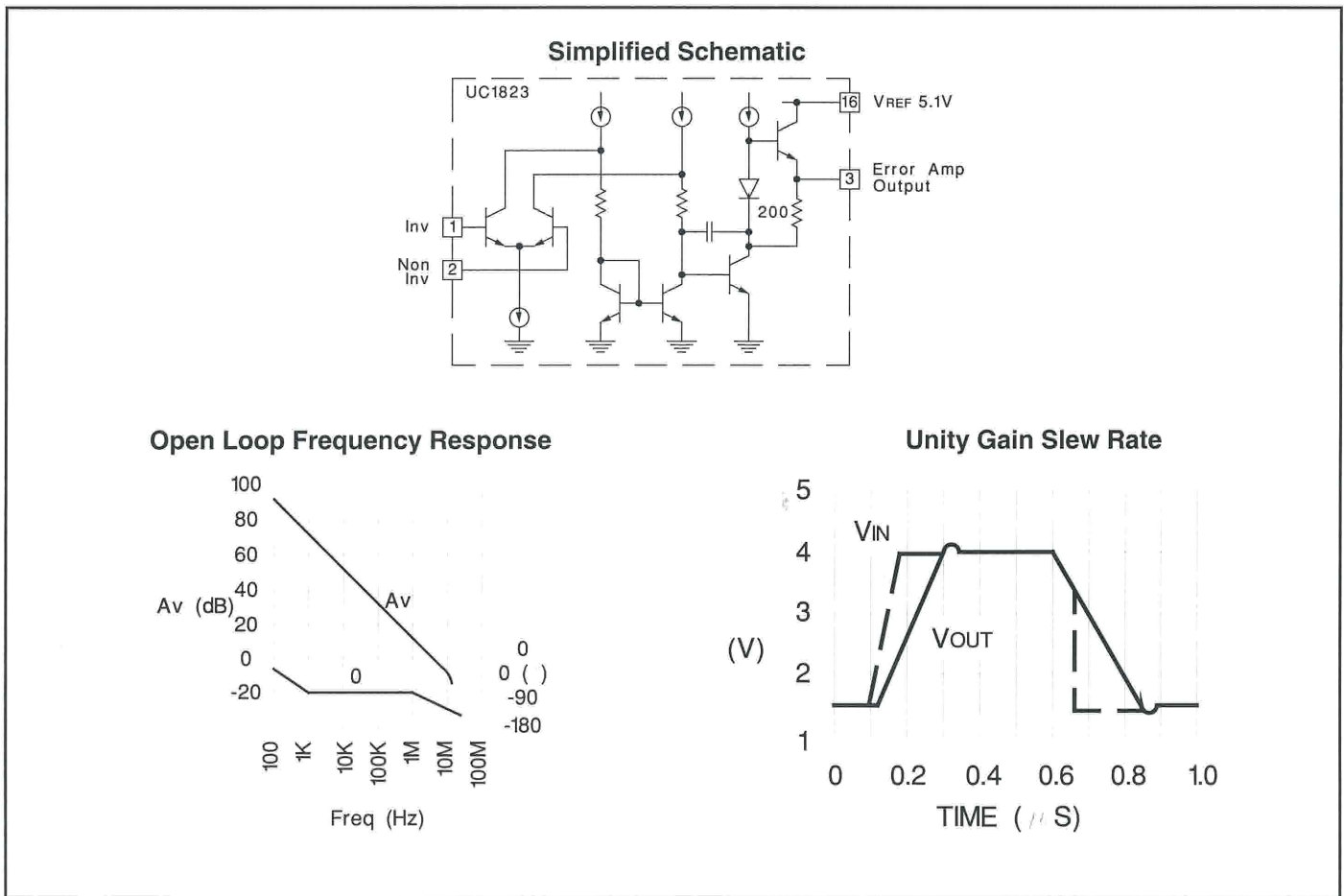

PWM APPLICATIONS

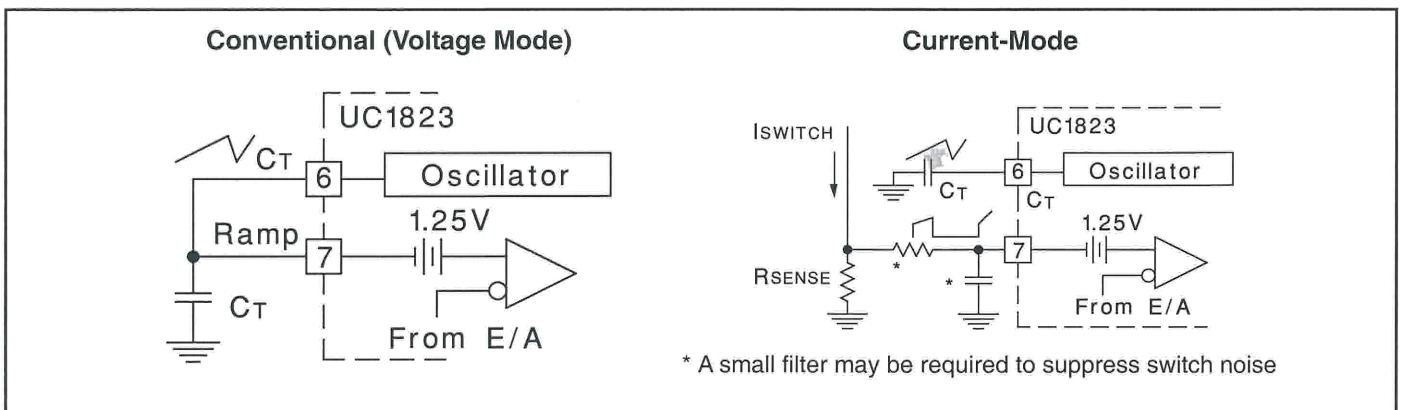

OSCILLATOR CIRCUIT

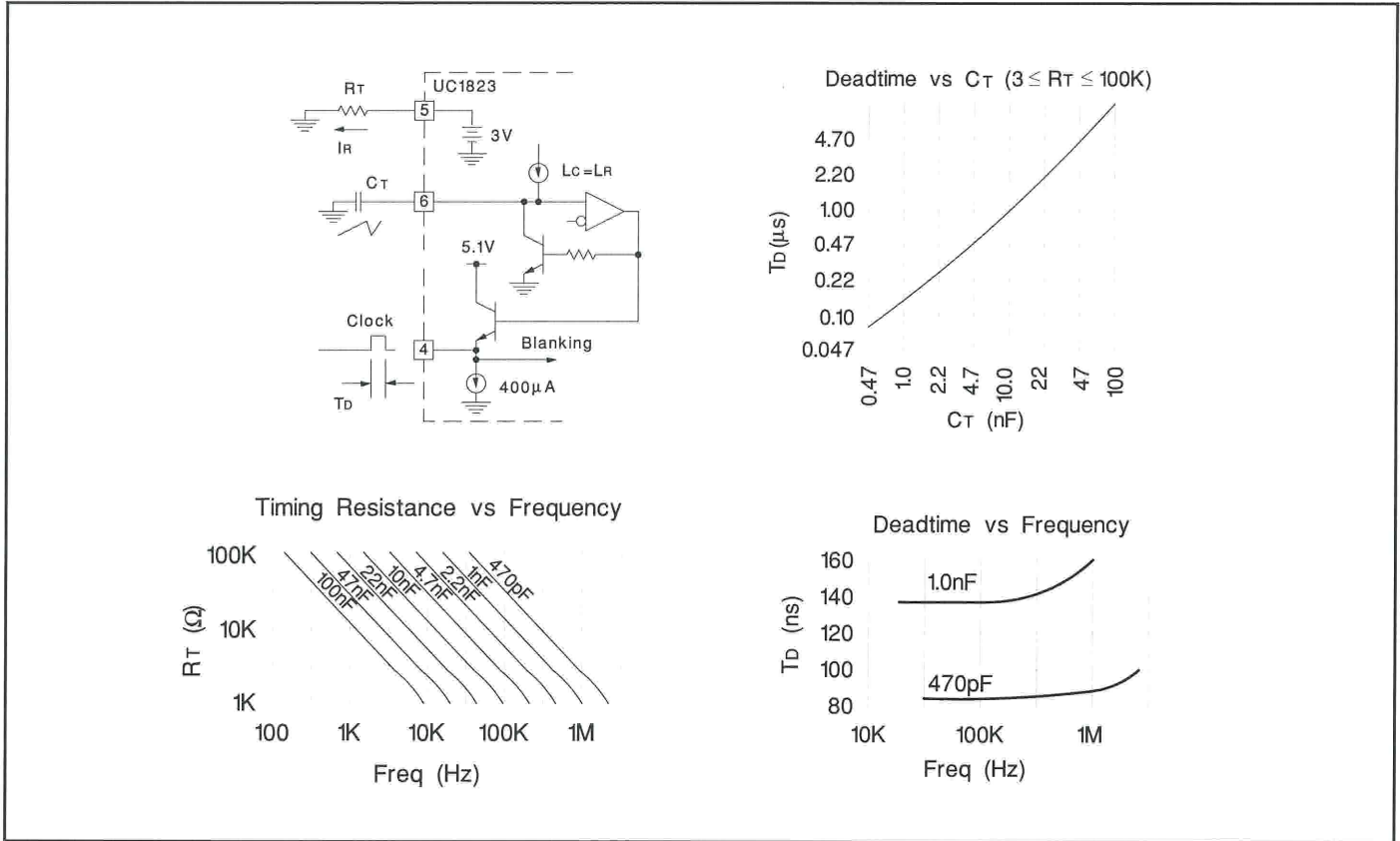

SYNCHRONIZED OPERATION

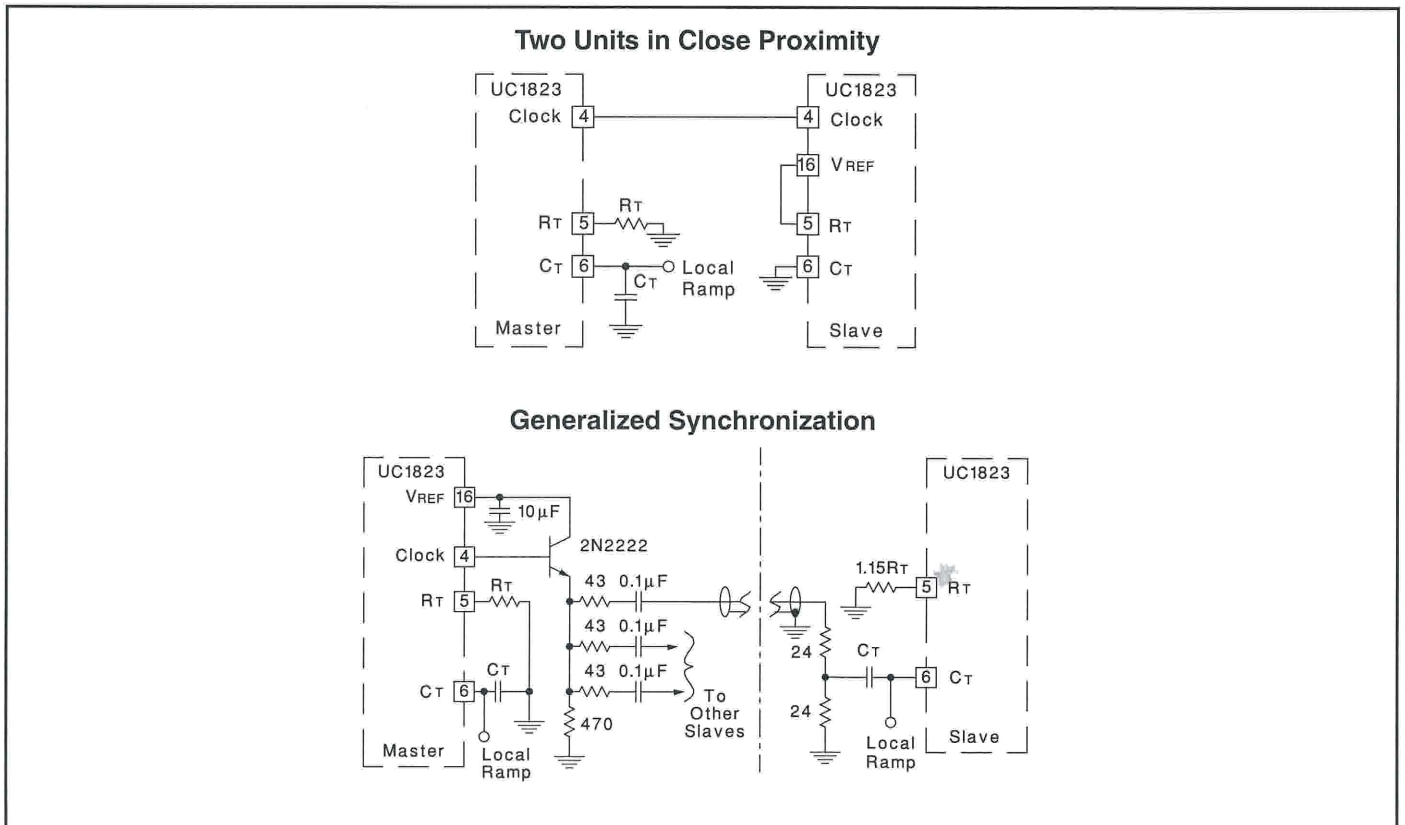

CONSTANT VOLT-SECOND CLAMP CIRCUIT

The circuit shown here will achieve a constant volt-second product clamp over varying input voltages. The ramp generator components, R_T and C_R are chosen so that the ramp at Pin 9 crosses the 1V threshold at the same time the desired maximum volt-second product is reached. The delay through the inverter must be such that the ramp capacitor can be completely discharged during the minimum deadtime.

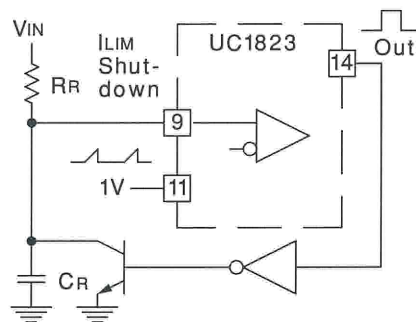

OUTPUT SECTION

Simplified Schematic

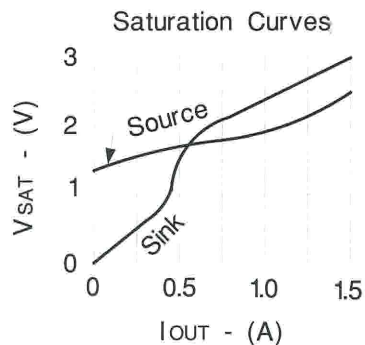
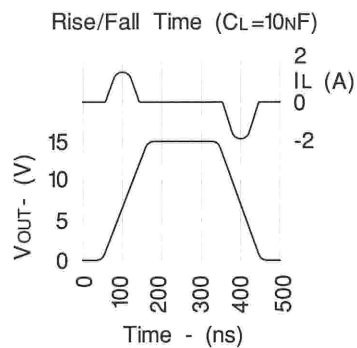
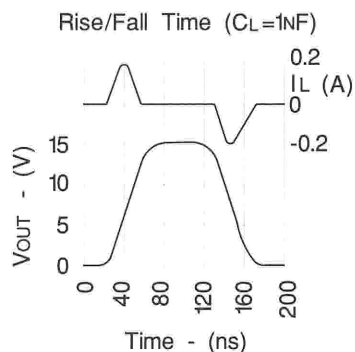
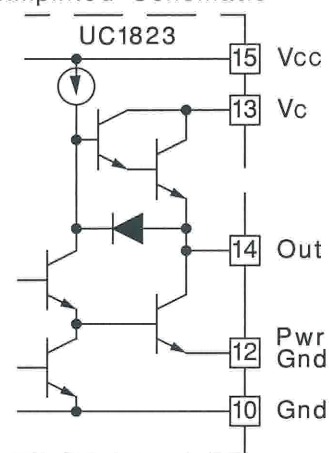

FEED FORWARD TECHNIQUE FOR OFF-LINE VOLTAGE MODE APPLICATION

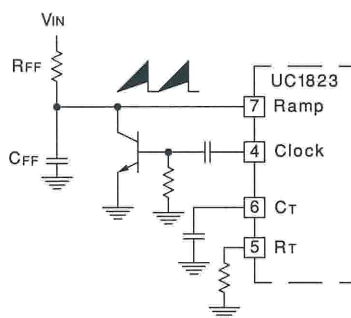

PACKAGING INFORMATION

Orderable Device	Status (1)	Package Type	Package Drawing	Pins	Package Qty	Eco Plan (2)	Lead finish/ Ball material (6)	MSL Peak Temp (3)	Op Temp (°C)	Device Marking (4/5)	Samples
5962-89905012A	ACTIVE	LCCC	FK	20	1	Non-RoHS & Green	SNPB	N / A for Pkg Type	-55 to 125	5962- 89905012A UC1823L/ 883B	Samples
5962-8990501EA	ACTIVE	CDIP	J	16	1	Non-RoHS & Green	SNPB	N / A for Pkg Type	-55 to 125	5962-8990501EA UC1823J/883B	Samples
UC1823J	ACTIVE	CDIP	J	16	1	Non-RoHS & Green	SNPB	N / A for Pkg Type	-55 to 125	UC1823J	Samples
UC1823J883B	ACTIVE	CDIP	J	16	1	Non-RoHS & Green	SNPB	N / A for Pkg Type	-55 to 125	5962-8990501EA UC1823J/883B	Samples
UC1823L	ACTIVE	LCCC	FK	20	1	Non-RoHS & Green	SNPB	N / A for Pkg Type	-55 to 125	UC1823L	Samples
UC1823L883B	ACTIVE	LCCC	FK	20	1	Non-RoHS & Green	SNPB	N / A for Pkg Type	-55 to 125	5962- 89905012A UC1823L/ 883B	Samples
UC2823DW	ACTIVE	SOIC	DW	16	40	RoHS & Green	NIPDAU	Level-2-260C-1 YEAR	-25 to 85	UC2823DW	Samples
UC2823DWTR	ACTIVE	SOIC	DW	16	2000	RoHS & Green	NIPDAU	Level-2-260C-1 YEAR	-25 to 85	UC2823DW	Samples
UC2823N	ACTIVE	PDIP	N	16	25	RoHS & Green	NIPDAU	N / A for Pkg Type	-25 to 85	UC2823N	Samples
UC3823DW	ACTIVE	SOIC	DW	16	40	RoHS & Green	NIPDAU	Level-2-260C-1 YEAR	0 to 70	UC3823DW	Samples
UC3823DWG4	ACTIVE	SOIC	DW	16	40	RoHS & Green	NIPDAU	Level-2-260C-1 YEAR	0 to 70	UC3823DW	Samples
UC3823DWTR	ACTIVE	SOIC	DW	16	2000	RoHS & Green	NIPDAU	Level-2-260C-1 YEAR	0 to 70	UC3823DW	Samples
UC3823N	ACTIVE	PDIP	N	16	25	RoHS & Green	NIPDAU	N / A for Pkg Type	0 to 70	UC3823N	Samples
UC3823NG4	ACTIVE	PDIP	N	16	25	RoHS & Green	NIPDAU	N / A for Pkg Type	0 to 70	UC3823N	Samples

(1) The marketing status values are defined as follows:

ACTIVE: Product device recommended for new designs.

LIFEBUY: TI has announced that the device will be discontinued, and a lifetime-buy period is in effect.

NRND: Not recommended for new designs. Device is in production to support existing customers, but TI does not recommend using this part in a new design.

PREVIEW: Device has been announced but is not in production. Samples may or may not be available.

OBSOLETE: TI has discontinued the production of the device.

(2) **RoHS:** TI defines "RoHS" to mean semiconductor products that are compliant with the current EU RoHS requirements for all 10 RoHS substances, including the requirement that RoHS substance do not exceed 0.1% by weight in homogeneous materials. Where designed to be soldered at high temperatures, "RoHS" products are suitable for use in specified lead-free processes. TI may reference these types of products as "Pb-Free".

RoHS Exempt: TI defines "RoHS Exempt" to mean products that contain lead but are compliant with EU RoHS pursuant to a specific EU RoHS exemption.

Green: TI defines "Green" to mean the content of Chlorine (Cl) and Bromine (Br) based flame retardants meet JS709B low halogen requirements of ≤ 1000 ppm threshold. Antimony trioxide based flame retardants must also meet the ≤ 1000 ppm threshold requirement.

(3) MSL, Peak Temp. - The Moisture Sensitivity Level rating according to the JEDEC industry standard classifications, and peak solder temperature.

(4) There may be additional marking, which relates to the logo, the lot trace code information, or the environmental category on the device.

(5) Multiple Device Markings will be inside parentheses. Only one Device Marking contained in parentheses and separated by a "~" will appear on a device. If a line is indented then it is a continuation of the previous line and the two combined represent the entire Device Marking for that device.

(6) Lead finish/Ball material - Orderable Devices may have multiple material finish options. Finish options are separated by a vertical ruled line. Lead finish/Ball material values may wrap to two lines if the finish value exceeds the maximum column width.

Important Information and Disclaimer:The information provided on this page represents TI's knowledge and belief as of the date that it is provided. TI bases its knowledge and belief on information provided by third parties, and makes no representation or warranty as to the accuracy of such information. Efforts are underway to better integrate information from third parties. TI has taken and continues to take reasonable steps to provide representative and accurate information but may not have conducted destructive testing or chemical analysis on incoming materials and chemicals. TI and TI suppliers consider certain information to be proprietary, and thus CAS numbers and other limited information may not be available for release.

In no event shall TI's liability arising out of such information exceed the total purchase price of the TI part(s) at issue in this document sold by TI to Customer on an annual basis.

OTHER QUALIFIED VERSIONS OF UC1823, UC3823 :

● Catalog : [UC3823](#)

● Military : [UC1823](#)

NOTE: Qualified Version Definitions:

● Catalog - TI's standard catalog product

● Military - QML certified for Military and Defense Applications

TAPE AND REEL INFORMATION

QUADRANT ASSIGNMENTS FOR PIN 1 ORIENTATION IN TAPE

*All dimensions are nominal

Device	Package Type	Package Drawing	Pins	SPQ	Reel Diameter (mm)	Reel Width W1 (mm)	A0 (mm)	B0 (mm)	K0 (mm)	P1 (mm)	W (mm)	Pin1 Quadrant
UC2823DWTR	SOIC	DW	16	2000	330.0	16.4	10.75	10.7	2.7	12.0	16.0	Q1
UC3823DWTR	SOIC	DW	16	2000	330.0	16.4	10.75	10.7	2.7	12.0	16.0	Q1

TAPE AND REEL BOX DIMENSIONS

*All dimensions are nominal

Device	Package Type	Package Drawing	Pins	SPQ	Length (mm)	Width (mm)	Height (mm)
UC2823DWTR	SOIC	DW	16	2000	356.0	356.0	35.0
UC3823DWTR	SOIC	DW	16	2000	356.0	356.0	35.0

TUBE

*All dimensions are nominal

Device	Package Name	Package Type	Pins	SPQ	L (mm)	W (mm)	T (μm)	B (mm)
5962-89905012A	FK	LCCC	20	1	506.98	12.06	2030	NA
UC1823L	FK	LCCC	20	1	506.98	12.06	2030	NA
UC1823L883B	FK	LCCC	20	1	506.98	12.06	2030	NA
UC2823DW	DW	SOIC	16	40	507	12.83	5080	6.6
UC2823N	N	PDIP	16	25	506	13.97	11230	4.32
UC3823DW	DW	SOIC	16	40	507	12.83	5080	6.6
UC3823DWG4	DW	SOIC	16	40	507	12.83	5080	6.6
UC3823N	N	PDIP	16	25	506	13.97	11230	4.32
UC3823NG4	N	PDIP	16	25	506	13.97	11230	4.32

IMPORTANT NOTICE AND DISCLAIMER

TI PROVIDES TECHNICAL AND RELIABILITY DATA (INCLUDING DATA SHEETS), DESIGN RESOURCES (INCLUDING REFERENCE DESIGNS), APPLICATION OR OTHER DESIGN ADVICE, WEB TOOLS, SAFETY INFORMATION, AND OTHER RESOURCES "AS IS" AND WITH ALL FAULTS, AND DISCLAIMS ALL WARRANTIES, EXPRESS AND IMPLIED, INCLUDING WITHOUT LIMITATION ANY IMPLIED WARRANTIES OF MERCHANTABILITY, FITNESS FOR A PARTICULAR PURPOSE OR NON-INFRINGEMENT OF THIRD PARTY INTELLECTUAL PROPERTY RIGHTS.

These resources are intended for skilled developers designing with TI products. You are solely responsible for (1) selecting the appropriate TI products for your application, (2) designing, validating and testing your application, and (3) ensuring your application meets applicable standards, and any other safety, security, regulatory or other requirements.

These resources are subject to change without notice. TI grants you permission to use these resources only for development of an application that uses the TI products described in the resource. Other reproduction and display of these resources is prohibited. No license is granted to any other TI intellectual property right or to any third party intellectual property right. TI disclaims responsibility for, and you will fully indemnify TI and its representatives against, any claims, damages, costs, losses, and liabilities arising out of your use of these resources.

TI's products are provided subject to [TI's Terms of Sale](#) or other applicable terms available either on [ti.com](https://www.ti.com) or provided in conjunction with such TI products. TI's provision of these resources does not expand or otherwise alter TI's applicable warranties or warranty disclaimers for TI products.

TI objects to and rejects any additional or different terms you may have proposed.

Mailing Address: Texas Instruments, Post Office Box 655303, Dallas, Texas 75265
Copyright © 2023, Texas Instruments Incorporated