

ESD341 1-Channel ± 30 kV ESD Protection Diode in 0201 Package

1 Features

- IEC 61000-4-2 level 4 ESD protection
 - 30 kV contact discharge
 - 30 kV air gap discharge
- IEC 61000-4-5 surge protection
 - 5.4 A (8/20 μ s)
- IO capacitance:
 - 0.66 pF (typical)
- DC breakdown voltage: ± 6.2 V (typical)
- Ultra low leakage current: 100 nA (maximum)
- Low ESD clamping voltage: 10.2 V at 16 A TLP
- Low insertion loss: 5 GHz (-3 dB bandwidth, DPL)
- Supports high speed interfaces up to 3.4 Gbps
- Industrial temperature range: -40°C to $+125^{\circ}\text{C}$
- Space-saving industry standard 0201 footprint (0.6 mm \times 0.3 mm \times 0.3 mm)

2 Applications

- End equipment:
 - [Wearables](#)
 - [Smart speakers](#)
 - [Portable electronics](#)
 - [Small appliances](#)
 - [Laptops and desktops](#)
 - [TV and monitors](#)
 - [Head unit](#)
 - [Rear seat entertainment](#)
 - [Docking stations](#)
- Interfaces:
 - USB 2.0
 - USB 3.0
 - HDMI 1.4 and 2.0
 - [LVDS](#)
 - DisplayPort
 - SIM card

3 Description

The ESD341 is a bidirectional TVS ESD protection diode for HDMI 1.4 circuit protection. The ESD341 is rated to dissipate ESD strikes at the maximum level specified in the IEC 61000-4-2 international standard (Level 4).

This device features a 0.66 pF (typical) IO capacitance enabling high-speed interface protection up to 3.4 Gbps including support for protocols such as HDMI 1.4b. The low dynamic resistance and low clamping voltage ensure system level protection against transient events.

The 30 kV ESD rating and 5.4 A surge provides robust transient protection in a tiny package for protecting 3.6 V power rails in portable electronics and other space constrained applications such as wearables.

The ESD341 is offered in the industry standard 0201 (DPL) package.

Device Information⁽¹⁾

PART NUMBER	PACKAGE	BODY SIZE (NOM)
ESD341	X2SON (2)	0.60 mm \times 0.30 mm

(1) For all available packages, see the orderable addendum at the end of the data sheet.



Copyright © 2022, Texas Instruments Incorporated

Typical Application



Table of Contents

1 Features	1	8 Application and Implementation	9
2 Applications	1	8.1 Application Information.....	9
3 Description	1	8.2 Typical Application.....	9
4 Revision History	2	9 Power Supply Recommendations	11
5 Pin Configuration and Functions	3	10 Layout	11
6 Specifications	4	10.1 Layout Guidelines.....	11
Absolute Maximum Ratings.....	4	10.2 Layout Example.....	11
6.1 ESD Ratings—JEDEC Specification.....	4	11 Device and Documentation Support	12
6.2 ESD Ratings—IEC Specification.....	4	11.1 Documentation Support.....	12
Recommended Operating Conditions.....	4	11.2 Receiving Notification of Documentation Updates..	12
6.3 Thermal Information.....	4	11.3 Support Resources.....	12
6.4 Electrical Characteristics.....	5	11.4 Trademarks.....	12
6.5 Typical Characteristics.....	6	11.5 Electrostatic Discharge Caution.....	12
7 Detailed Description	8	11.6 Glossary.....	12
7.1 Overview.....	8	12 Mechanical, Packaging, and Orderable Information	12
7.2 Functional Block Diagram.....	8	12.1 Tape and Reel Information.....	14
7.3 Feature Description.....	8		
7.4 Device Functional Modes.....	8		

4 Revision History

NOTE: Page numbers for previous revisions may differ from page numbers in the current version.

Changes from Revision * (April 2022) to Revision A (July 2022)	Page
• Changed the status of the data sheet from: <i>Advanced Information</i> to: <i>Production Data</i>	1

5 Pin Configuration and Functions

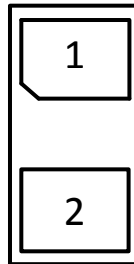

Figure 5-1. DPL Package, 2-Pin X2SON (Top View)

Table 5-1. Pin Functions

PIN		TYPE ⁽¹⁾	DESCRIPTION
NO.	NAME		
1	IO	I/O	ESD Protected Channel. If used as ESD IO, connect pin 2 to ground
2	IO	I/O	ESD Protected Channel. If used as ESD IO, connect pin 1 to ground

(1) I = input, O = output

6 Specifications

Absolute Maximum Ratings

over operating free-air temperature range (unless otherwise noted) ⁽¹⁾

		MIN	MAX	UNIT
Peak Pulse ^{(2) (3)}	IEC 61000-4-5 power ($t_p - 8/20 \mu s$)		54	W
	IEC 61000-4-5 Current ($t_p - 8/20 \mu s$)		5.4	A
T_A	Ambient Operating Temperature	-40	125	°C
T_J	Junction Temperature	-40	125	°C
T_{stg}	Storage Temperature	-65	155	°C

- (1) Operation outside the Absolute Maximum Ratings may cause permanent device damage. Absolute maximum ratings do not imply functional operation of the device at these or any other conditions beyond those listed under Recommended Operating Conditions. If briefly operating outside the Recommended Operating Conditions but within the Absolute Maximum Ratings, the device may not sustain damage, but it may not be fully functional. Operating the device in this manner may affect device reliability, functionality, performance, and shorten the device lifetime.
- (2) Voltages are with respect to GND unless otherwise noted.
- (3) Measured at 25°C

6.1 ESD Ratings—JEDEC Specification

			VALUE	UNIT
$V_{(ESD)}$	Electrostatic discharge	Human body model (HBM), per ANSI/ESDA/ JEDEC JS-001	±2500	V
		Charged device model (CDM), per JEDEC specification JS-002	±1000	V

6.2 ESD Ratings—IEC Specification

			VALUE	UNIT
$V_{(ESD)}$	Electrostatic discharge	IEC 61000-4-2 contact discharge	±30000	V
		IEC 61000-4-2 air-gap discharge	±30000	

Recommended Operating Conditions

over operating free-air temperature range (unless otherwise noted)

			MIN	NOM	MAX	UNIT
V_{IO}	Input pin voltage	Pin 1 to 2 or Pin 2 to 1	-3.6		3.6	V
T_A	Operating free-air temperature		-40		125	°C

6.3 Thermal Information

THERMAL METRIC ⁽¹⁾		ESD341	UNIT
		DPL (X2SON)	
		2 PINS	
$R_{\theta JA}$	Junction-to-ambient thermal resistance	356.8	°C/W
$R_{\theta JC(top)}$	Junction-to-case (top) thermal resistance	208.8	°C/W
$R_{\theta JB}$	Junction-to-board thermal resistance	136.2	°C/W
Ψ_{JT}	Junction-to-top characterization parameter	3.0	°C/W
Ψ_{JB}	Junction-to-board characterization parameter	135.7	°C/W
$R_{\theta JC(bot)}$	Junction-to-case (bottom) thermal resistance	NA	°C/W

- (1) For more information about traditional and new thermal metrics, see the [Semiconductor and IC Package Thermal Metrics](#) application report.

6.4 Electrical Characteristics

over operating free-air temperature range (unless otherwise noted) ⁽¹⁾

PARAMETER		TEST CONDITION	MIN	TYP	MAX	UNIT
V _{RWM}	Reverse stand-off voltage	Pin 1 to Pin 2 or Pin 2 to Pin 1	-3.6		3.6	V
V _{BRF}	Break-down voltage	I _{IO} = 1 mA, Pin 1 to Pin 2	5	6.2	7.2	V
V _{BRR}	Break-down voltage	I _{IO} = -1 mA, Pin 2 to Pin 1	-7.2	-6.2	-5	V
V _{HOLD}	Holding voltage ⁽²⁾	TLP, Pin 1 to Pin 2 or Pin 2 to Pin 1		6.2		V
V _{Clamp_TLP}	Clamp voltage with TLP ⁽²⁾	I _{PP} = 1 A, TLP, Pin 1 to Pin 2		6.3		V
		I _{PP} = 5 A, TLP, Pin 1 to Pin 2		7.4		
		I _{PP} = 16 A, TLP, Pin 1 to Pin 2		10.2		
		I _{PP} = 1 A, TLP, Pin 2 to Pin 1		6.3		
		I _{PP} = 5 A, TLP, Pin 2 to Pin 1		7.4		
		I _{PP} = 16 A, TLP, Pin 2 to Pin 1		10.2		
V _{Clamp_Surge}	Clamp voltage with surge strike ⁽⁴⁾	I _{PP} = 5.4 A, t _p = 8/20 μs, Pin 1 to Pin 2 or Pin 2 to Pin 1		8.8		V
I _{LEAK}	Leakage current	V _{IO} = 3.6 V, Pin 1 to Pin 2 or Pin 2 to Pin 1		5	100	nA
R _{DYN}	Dynamic resistance ⁽³⁾	Pin 1 to Pin 2		0.25		Ω
		Pin 2 to Pin 1				
C _L	Line capacitance	V _{IO} = 0 V; f = 1 MHz, Pin 1 to Pin 2, T _A = 25°C		0.66		pF

(1) Typical parameters are measured at 25°C

(2) Transition line pulse with 100 ns width and 10 ns rise and fall time

(3) Extraction of R_{DYN} using least squares fit of TLP characteristics between I = 10 A and I = 20 A

(4) Nonrepetitive current pulse 8 to 20 μs exponentially decaying waveform according to IEC 61000-4-5

6.5 Typical Characteristics

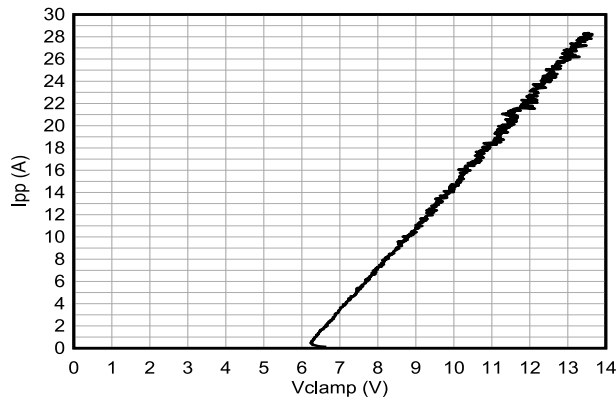

tp = 100 ns, Transmission Line Pulse (TLP)

Figure 6-1. Positive TLP Curve

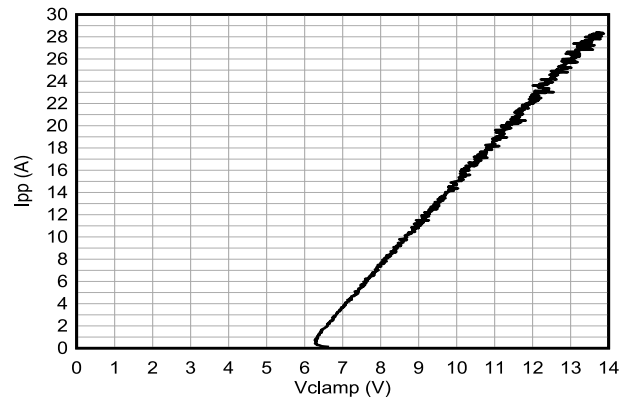

tp = 100 ns, Transmission Line Pulse (TLP)

Figure 6-2. Negative TLP Curve

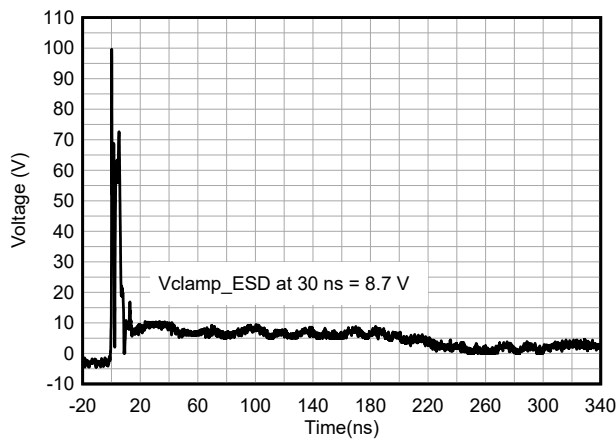

Figure 6-3. +8-kV Clamped IEC Waveform

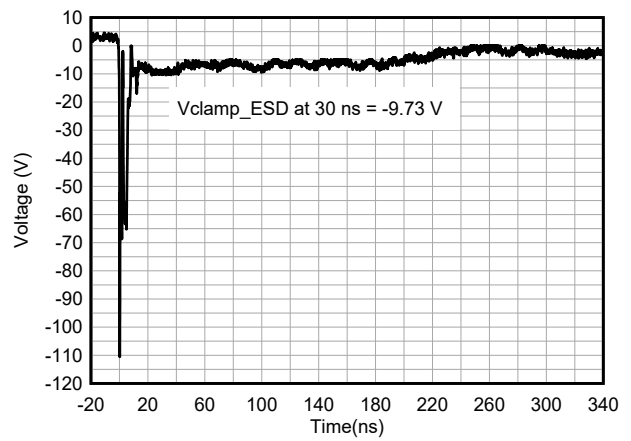

Figure 6-4. -8-kV Clamped IEC Waveform

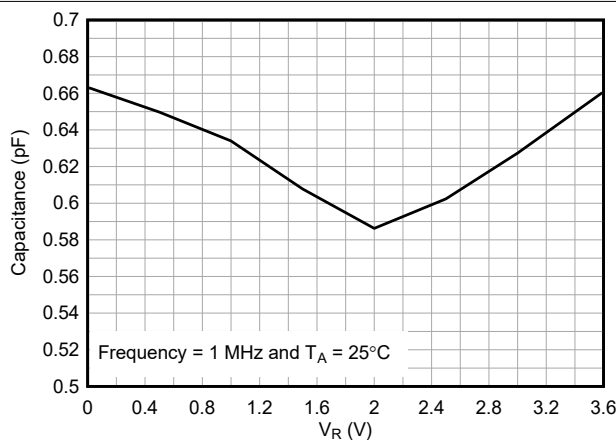

Figure 6-5. Bias Voltage vs. Capacitance

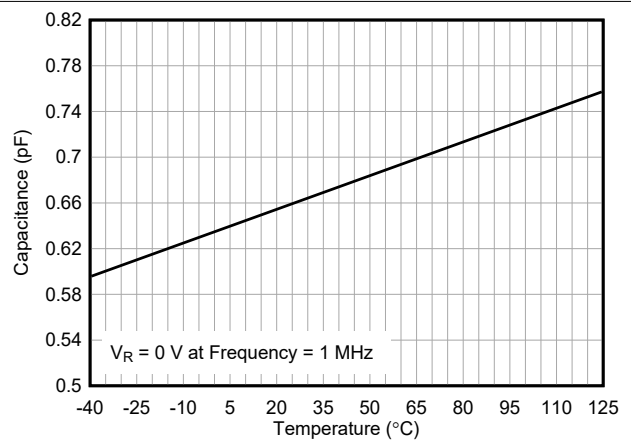
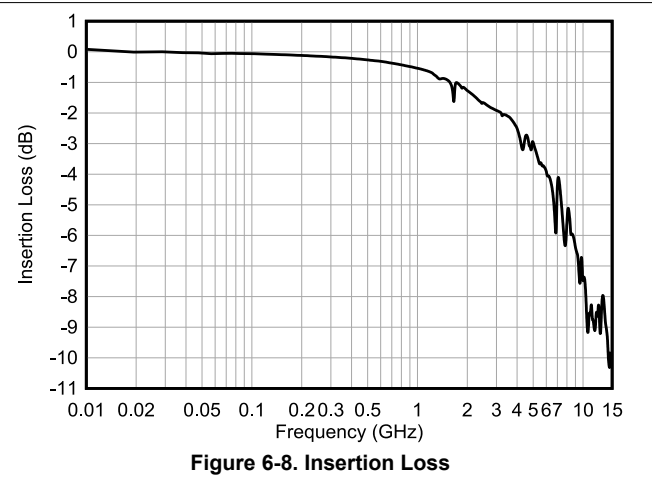
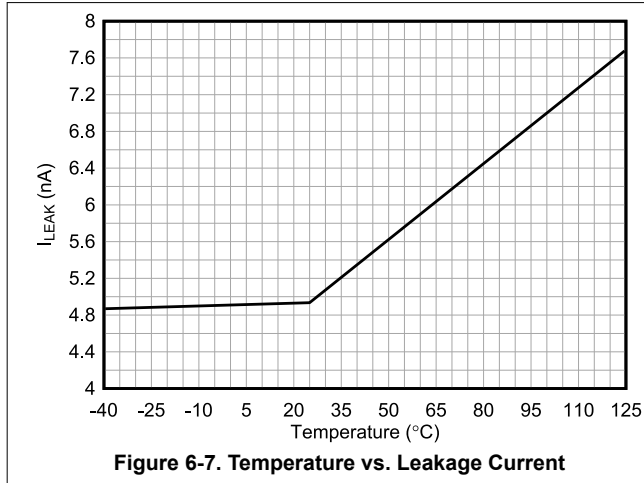

Figure 6-6. Temperature vs. Capacitance

6.5 Typical Characteristics (continued)



7 Detailed Description

7.1 Overview

The ESD341 device is a bidirectional ESD Protection Diode with ultra-low capacitance. This device can dissipate ESD strikes above the maximum level specified by the IEC 61000-4-2 International Standard. The ultra-low capacitance allows this device to protect high-speed signal pins including HDMI 1.4b.

7.2 Functional Block Diagram

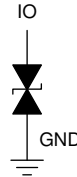

Copyright © 2016, Texas Instruments Incorporated

7.3 Feature Description

7.3.1 IEC 61000-4-2 ESD Protection

The I/O pins can withstand ESD events up to ± 30 kV contact and ± 30 kV air gap. An ESD-surge clamp diverts the current to ground.

7.3.2 IEC 61000-4-5 Surge Protection

The I/O pins can withstand surge events up to 5.4 A and 54 W (8/20 μ s waveform). An ESD-surge clamp diverts this current to ground.

7.3.3 IO Capacitance

The capacitance between each I/O pin to ground is 0.66 pF (typical). This device supports data rates up to 3.4 Gbps.

7.3.4 DC Breakdown Voltage

The DC breakdown voltage of each I/O pin is ± 6.2 V (typical). This DC breakdown voltage ensures that sensitive equipment is protected from surges above the reverse standoff voltage of ± 3.6 V.

7.3.5 Ultra Low Leakage Current

The I/O pins feature an ultra-low leakage current of 100 nA (maximum) with a bias of ± 3.6 V.

7.3.6 Low ESD Clamping Voltage

The I/O pins feature an ESD clamp that is capable of clamping the voltage to 7.4 V ($I_{PP} = 5$ A, TLP).

7.3.7 Supports High Speed Interfaces

This device is capable of supporting high speed interfaces up to 3.4 Gbps, because of the extremely low IO capacitance.

7.3.8 Industrial Temperature Range

This device features an industrial operating range of -40°C to $+125^{\circ}\text{C}$.

7.4 Device Functional Modes

The ESD341 device is a passive integrated circuit that triggers when voltages are above V_{BRF} or below V_{BRR} . During ESD events, voltages as high as ± 30 kV (air or contact) can be directed to ground through the internal diode network. When the voltages on the protected line fall below the V_{HOLD} of ESD341 (usually within 10s of nano-seconds) the device reverts to passive.

8 Application and Implementation

Note

Information in the following applications sections is not part of the TI component specification, and TI does not warrant its accuracy or completeness. TI's customers are responsible for determining suitability of components for their purposes, as well as validating and testing their design implementation to confirm system functionality.

8.1 Application Information

The ESD341 is a diode type TVS which provides a path to ground for dissipating ESD events on high-speed signal lines between a human interface connector and a system. As the current from ESD passes through the TVS, only a small voltage drop is present across the diode. This is the voltage presented to the protected IC. The low R_{DYN} of the triggered TVS holds this voltage (V_{CLAMP}) to a safe level for the protected IC.

8.2 Typical Application

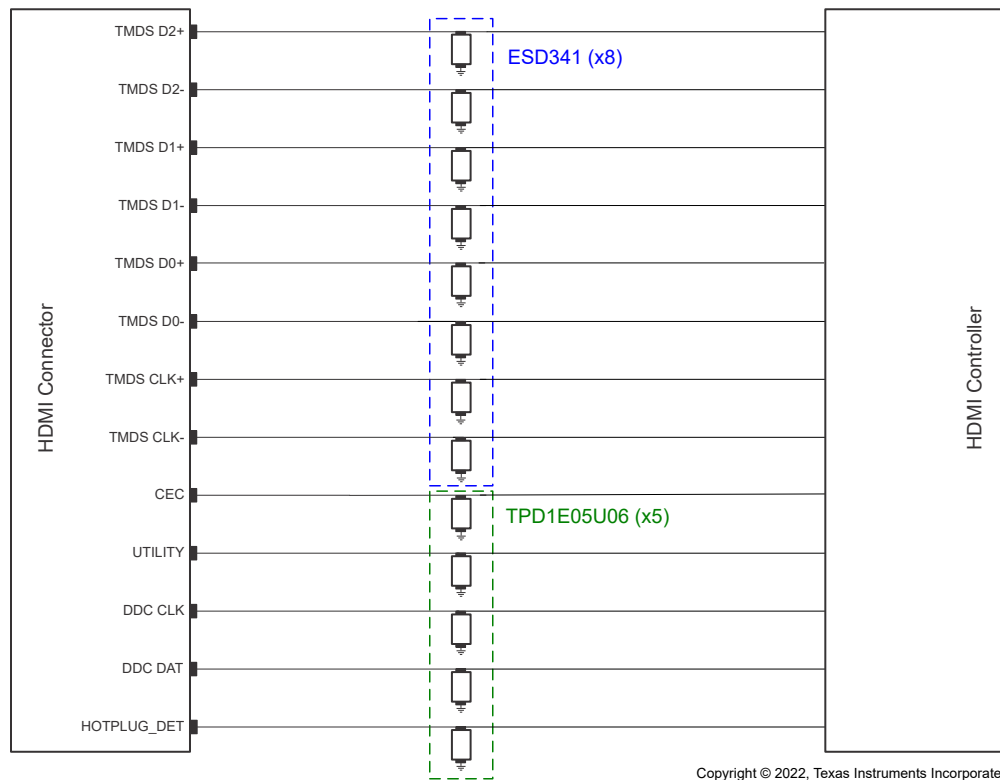

Figure 8-1. HDMI 1.4 Application

8.2.1 Design Requirements

For this design example, 8 ESD341 devices and 5 TPD1E05U06 devices are being used in an HDMI 1.4 application, which provides a complete port protection scheme.

Table 8-1 lists the parameters for the HDMI 1.4 application.

Table 8-1. Design Parameters

DESIGN PARAMETER	VALUE
TMDS signal range on pins	0 V to 3.6 V
Other signal range on pins	0 V to 5 V
Operating frequency	1.7 GHz

8.2.2 Detailed Design Procedure

8.2.2.1 Signal Range

The ESD341 supports signal ranges between -3.6 V and 3.6 V, which supports the TMDS signals. The TPD1E05U06 supports signal ranges between 0 V and 5.5 V, which supports the other signals (CEC, UTILITY, DDC CLK, DDC DAT, and HOTPLUG_DET) in the HDMI 1.4 application.

8.2.2.2 Operating Frequency

The ESD341 has a 0.66 pF (typical) capacitance, which supports the 3.4 Gbps data rate needed for the HDMI 1.4 application.

8.2.3 Application Curves

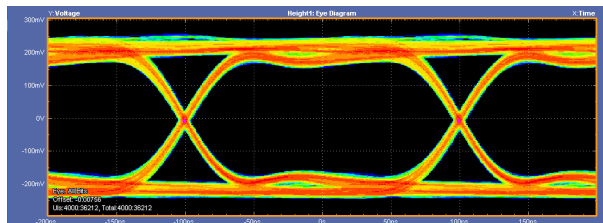

Figure 8-2. Data Rate > 3.4 Gbps Eye Diagram (Bare Board)

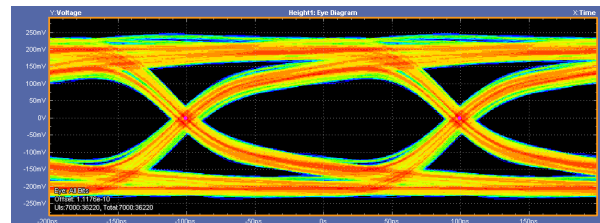

Figure 8-3. Data Rate > 3.4 Gbps Eye Diagram (with ESD341)

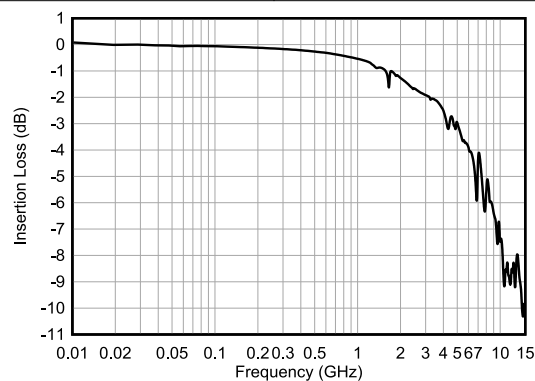

Figure 8-4. Insertion Loss

9 Power Supply Recommendations

This is a passive TVS diode-based ESD protection device, therefore there is no need to power it. Take care that the maximum voltage specifications for each pin are not violated.

10 Layout

10.1 Layout Guidelines

- The optimum placement of the ESD protection device is as close to the connector as possible
 - EMI during an ESD event can couple from the trace being struck to other nearby unprotected traces, resulting in early system failures
 - The PCB designer must minimize the possibility of EMI coupling by keeping any unprotected traces away from the protected traces which are between the TVS and the connector
- Route the protected traces as straight as possible
- Eliminate any sharp corners on the protected traces between the TVS and the connector by using rounded corners with the largest radii possible
 - Electric fields tend to build up on corners, increasing EMI coupling
- If pin 1 or pin 2 is connected to ground, use a thick and short trace for this return path

10.2 Layout Example

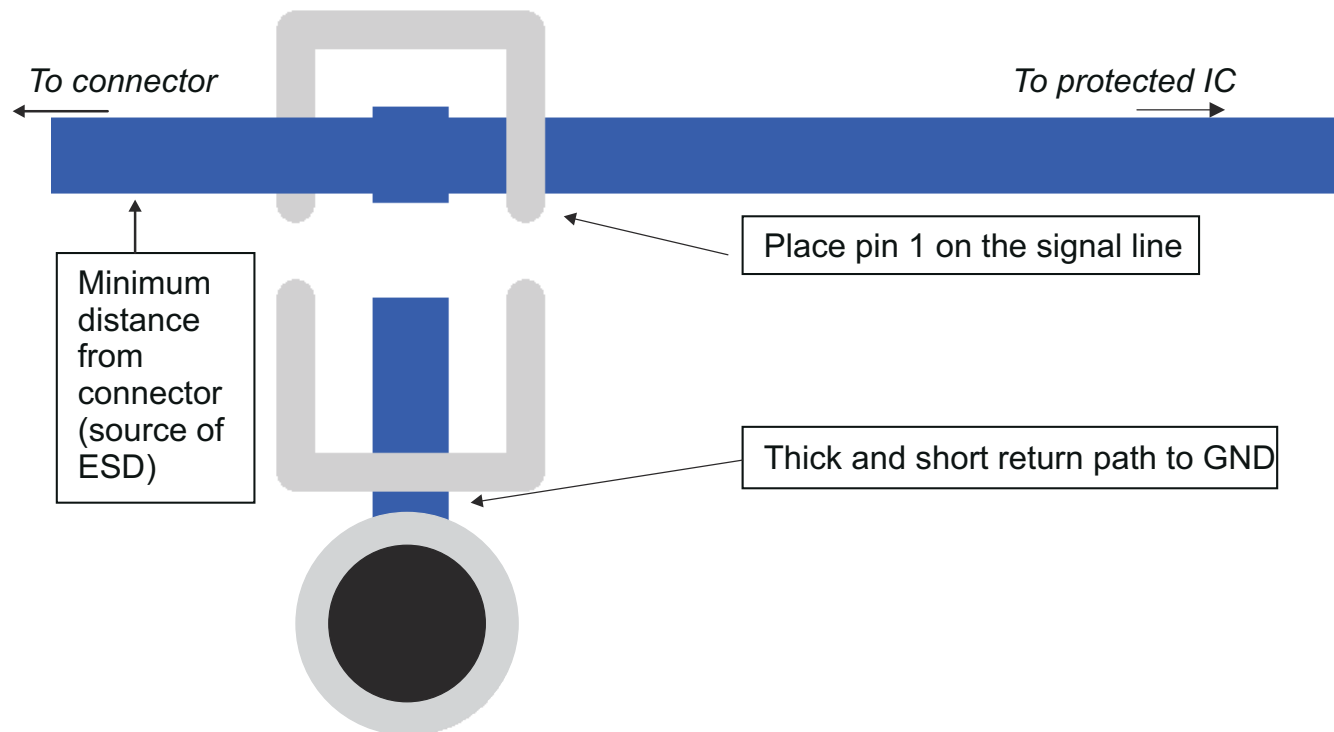

Figure 10-1. Layout Recommendation

11 Device and Documentation Support

11.1 Documentation Support

11.1.1 Related Documentation

For related documentation, see the following:

- Texas Instruments, [ESD Layout Guide application reports](#)
- Texas Instruments, [Generic ESD Evaluation Module user's guide](#)
- Texas Instruments, [Picking ESD Diodes for Ultra High-Speed Data Lines application reports](#)
- Texas Instruments, [Reading and Understanding an ESD Protection data sheet](#)

11.2 Receiving Notification of Documentation Updates

To receive notification of documentation updates, navigate to the device product folder on [ti.com](#). Click on *Subscribe to updates* to register and receive a weekly digest of any product information that has changed. For change details, review the revision history included in any revised document.

11.3 Support Resources

[TI E2E™ support forums](#) are an engineer's go-to source for fast, verified answers and design help — straight from the experts. Search existing answers or ask your own question to get the quick design help you need.

Linked content is provided "AS IS" by the respective contributors. They do not constitute TI specifications and do not necessarily reflect TI's views; see TI's [Terms of Use](#).

11.4 Trademarks

TI E2E™ is a trademark of Texas Instruments.

All trademarks are the property of their respective owners.

11.5 Electrostatic Discharge Caution



This integrated circuit can be damaged by ESD. Texas Instruments recommends that all integrated circuits be handled with appropriate precautions. Failure to observe proper handling and installation procedures can cause damage.

ESD damage can range from subtle performance degradation to complete device failure. Precision integrated circuits may be more susceptible to damage because very small parametric changes could cause the device not to meet its published specifications.

11.6 Glossary

[TI Glossary](#) This glossary lists and explains terms, acronyms, and definitions.

12 Mechanical, Packaging, and Orderable Information

The following pages include mechanical, packaging, and orderable information. This information is the most current data available for the designated devices. This data is subject to change without notice and revision of this document. For browser-based versions of this data sheet, refer to the left-hand navigation.

MECHANICAL DATA

DPL (R-PX2SON-N2)

PLASTIC SMALL OUTLINE NO-LEAD

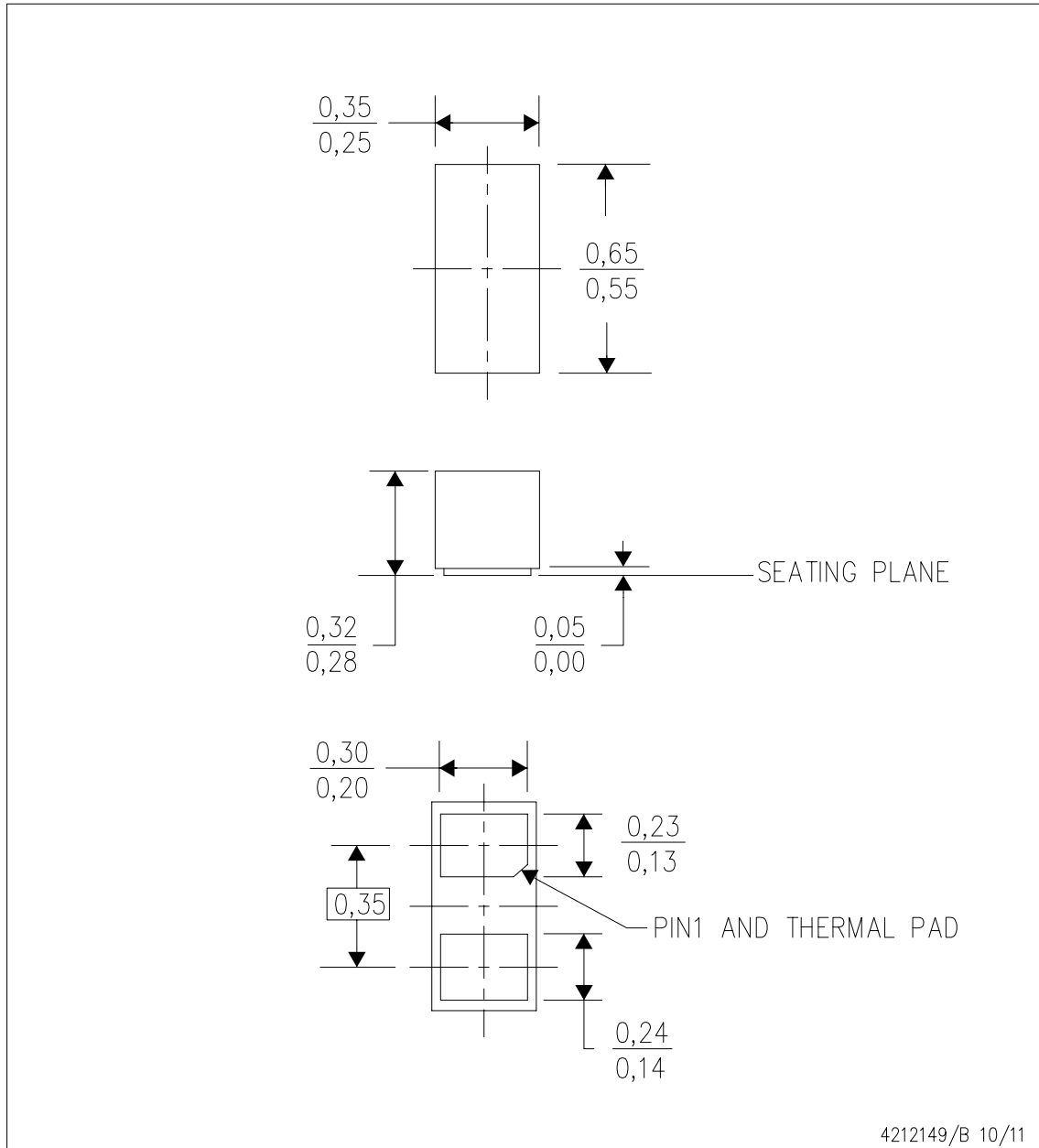

- NOTES:
- A. All linear dimensions are in millimeters. Dimensioning and tolerancing per ASME Y14.5M-1994.
 - B. This drawing is subject to change without notice.
 - C. Small Outline No-Lead (SON) package configuration.
 - D. The package thermal pad must be soldered to the board for thermal and mechanical performance.

12.1 Tape and Reel Information

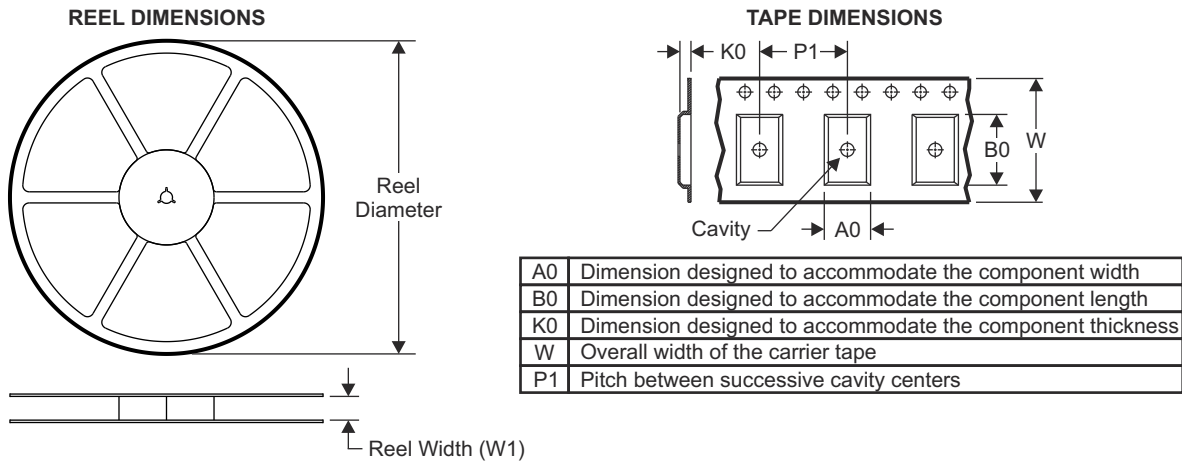

QUADRANT ASSIGNMENTS FOR PIN 1 ORIENTATION IN TAPE

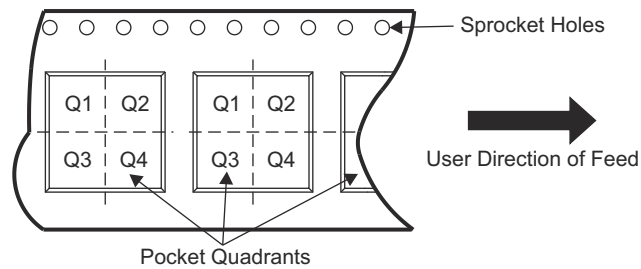

Device	Package Type	Package Drawing	Pins	SPQ	Reel Diameter (mm)	Reel Width W1 (mm)	A0 (mm)	B0 (mm)	K0 (mm)	P1 (mm)	W (mm)	Pin1 Quadrant
ESD341DPLR	X2SON	DPL	2	15000	178	8.4	0.36	0.66	0.33	0.2	8	Q1

TAPE AND REEL BOX DIMENSIONS

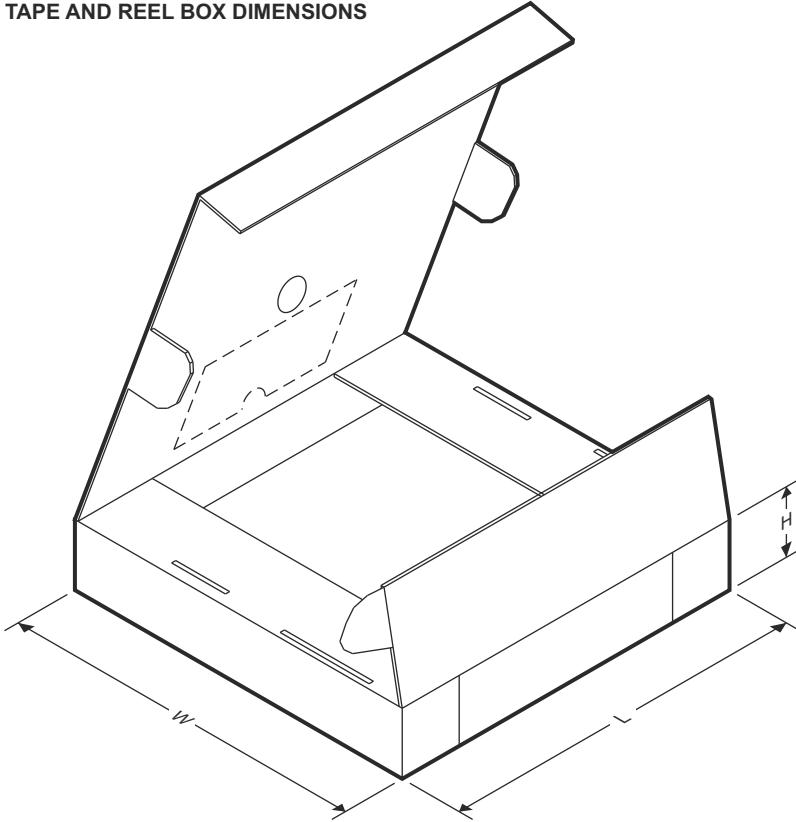

Device	Package Type	Package Drawing	Pins	SPQ	Length (mm)	Width (mm)	Height (mm)
ESD341DPLR	X2SON	DPL	2	15000	205	200	33

PACKAGING INFORMATION

Orderable Device	Status (1)	Package Type	Package Drawing	Pins	Package Qty	Eco Plan (2)	Lead finish/ Ball material (6)	MSL Peak Temp (3)	Op Temp (°C)	Device Marking (4/5)	Samples
ESD341DPLR	ACTIVE	X2SON	DPL	2	15000	RoHS & Green	NIPDAU	Level-1-260C-UNLIM	-40 to 125	3	Samples

(1) The marketing status values are defined as follows:

ACTIVE: Product device recommended for new designs.

LIFEBUY: TI has announced that the device will be discontinued, and a lifetime-buy period is in effect.

NRND: Not recommended for new designs. Device is in production to support existing customers, but TI does not recommend using this part in a new design.

PREVIEW: Device has been announced but is not in production. Samples may or may not be available.

OBSELETE: TI has discontinued the production of the device.

(2) **RoHS:** TI defines "RoHS" to mean semiconductor products that are compliant with the current EU RoHS requirements for all 10 RoHS substances, including the requirement that RoHS substance do not exceed 0.1% by weight in homogeneous materials. Where designed to be soldered at high temperatures, "RoHS" products are suitable for use in specified lead-free processes. TI may reference these types of products as "Pb-Free".

RoHS Exempt: TI defines "RoHS Exempt" to mean products that contain lead but are compliant with EU RoHS pursuant to a specific EU RoHS exemption.

Green: TI defines "Green" to mean the content of Chlorine (Cl) and Bromine (Br) based flame retardants meet JS709B low halogen requirements of <=1000ppm threshold. Antimony trioxide based flame retardants must also meet the <=1000ppm threshold requirement.

(3) MSL, Peak Temp. - The Moisture Sensitivity Level rating according to the JEDEC industry standard classifications, and peak solder temperature.

(4) There may be additional marking, which relates to the logo, the lot trace code information, or the environmental category on the device.

(5) Multiple Device Markings will be inside parentheses. Only one Device Marking contained in parentheses and separated by a "-" will appear on a device. If a line is indented then it is a continuation of the previous line and the two combined represent the entire Device Marking for that device.

(6) Lead finish/Ball material - Orderable Devices may have multiple material finish options. Finish options are separated by a vertical ruled line. Lead finish/Ball material values may wrap to two lines if the finish value exceeds the maximum column width.

Important Information and Disclaimer:The information provided on this page represents TI's knowledge and belief as of the date that it is provided. TI bases its knowledge and belief on information provided by third parties, and makes no representation or warranty as to the accuracy of such information. Efforts are underway to better integrate information from third parties. TI has taken and continues to take reasonable steps to provide representative and accurate information but may not have conducted destructive testing or chemical analysis on incoming materials and chemicals. TI and TI suppliers consider certain information to be proprietary, and thus CAS numbers and other limited information may not be available for release.

In no event shall TI's liability arising out of such information exceed the total purchase price of the TI part(s) at issue in this document sold by TI to Customer on an annual basis.

IMPORTANT NOTICE AND DISCLAIMER

TI PROVIDES TECHNICAL AND RELIABILITY DATA (INCLUDING DATA SHEETS), DESIGN RESOURCES (INCLUDING REFERENCE DESIGNS), APPLICATION OR OTHER DESIGN ADVICE, WEB TOOLS, SAFETY INFORMATION, AND OTHER RESOURCES "AS IS" AND WITH ALL FAULTS, AND DISCLAIMS ALL WARRANTIES, EXPRESS AND IMPLIED, INCLUDING WITHOUT LIMITATION ANY IMPLIED WARRANTIES OF MERCHANTABILITY, FITNESS FOR A PARTICULAR PURPOSE OR NON-INFRINGEMENT OF THIRD PARTY INTELLECTUAL PROPERTY RIGHTS.

These resources are intended for skilled developers designing with TI products. You are solely responsible for (1) selecting the appropriate TI products for your application, (2) designing, validating and testing your application, and (3) ensuring your application meets applicable standards, and any other safety, security, regulatory or other requirements.

These resources are subject to change without notice. TI grants you permission to use these resources only for development of an application that uses the TI products described in the resource. Other reproduction and display of these resources is prohibited. No license is granted to any other TI intellectual property right or to any third party intellectual property right. TI disclaims responsibility for, and you will fully indemnify TI and its representatives against, any claims, damages, costs, losses, and liabilities arising out of your use of these resources.

TI's products are provided subject to [TI's Terms of Sale](#) or other applicable terms available either on ti.com or provided in conjunction with such TI products. TI's provision of these resources does not expand or otherwise alter TI's applicable warranties or warranty disclaimers for TI products.

TI objects to and rejects any additional or different terms you may have proposed.

Mailing Address: Texas Instruments, Post Office Box 655303, Dallas, Texas 75265
Copyright © 2022, Texas Instruments Incorporated