

THE INFORMATION CONTAINED IN THIS DRAWING IS THE SOLE PROPERTY OF L-COM, INC. ANY REPRODUCTION IN PART OR WHOLE WITHOUT THE WRITTEN PERMISSION OF L-COM, INC. IS PROHIBITED.

MATERIAL LIST

ITEM	DESCRIPTION	MATERIAL	PLATING/COLOR	QTY
1	HOUSING	THERMOPLASTIC	UL94 V-0, BLACK	1
2	SPRING	SUS	NA	1
3	SHORT CONTACT	COPPER ALLOY	GOLD FLASH	4
4	SHIELD TUBE	COPPER ALLOY	NICKEL	1
5	O-RING	SILICA GEL	BLACK	1
6	LONG CONTACT	COPPER ALLOY	GOLD FLASH	1
7	SHELL	BRASS	NICKEL	1

REVISIONS			
REV	DESCRIPTION	DATE	APPROVED
A	INITIAL RELEASE	12/31/2021	GUTTA DAURO

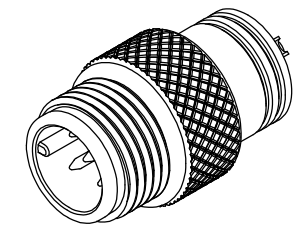
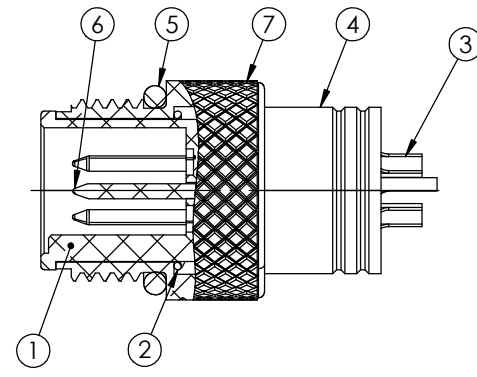
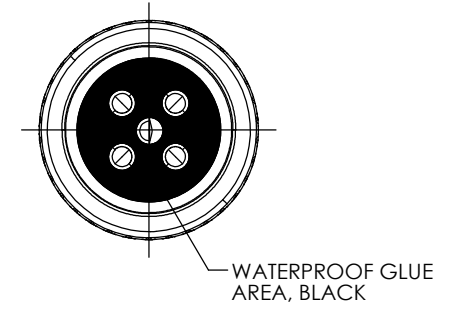
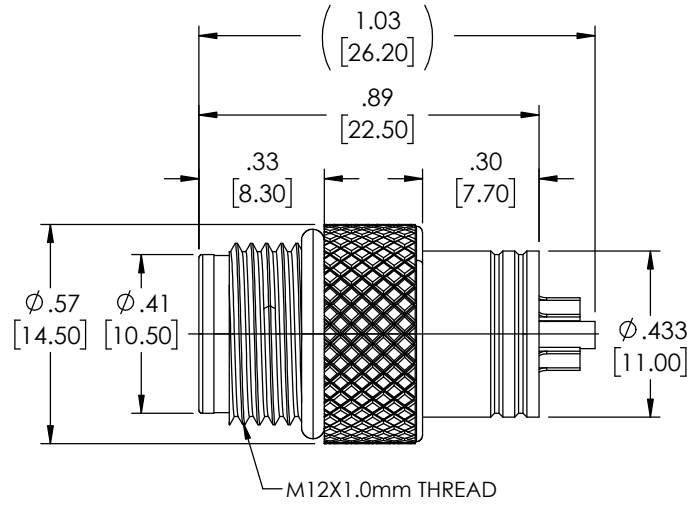
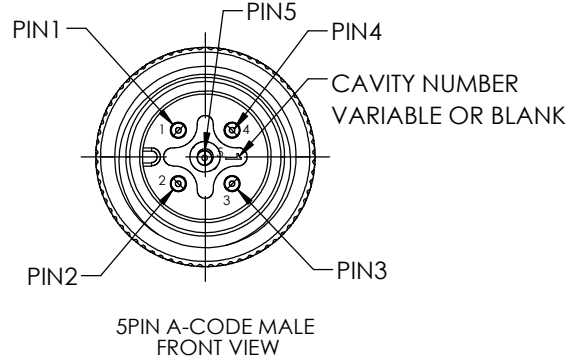

NOTES

MATERIAL
SEE MATERIAL LIST

ELECTRICAL
CURRENT RATING: 4 A
VOLTAGE: 60VAC
CONTACT RESISTANCE: 10mΩ MAX
INSULATION RESISTANCE: 100MΩ MIN

ENVIRONMENT
OPERATING TEMPERATURE: -25~+85°C

APPLICATION
CONNECTOR MEET IEC 61076-2-101 STANDARD
INGRESS PROTECTION RATING IS IP67

MISCELLANEOUS:
CONNECTOR SHALL BE INDIVIDUALLY PACKAGED IN ACCORDANCE WITH L-COM SPECIFICATION PS-0031.

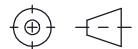
UNLESS OTHERWISE SPECIFIED, DIMENSIONS ARE IN INCHES [mm] OVERALL CABLE LENGTH TOLERANCE: ≤12 [305] = +1 [25] / -0 >12 [305] ≤60 [1524] = +2 [51] / -0 >60 [1524] ≤120 [3048] = +4 [102] / -0 >120 [3048] ≤300 [7620] = +6 [152] / -0 >300 [7620] = +5% / -0 ALL OTHER DIMENSIONAL TOLERANCES: .X = ± .2 [5] FRACTIONS ± 1/32 .XX = ± .02 [.5] ANGLES ± 1° .XXX = ± .005 [.13]	APPROVALS	DATE	 50 High Street, West Mill, North Andover, MA 01845 USA. Phone: 1.800.341.5266 1.978.682.6936
	DRAWN BY BZHANG	10/15/2021	
THIRD-ANGLE PROJECTION 	CHECKED BY GUTTA DAURO	10/15/2021	TELECOM/MODULAR PRODUCT DESCRIPTION M12 5P A-CODE MOLD CONNECTOR, MALE, SHLD
	APPROVED BY GUTTA DAURO	10/15/2021	
CONFIGURATION DETAILS OF UNDIMENSIONED FEATURES MAY VARY	COLOR VARIATIONS MAY OCCUR	SIZE A CAGE CODE 43321 DWG. NO. M125AM-MLD REV. A	SCALE: NONE CAD FILE: M125AM-MLD.SLDDRW SHEET 1 OF 1