



Single/Dual/Quad, Low-Cost, SOT23, Low-Power, Rail-to-Rail I/O Op Amps

General Description

The MAX4322/MAX4323/MAX4326/MAX4327/MAX4329 family of operational amplifiers combines wide bandwidth and excellent DC accuracy with Rail-to-Rail® operation at the inputs and outputs. These devices require only 650µA per amplifier and operate from either a single supply (+2.4V to +6.5V) or dual supplies ($\pm 1.2V$ to $\pm 3.25V$). These unity-gain-stable amplifiers are capable of driving 250Ω loads and have a 5MHz gain-bandwidth product. The MAX4323 and MAX4327 feature a low-power shutdown mode that reduces supply current to 25µA and places the outputs in a high-impedance state.

With their rail-to-rail input common-mode range and output swing, these amplifiers are ideal for low-voltage, single-supply operation. In addition, low offset voltage and high speed make them the ideal signal-conditioning stages for precision, low-voltage data-acquisition systems. The MAX4322/MAX4323 are available in space-saving SOT23 packages.

Selector Guide

PART	BW (MHz)	NO. OF AMPS	PIN-PACKAGE	SHUTDOWN
MAX4322	5	1	5 SOT23-5, 8 µMAX/SO	—
MAX4323	5	1	8 µMAX/SO/ 6 SOT23-6	Yes
MAX4326	5	2	8 µMAX/SO	—
MAX4327	5	2	10 µMAX, 14 SO	Yes
MAX4329	5	4	14 SO	—

Applications

Battery-Powered Instruments
 Portable Equipment
 Data-Acquisition Systems
 Signal Conditioning
 Low-Power, Low-Voltage Applications

Pin Configurations appear at end of data sheet.

Rail-to-Rail is a registered trademark of Nippon Motorola, Ltd.



Features

- ◆ SOT23 Packages (MAX4322/MAX4323)
- ◆ +2.4V to +6.5V Single-Supply Operation
- ◆ Rail-to-Rail Input Common-Mode Voltage Range
- ◆ Rail-to-Rail Output Voltage Swing
- ◆ 5MHz Gain-Bandwidth Product
- ◆ 650µA Quiescent Current per Amplifier
- ◆ 700µV Offset Voltage
- ◆ No Phase Reversal for Overdriven Inputs
- ◆ Drive 250Ω Loads
- ◆ 25µA Shutdown Mode (MAX4323/MAX4327)
- ◆ Unity-Gain Stable for Capacitive Loads up to 500pF

Ordering Information

PART	TEMP. RANGE	PIN-PACKAGE	TOP MARK
MAX4322EUK-T	-40°C to +85°C	5 SOT23-5	ACGE
MAX4322ESA	-40°C to +85°C	8 SO	—
MAX4322EUA	-40°C to +85°C	8 µMAX	—
MAX4323ESA	-40°C to +85°C	8 SO	—
MAX4323EUA	-40°C to +85°C	8 µMAX	—
MAX4323EUT	-40°C to +85°C	6 SOT23-6	AAEC
MAX4326EUA	-40°C to +85°C	8 µMAX	—
MAX4326ESA	-40°C to +85°C	8 SO	—
MAX4327EUB	-40°C to +85°C	10 µMAX	—
MAX4327ESD	-40°C to +85°C	14 SO	—
MAX4329ESD	-40°C to +85°C	14 SO	—

Typical Operating Circuit

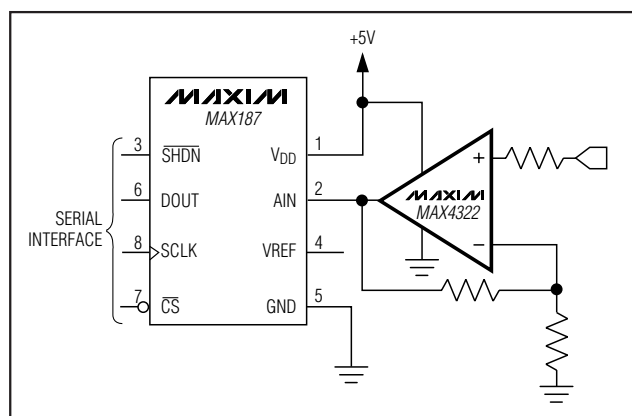

MAX4322/MAX4323/MAX4326/MAX4327/MAX4329

Single/Dual/Quad, Low-Cost, SOT23, Low-Power, Rail-to-Rail I/O Op Amps

ABSOLUTE MAXIMUM RATINGS

Supply Voltage (VCC-VEE)+7.5V
 All Other Pins(VCC + 0.3V) to (VEE - 0.3V)
 Output Short-Circuit Duration.....Continuous
 (short to either supply)
 Continuous Power Dissipation (TA = +70°C)
 5-pin SOT23-5 (derate 7.1mW/°C above +70°C)571mW
 6-pin SOT23 (derate 7.1mW/°C Above + 70°C)571mW
 8-pin SO (derate 5.88mW/°C above +70°C).....471mW
 8-pin μMAX (derate 4.10mW/°C above +70°C)330mW
 10-pin μMAX (derate 5.6mW/°C above +70°C)444mW
 14-pin SO (derate 8.00mW/°C above +70°C).....640mW

Operating Temperature Range
 MAX432_E__-40°C to +85°C
 Maximum Junction Temperature+150°C
 Storage Temperature Range-65°C to +160°C
 Lead Temperature (soldering, 10sec).....+300°C

Stresses beyond those listed under "Absolute Maximum Ratings" may cause permanent damage to the device. These are stress ratings only, and functional operation of the device at these or any other conditions beyond those indicated in the operational sections of the specifications is not implied. Exposure to absolute maximum rating conditions for extended periods may affect device reliability.

DC ELECTRICAL CHARACTERISTICS—TA = +25°C

(VCC = +5.0V, VEE = 0, VCM = 0, VOUT = VCC / 2, $\overline{\text{SHDN}}$ = VCC, RL tied to VCC / 2, unless otherwise noted.)

PARAMETER	CONDITIONS		MIN	TYP	MAX	UNITS
Input Offset Voltage	VCM = VEE, VCC	MAX432_ESA/MAX4327ESD		±0.7	±2.0	mV
		All other packages		±1.2	±2.50	
Input Bias Current	VCM = VEE, VCC			±50	±150	nA
Input Offset Current	VCM = VEE, VCC			±1	±12	nA
Differential Input Resistance	-1.5V < VDIFF < 1.5V			500		kΩ
Common-Mode Input Voltage Range	Inferred from CMRR test		VEE		VCC	V
Common-Mode Rejection Ratio	VEE ≤ VCM ≤ VCC	MAX432_ESA/MAX4327ESD	62	94		dB
		All other packages	60	91		
Power-Supply Rejection Ratio	VCC = 2.4V to 6.5V		66	100		dB
Output Resistance	AV = +1V/V			0.1		Ω
Large-Signal Voltage Gain	VOUT = 0.25V to 4.75V, RL = 100kΩ			106		dB
	VOUT = 0.4V to 4.6V, RL = 250Ω		70	86		

Single/Dual/Quad, Low-Cost, SOT23, Low-Power, Rail-to-Rail I/O Op Amps

MAX4322/MAX4323/MAX4326/MAX4327/MAX4329

DC ELECTRICAL CHARACTERISTICS— $T_A = +25^\circ\text{C}$ (continued)

($V_{CC} = +5\text{V}$, $V_{EE} = 0$, $V_{CM} = 0$, $V_{OUT} = V_{CC} / 2$, $\overline{\text{SHDN}} = V_{CC}$, R_L tied to $V_{CC} / 2$, unless otherwise noted.)

PARAMETER	CONDITIONS		MIN	TYP	MAX	UNITS
Output Voltage Swing	MAX4322/ MAX4323	$R_L = 100\text{k}\Omega$	$V_{CC} - V_{OH}$	12		mV
			$V_{OL} - V_{EE}$	20		
		$R_L = 250\Omega$	$V_{CC} - V_{OH}$	200	300	
			$V_{OL} - V_{EE}$	100	200	
	MAX4326/ MAX4327/ MAX4329	$R_L = 100\text{k}\Omega$	$V_{CC} - V_{OH}$	15		
			$V_{OL} - V_{EE}$	25		
		$R_L = 250\Omega$	$V_{CC} - V_{OH}$	220	350	
			$V_{OL} - V_{EE}$	120	250	
Output Short-Circuit Current			50			mA
$\overline{\text{SHDN}}$ Logic Threshold	MAX4323/MAX4327		Low		0.8	V
			High	2.0		
$\overline{\text{SHDN}}$ Input Current	MAX4323/MAX4327			± 1	± 4	μA
Operating Supply-Voltage Range	Inferred from PSRR test		2.4		6.5	V
Supply Current per Amplifier	$V_{CM} = V_{OUT} = V_{CC} / 2$		$V_{CC} = 2.4\text{V}$	650		μA
			$V_{CC} = 5\text{V}$	725	1100	
Shutdown Supply Current per Amplifier	$\overline{\text{SHDN}} > 0.8\text{V}$, MAX4323/MAX4327		$V_{CC} = 2.4\text{V}$	25		μA
			$V_{CC} = 5\text{V}$	40	60	

DC ELECTRICAL CHARACTERISTICS— $T_A = -40^\circ\text{C}$ to $+85^\circ\text{C}$

($V_{CC} = +5\text{V}$, $V_{EE} = 0$, $V_{CM} = 0$, $V_{OUT} = V_{CC} / 2$, $\overline{\text{SHDN}} = V_{CC}$, R_L tied to $V_{CC} / 2$, unless otherwise noted.) (Note 1)

PARAMETER	CONDITIONS		MIN	TYP	MAX	UNITS
Input Offset Voltage	$V_{CM} = V_{EE}, V_{CC}$	MAX432_ESA/MAX4327ESD			± 3.0	mV
		All other packages			± 6.0	
Input Offset Voltage Tempco				± 2		$\mu\text{V}/^\circ\text{C}$
Input Bias Current	$V_{CM} = V_{EE}, V_{CC}$				± 180	nA
Input Offset Current	$V_{CM} = V_{EE}, V_{CC}$				± 20	nA
Common-Mode Input Voltage Range	Inferred from CMRR test		V_{EE}		V_{CC}	V
Common-Mode Rejection Ratio	$V_{EE} \leq V_{CM} \leq V_{CC}$	MAX432_ESA/MAX4327ESD	59			dB
		All other packages	54			

Single/Dual/Quad, Low-Cost, SOT23, Low-Power, Rail-to-Rail I/O Op Amps

DC ELECTRICAL CHARACTERISTICS — $T_A = -40^{\circ}\text{C}$ to $+85^{\circ}\text{C}$ (continued)

($V_{CC} = +5\text{V}$, $V_{EE} = 0$, $V_{CM} = 0$, $V_{OUT} = V_{CC} / 2$, $\overline{\text{SHDN}} = V_{CC}$, R_L tied to $V_{CC} / 2$, unless otherwise noted.) (Note 1)

PARAMETER	CONDITIONS		MIN	TYP	MAX	UNITS
Power-Supply Rejection Ratio	$V_{CC} = 2.4\text{V}$ to 6.5V		62			dB
Large-Signal Voltage Gain	$V_{OUT} = 0.4\text{V}$ to 4.6V , $R_L = 250\Omega$		66			dB
Output Voltage Swing	MAX4322/ MAX4323	$R_L = 250\Omega$	$V_{CC} - V_{OH}$		350	mV
			$V_{OL} - V_{EE}$		250	
	MAX4326/ MAX4327/ MAX4329	$R_L = 250\Omega$	$V_{CC} - V_{OH}$		400	
			$V_{OL} - V_{EE}$		300	
$\overline{\text{SHDN}}$ Logic Threshold	MAX4323/MAX4327		Low		0.8	V
			High	2.0		
$\overline{\text{SHDN}}$ Input Current	MAX4323/MAX4327				± 5	μA
Operating Supply-Voltage Range			2.4		6.5	V
Supply Current per Amplifier	$V_{CM} = V_{CC} / 2$				1.2	mA
Shutdown Supply Current per Amplifier	$\overline{\text{SHDN}} \leq 0.8\text{V}$, MAX4323/MAX4327				70	μA

AC ELECTRICAL CHARACTERISTICS

($V_{CC} = +5\text{V}$, $V_{EE} = 0$, $V_{CM} = V_{OUT} = V_{CC} / 2$, $\overline{\text{SHDN}} = V_{CC}$, $T_A = +25^{\circ}\text{C}$ unless otherwise noted.)

PARAMETER	CONDITIONS		MIN	TYP	MAX	UNITS
Gain-Bandwidth Product				5		MHz
Phase Margin				64		degrees
Gain Margin				12		dB
Total Harmonic Distortion	$f = 10\text{kHz}$, $V_{OUT} = 2\text{Vp-p}$, $A_V = +1\text{V/V}$			0.003		%
Slew Rate				2		$\text{V}/\mu\text{s}$
Settling Time to 0.01%	$A_V = +1\text{V/V}$, $V_{OUT} = 2\text{V}$ step			2.0		μs
Turn-On Time	$V_{CC} = 0$ to 3V step			1		μs
$\overline{\text{SHDN}}$ Delay	MAX4323/MAX4327		Enable	1		μs
			Disable	0.2		
Input Capacitance				3		pF
Input Noise Voltage Density	$f = 1\text{kHz}$			22		$\text{nV}/\sqrt{\text{Hz}}$
Input Noise Current Density	$f = 1\text{kHz}$			0.4		pA
Amp-Amp Isolation				135		dB
Capacitive Load Stability	$A_V = +1\text{V/V}$			250		pF

Note 1: All devices are 100% tested at $T_A = +25^{\circ}\text{C}$. All temperature limits are guaranteed by design.

Single/Dual/Quad, Low-Cost, SOT23, Low-Power, Rail-to-Rail I/O Op Amps

Typical Operating Characteristics

($V_{CC} = +5V$, $V_{EE} = 0$, $V_{CM} = V_{CC} / 2$, $\overline{SHDN} = V_{CC}$, $T_A = +25^\circ C$, unless otherwise noted.)

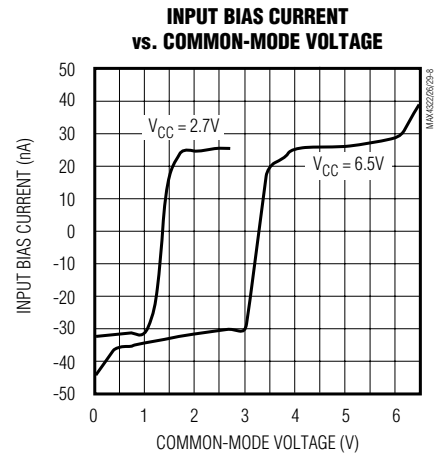
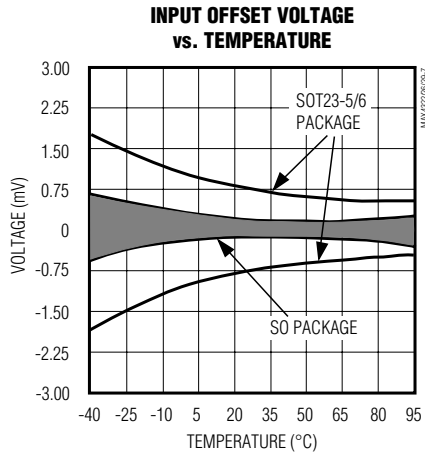
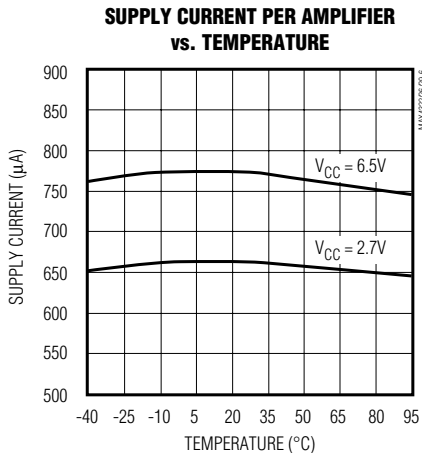
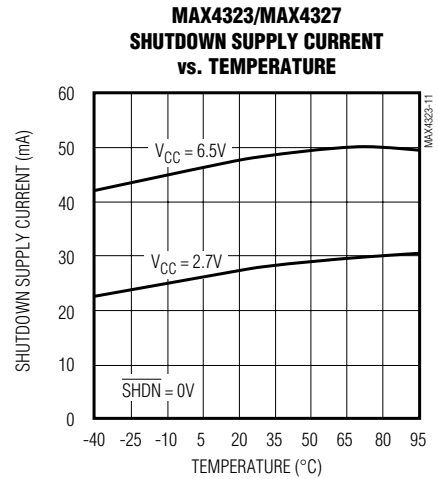
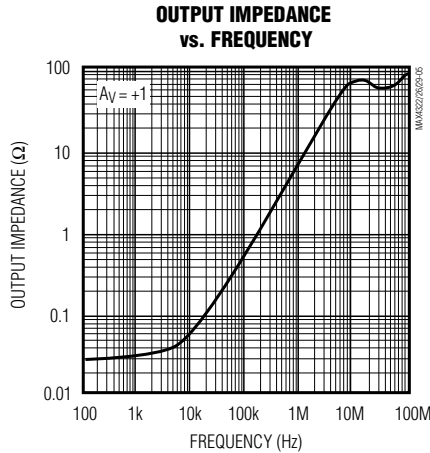
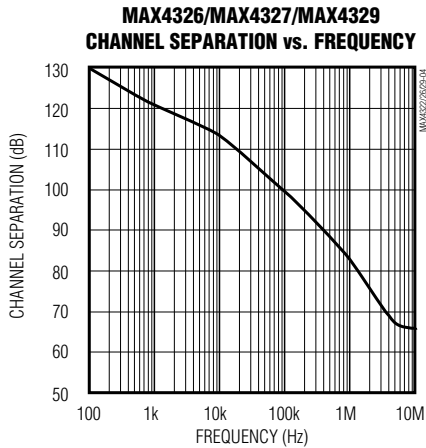
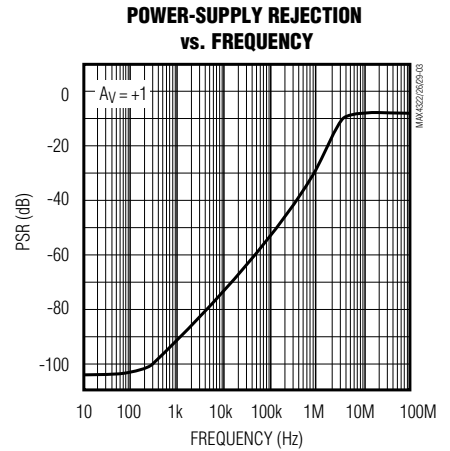
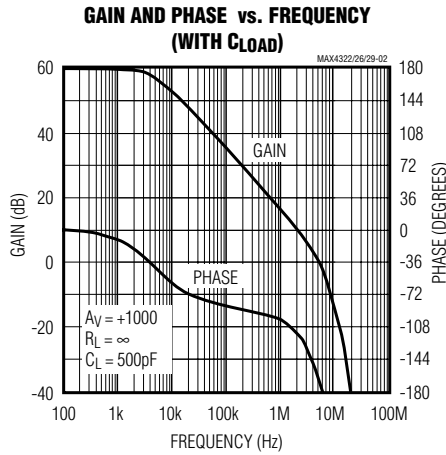
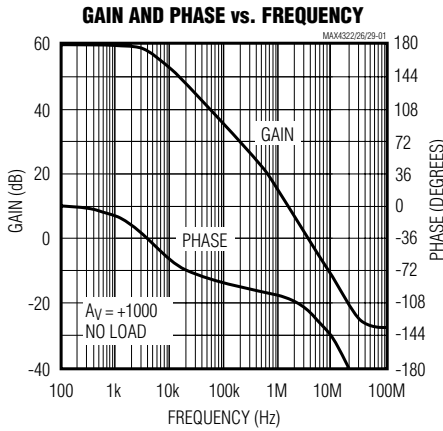

Single/Dual/Quad, Low-Cost, SOT23, Low-Power, Rail-to-Rail I/O Op Amps

Typical Operating Characteristics (continued)

($V_{CC} = +5V$, $V_{EE} = 0$, $V_{CM} = V_{CC} / 2$, $\overline{SHDN} = V_{CC}$, $T_A = +25^\circ C$, unless otherwise noted.)

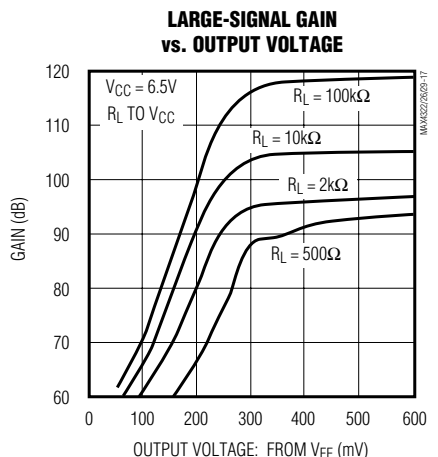
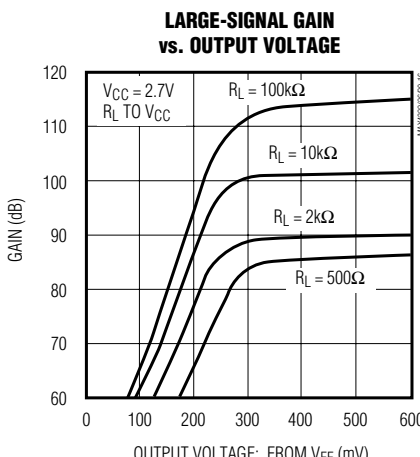
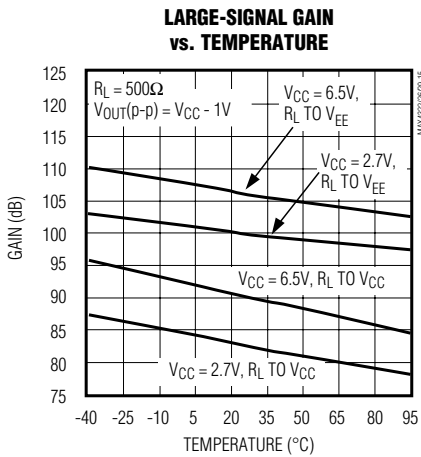
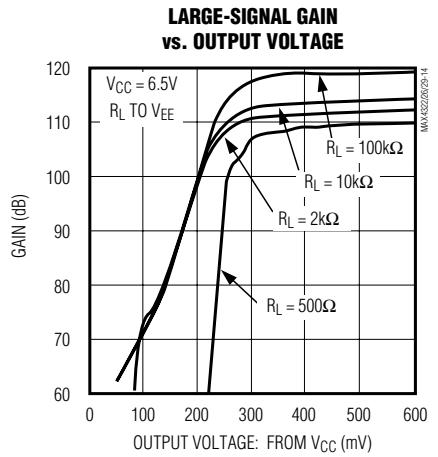
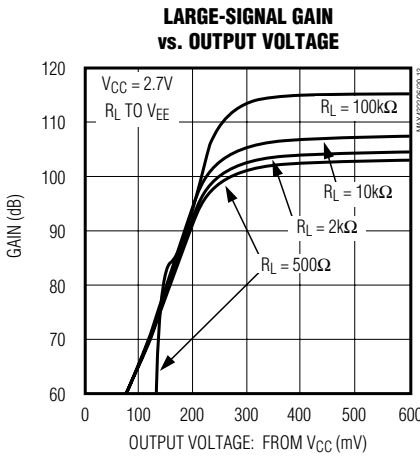
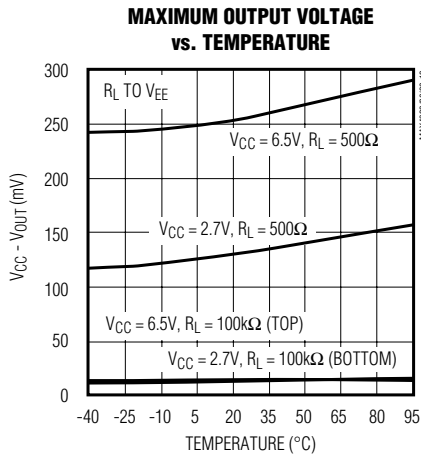
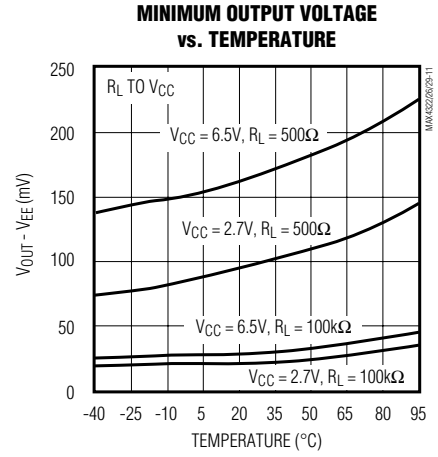
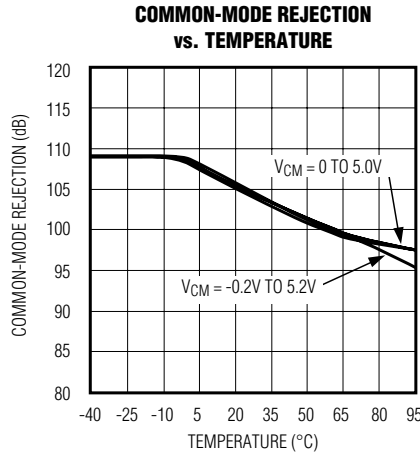
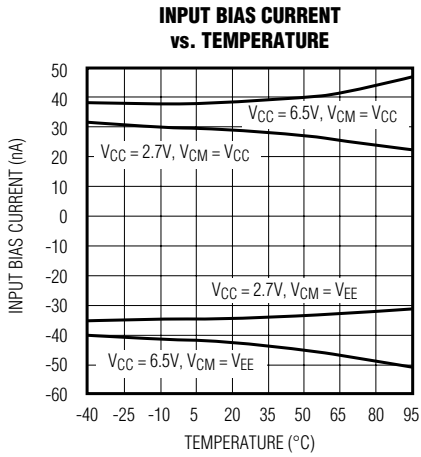

Single/Dual/Quad, Low-Cost, SOT23, Low-Power, Rail-to-Rail I/O Op Amps

Typical Operating Characteristics (continued)

($V_{CC} = +5V$, $V_{EE} = 0$, $V_{CM} = V_{CC} / 2$, $\overline{SHDN} = V_{CC}$, $T_A = +25^\circ C$, unless otherwise noted.)

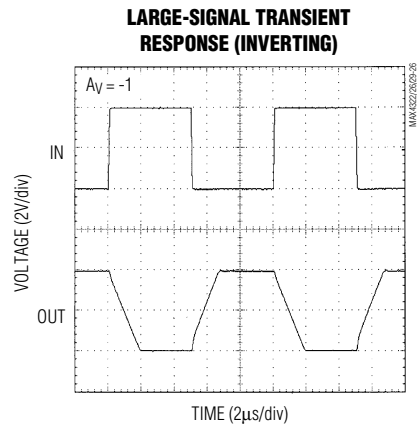
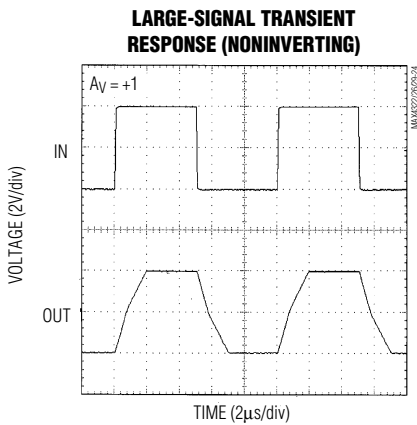
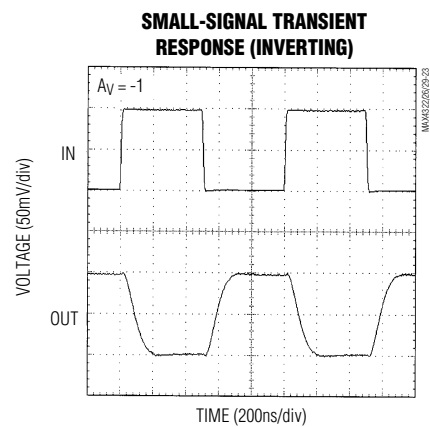
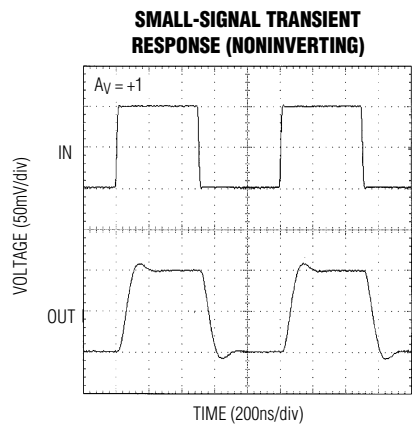
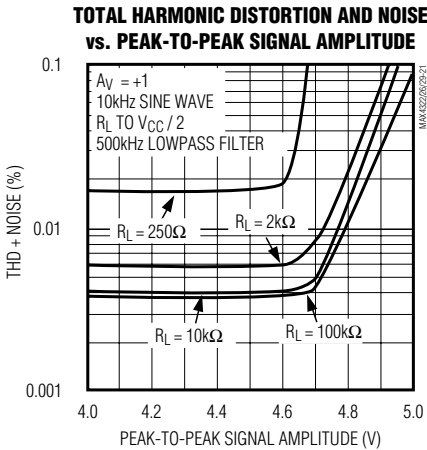
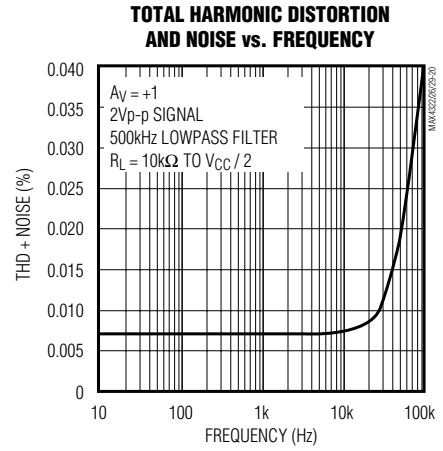
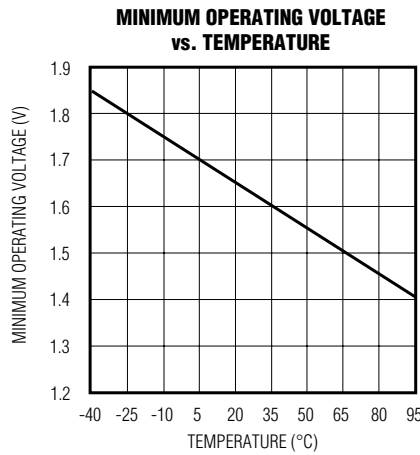
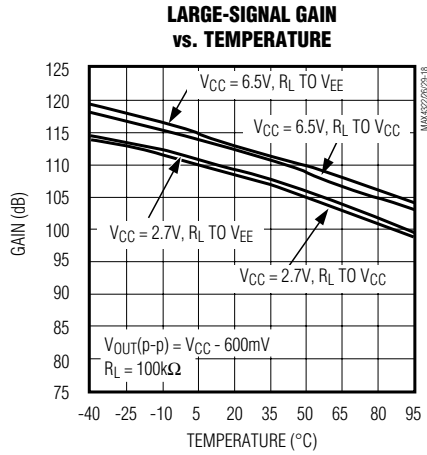

Single/Dual/Quad, Low-Cost, SOT23, Low-Power, Rail-to-Rail I/O Op Amps

Pin Description

PIN								NAME	FUNCTION
MAX4322		MAX4323		MAX4326	MAX4327		MAX4329		
SOT23-5	SO/ μ MAX	SOT23-6	SO/ μ MAX		μ MAX	SO			
1	6	1	6	—	—	—	—	OUT	Output
2	4	2	4	4	4	4	11	V _{EE}	Negative Supply. Ground for single-supply operation.
3	—	3	—	—	—	—	—	IN+	Noninverting Input
4	—	4	—	—	—	—	—	IN-	Inverting Input
5	7	6	7	8	10	14	4	V _{CC}	Positive Supply
—	1, 5, 8	—	1, 5	—	—	5, 7, 8, 10	—	N.C.	No Connection
—	—	5	8	—	—	—	—	$\overline{\text{SHDN}}$	Shutdown Control. Tie high or leave floating to enable amplifier.
—	—	—	—	1, 7	1, 9	1, 13	1, 7	OUT1, OUT2	Outputs for amps 1 and 2
—	2	—	2	2, 6	2, 8	2, 12	2, 6	IN1-, IN2-	Inverting Inputs for amps 1 and 2
—	3	—	3	3, 5	3, 7	3, 11	3, 5	IN1+, IN2+	Noninverting Inputs for amps 1 and 2
—	—	—	—	—	5, 6	5, 9	—	$\overline{\text{SHDN1}}$, $\overline{\text{SHDN2}}$	Shutdown Control for amps 1 and 2. Tie high or leave floating to enable amplifier.
—	—	—	—	—	—	—	8, 14	OUT3, OUT4	Outputs for amps 3 and 4
—	—	—	—	—	—	—	9, 13	IN3-, IN4-	Inverting Inputs for amps 3 and 4
—	—	—	—	—	—	—	10, 12	IN3+, IN4+	Noninverting Inputs for amps 3 and 4

Applications Information

Rail-to-Rail Input Stage

Devices in the MAX4322/MAX4323/MAX4326/MAX4327/MAX4329 family of high-speed amplifiers have rail-to-rail input and output stages designed for low-voltage, single-supply operation. The input stage consists of separate NPN and PNP differential stages, which combine to provide an input common-mode range extending to the supply rails. The PNP stage is active for input voltages close to the negative rail, and the NPN stage is active for input voltages near the positive rail. The input offset voltage is typically below 250 μ V. The

switchover transition region, which occurs near $V_{CC} / 2$, has been extended to minimize the slight degradation in CMRR caused by the mismatch of the input pairs. Their low offset voltage, high bandwidth, and rail-to-rail common-mode range make these op amps excellent choices for precision, low-voltage, data-acquisition systems.

Since the input stage switches between the NPN and PNP pairs, the input bias current changes polarity as the input voltage passes through the transition region. To reduce the offset error caused by input bias currents flowing through external source impedances, match the effective impedance seen by each input (Figures 1a, 1b). High source impedances, together

Single/Dual/Quad, Low-Cost, SOT23, Low-Power, Rail-to-Rail I/O Op Amps

MAX4322/MAX4323/MAX4326/MAX4327/MAX4329

with the input capacitance, can create a parasitic pole that produces an underdamped signal response. Reducing the input impedance or placing a small (2pF to 10pF) capacitor across the feedback resistor improves the response.

The MAX4322/MAX4323/MAX4326/MAX4327/MAX4329's inputs are protected from large differential input voltages by 1kΩ series resistors and back-to-back triple diodes across the inputs (Figure 2). For differential input voltages less than 1.8V the input resistance is typically 500kΩ. For differential input voltages greater than 1.8V the input resistance is approximately 2kΩ, and the input bias current is determined by the following equation:

$$I_{BIAS} = \frac{V_{DIFF} - 1.8V}{2k\Omega}$$

Rail-to-Rail Output Stage

The minimum output voltage will be within millivolts of ground for single-supply operation where the load is referenced to ground (VEE). Figure 3 shows the input voltage range and output voltage swing of a MAX4322 connected as a voltage follower. With a +3V supply and the load tied to ground, the output swings from 0.00V to 2.90V. The maximum output voltage swing depends on the load, but will be within 350mV of a +5V supply, even with the maximum load (500Ω to ground).

Driving a capacitive load can cause instability in most high-speed op amps, especially those with low quiescent current. The MAX4322/MAX4323/MAX4326/MAX4327/MAX4329 have a high tolerance for capacitive loads. They are stable with capacitive loads up to 500pF. Figure 4 gives the stable operating region for capacitive loads. Figures 5 and 6 show the response with capacitive loads and the results of adding an isolation resistor in series with the output (Figure 7). The resistor improves the circuit's phase margin by isolating the load capacitor from the op amp's output.

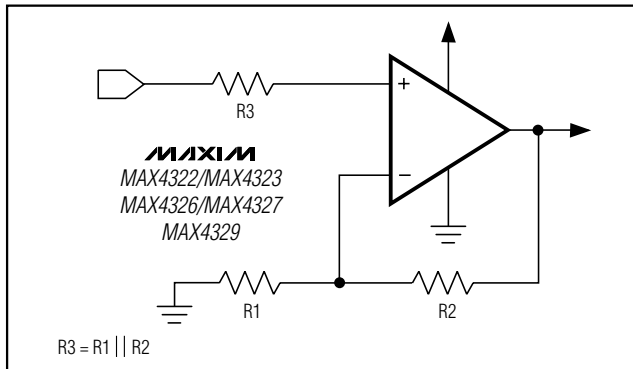

Figure 1a. Reducing Offset Error Due to Bias Current (Noninverting)

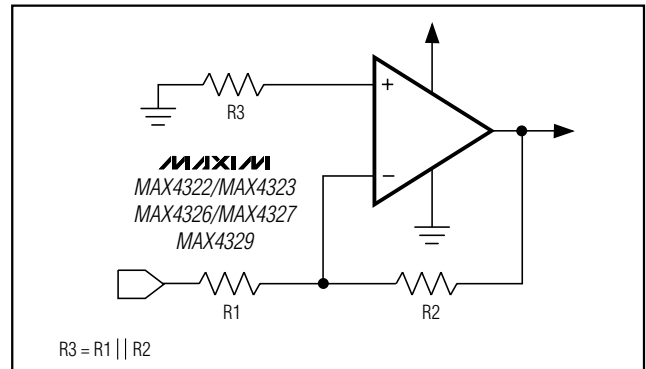

Figure 1b. Reducing Offset Error Due to Bias Current (Inverting)

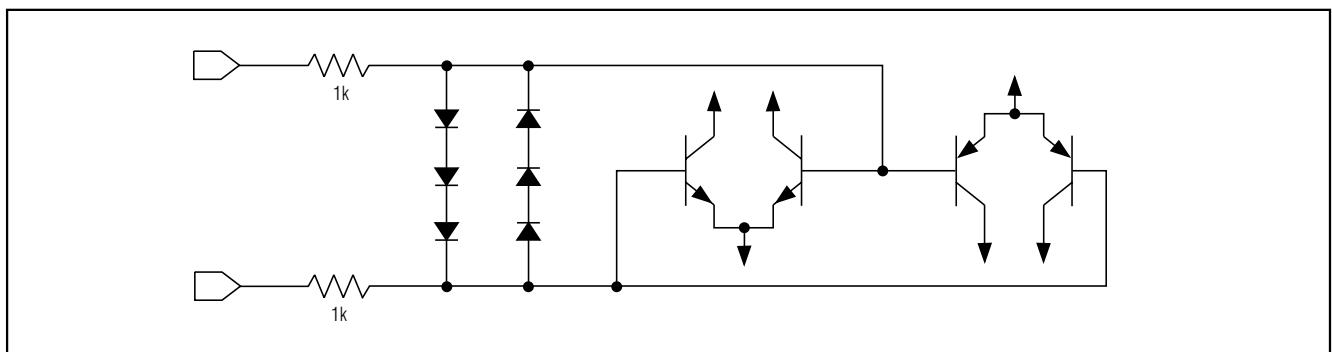

Figure 2. Input Protection Circuit

Single/Dual/Quad, Low-Cost, SOT23, Low-Power, Rail-to-Rail I/O Op Amps

Power-Up and Shutdown Mode

The MAX4322/MAX4323/MAX4326/MAX4327/MAX4329 amplifiers typically settle within 1 μ s after power-up. Using the test circuit of Figure 8, Figures 9 and 10 show the output voltage and supply current on power-up.

The MAX4323 and MAX4327 have a shutdown option. When the shutdown pin (SHDN) is pulled low, the supply current drops below 25 μ A per amplifier and the amplifiers are disabled with the outputs in a high-impedance state. Pulling SHDN high or leaving it floating enables the amplifier. In the dual-amplifier MAX4327, the shutdown functions operate independently. Figures 11 and 12 show the output voltage and supply current responses of the MAX4323 to a shutdown pulse.

Power Supplies and Layout

The MAX4322/MAX4323/MAX4326/MAX4327/MAX4329 operate from a single +2.4V to +6.5V power supply, or from dual supplies of ± 1.2 V to ± 3.25 V. For single-supply operation, bypass the power supply with a 0.1 μ F ceramic capacitor in parallel with at least 1 μ F. For dual supplies, bypass each supply to ground.

Good layout improves performance by decreasing the amount of stray capacitance at the op amp's inputs and outputs. To decrease stray capacitance, minimize trace lengths and resistor leads by placing external components close to the op amp's pins.

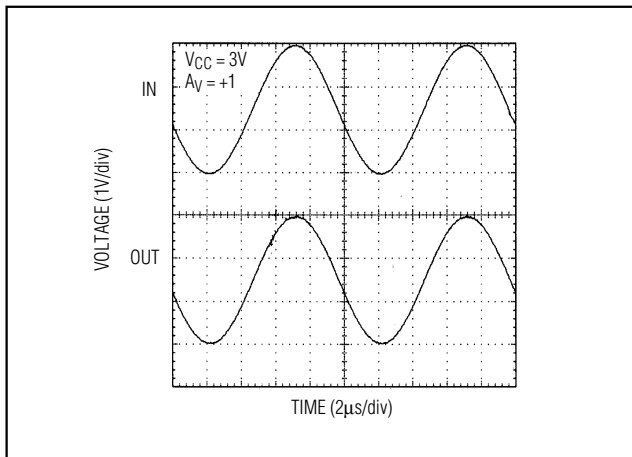

Figure 3. Rail-to-Rail Input /Output Voltage Range

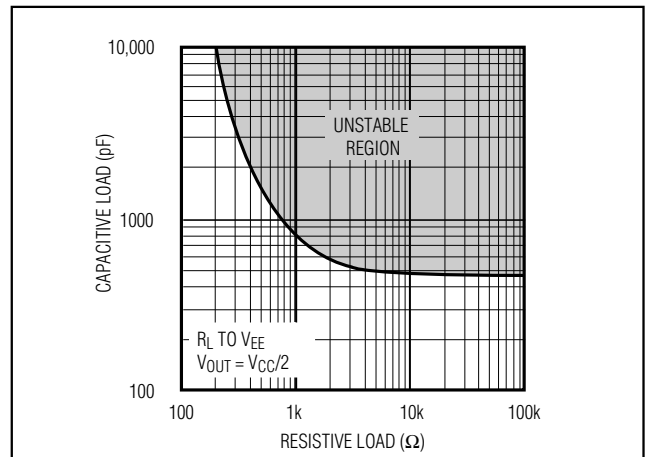

Figure 4. Capacitive-Load Stability

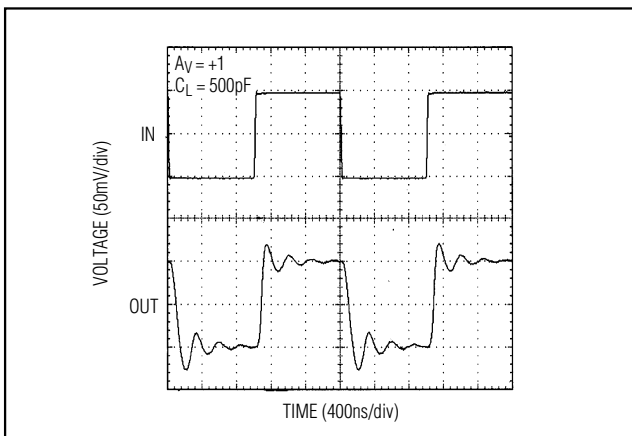

Figure 5. Small-Signal Transient Response with Capacitive Load

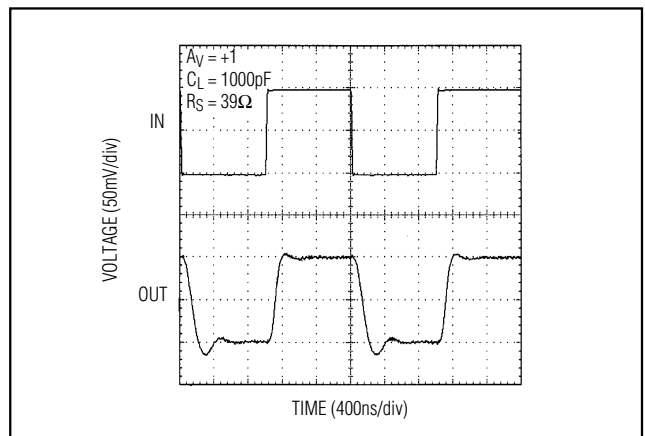

Figure 6. Transient Response to Capacitive Load with Isolation Resistor

Single/Dual/Quad, Low-Cost, SOT23, Low-Power, Rail-to-Rail I/O Op Amps

MAX4322/MAX4323/MAX4326/MAX4327/MAX4329

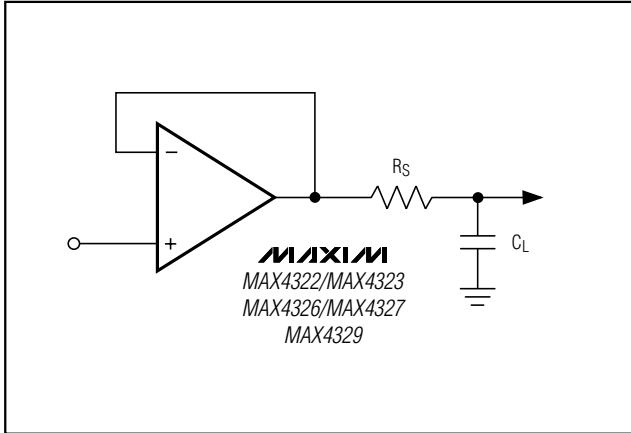

Figure 7. Capacitive-Load-Driving Circuit

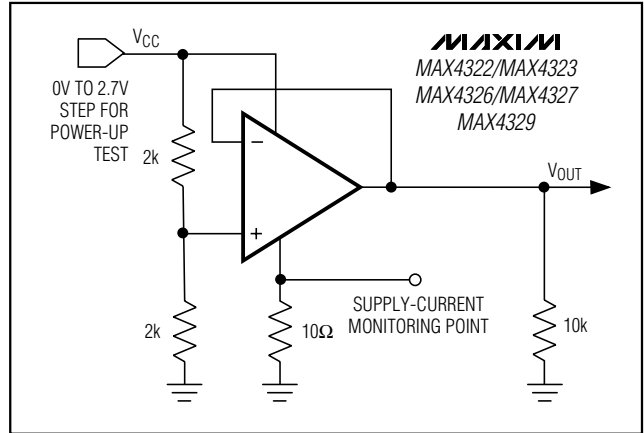

Figure 8. Power-Up Test Circuit

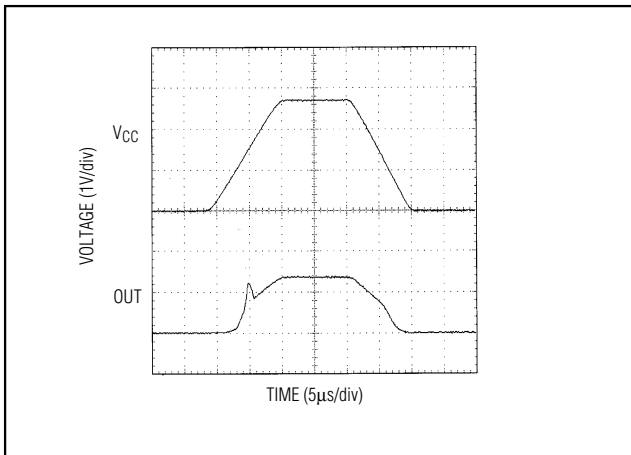

Figure 9. Power-Up Output Voltage

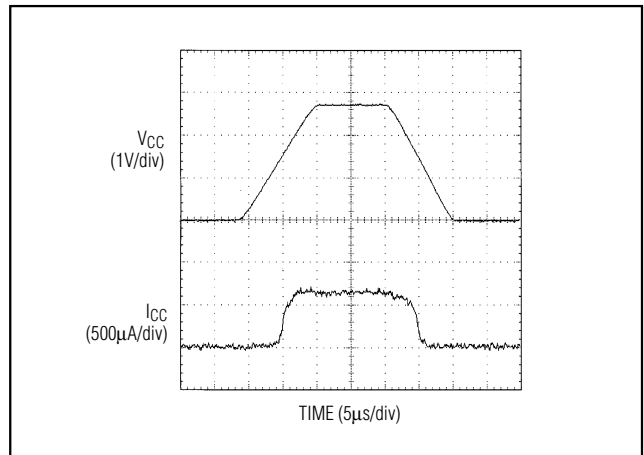

Figure 10. Power-Up Supply Current

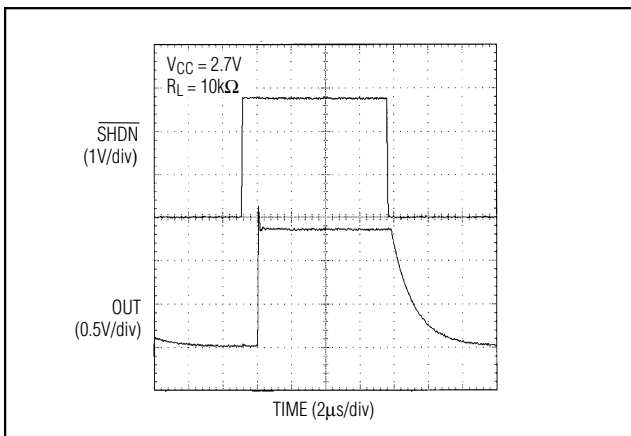

Figure 11. Shutdown Output Voltage

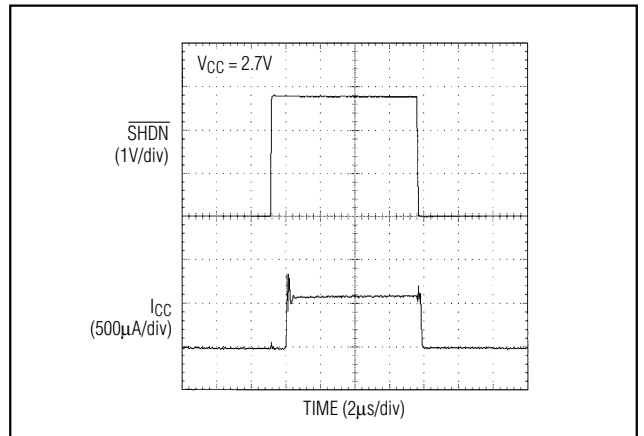
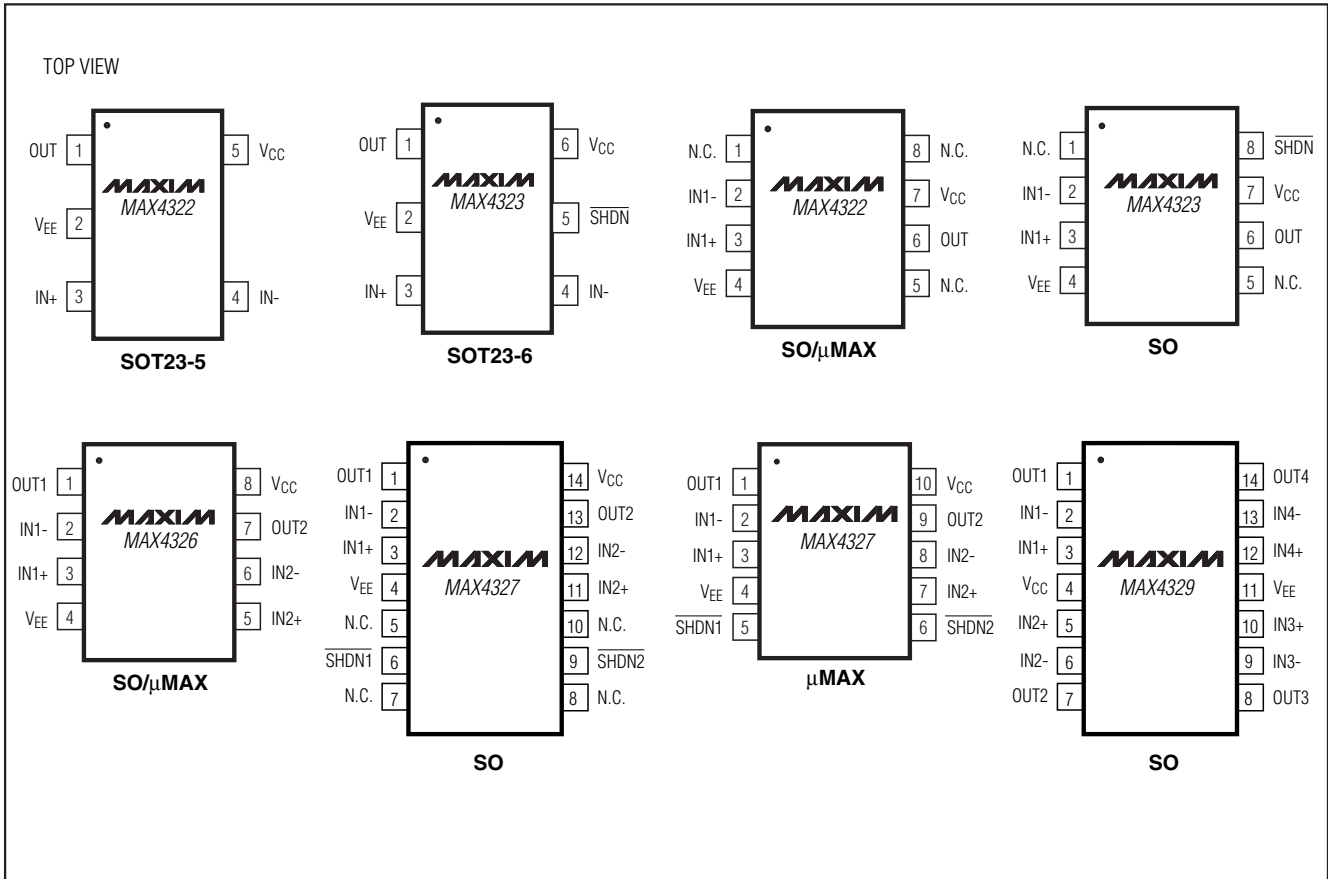

Figure 12. Shutdown Enable/Disable Supply Current

Single/Dual/Quad, Low-Cost, SOT23, Low-Power, Rail-to-Rail I/O Op Amps

Pin Configurations



Chip Information

MAX4322 TRANSISTOR COUNT: 170
 MAX4323 TRANSISTOR COUNT: 170
 MAX4326 TRANSISTOR COUNT: 340
 MAX4327 TRANSISTOR COUNT: 340
 MAX4329 TRANSISTOR COUNT: 680

SUBSTRATE CONNECTED TO VEE

Maxim cannot assume responsibility for use of any circuitry other than circuitry entirely embodied in a Maxim product. No circuit patent licenses are implied. Maxim reserves the right to change the circuitry and specifications without notice at any time.

12 **Maxim Integrated Products, 120 San Gabriel Drive, Sunnyvale, CA 94086 408-737-7600**