



Low-Cost, Remote SOT Temperature Switches

General Description

The MAX6511/MAX6512/MAX6513 are fully integrated, remote temperature switches that use an external P-N junction (typically a diode-connected transistor) as the sensing element to measure the remote temperature. These devices assert a logic signal when the temperature crosses a factory-programmed threshold. Available trip thresholds are from +45°C to +125°C in 10°C increments. Accuracy is within $\pm 3^\circ\text{C}$ ($T_A = -5^\circ\text{C}$ to $+55^\circ\text{C}$) or $\pm 5^\circ\text{C}$ ($T_A = -40^\circ\text{C}$ to $+85^\circ\text{C}$). Hysteresis is pin selectable to 5°C or 10°C.

The MAX6511 has an active-low CMOS output and the MAX6513 has an active-high CMOS output. The MAX6512 has an open-drain output. The output is asserted when the temperature exceeds the threshold value. The active-low open-drain output is intended to interface with a microprocessor (μP) reset or interrupt input. The active-high CMOS output can directly drive a power FET to control a cooling fan.

The MAX6511/MAX6512/MAX6513 operate from a +3.0V to +5.5V supply and typically consume 400 μA of supply current. They are available in the small 6-pin SOT23. The MAX6513 is also available in a 6-pin lead-free TDFN package.

Applications

CPU Temperature Monitoring in High-Speed Computers
 Multichip Modules
 Battery Packs
 Temperature Control
 Temperature Alarms
 Fan Control

Pin Configuration

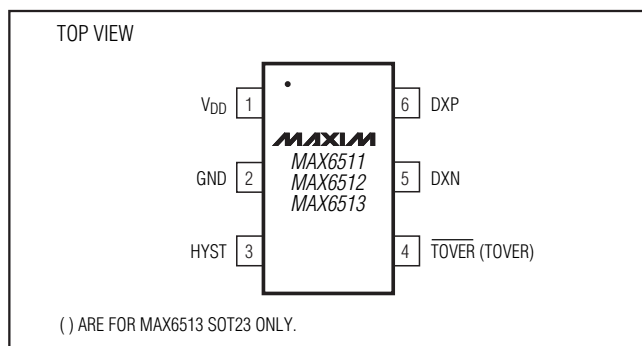

Features

- ◆ Continuously Measure External Junction Temperature
- ◆ Factory-Programmed Temperature Threshold from +45°C to +125°C in 10°C Increments
- ◆ Insensitive to Series Parasitic Resistance
- ◆ Active-Low CMOS Output (MAX6511) or Open-Drain Output for Overtemperature Alarm (MAX6512) or Active-High Output (MAX6513) for Direct Fan Control
- ◆ <100ms Response Time
- ◆ Accuracy
 - $\pm 3^\circ\text{C}$ (TREMOTE = +45°C to +125°C, $T_A = -5^\circ\text{C}$ to $+55^\circ\text{C}$)
 - $\pm 5^\circ\text{C}$ (TREMOTE = +45°C to +125°C, $T_A = -40^\circ\text{C}$ to $+85^\circ\text{C}$)
- ◆ Pin-Selectable 5°C or 10°C Hysteresis
- ◆ 400 μA Average Current Consumption
- ◆ +3.0V to +5.5V Supply Range
- ◆ 6-Pin SOT23 Package
- ◆ 6-Pin TDFN Package (Lead Free)

Ordering Information

PART*	TEMP RANGE	PIN-PACKAGE	OUTPUT
MAX6511UT___-T	-40°C to +85°C	6 SOT23-6	CMOS (active low)
MAX6512UT___-T	-40°C to +85°C	6 SOT23-6	Open-drain
MAX6513_T___-T	-40°C to +85°C	6 TDFN	CMOS
	-40°C to +85°C	6 SOT23-6	(active high)

*These parts are offered in nine standard temperature versions with a minimum order of 2500 pieces. To complete the suffix information, select an available trip point in degrees centigrade from the device marking codes table. For example, the MAX6511UT065-T describes a MAX6511 in a 6-pin SOT23 package with a +65°C threshold.

Typical Operating Circuit appears at end of data sheet.



Low-Cost, Remote SOT Temperature Switches

ABSOLUTE MAXIMUM RATINGS

Supply Voltage (V_{DD})	-0.3V to +6V
DXP, DXN, HYST, TOVER (MAX6513), TOVER (MAX6511/MAX6512)	-0.3V to ($V_{DD} + 0.3V$)
TOVER (MAX6513), TOVER (MAX6511)	
Output Current	-1mA/+50mA
DXN Input Current	-1mA/+50mA
Current (all other pins)	± 20 mA
Continuous Power Dissipation ($T_A = +70^\circ\text{C}$)	
6-Pin SOT23-6 (derate 9.1mW/ $^\circ\text{C}$ above $+70^\circ\text{C}$)	727mW
6-Pin TDFN (derate 24.4mW/ $^\circ\text{C}$ above $+70^\circ\text{C}$)	1951mW

Operating Temperature Range	-40°C to $+85^\circ\text{C}$
Storage Temperature Range	-65°C to $+150^\circ\text{C}$
Junction Temperature	$+150^\circ\text{C}$
Lead Temperature	
Vapor Phase (60s)	$+215^\circ\text{C}$
Infrared (15s)	$+220^\circ\text{C}$

Stresses beyond those listed under "Absolute Maximum Ratings" may cause permanent damage to the device. These are stress ratings only, and functional operation of the device at these or any other conditions beyond those indicated in the operational sections of the specifications is not implied. Exposure to absolute maximum rating conditions for extended periods may affect device reliability.

ELECTRICAL CHARACTERISTICS

($V_{DD} = +3.0\text{V}$ to $+5.5\text{V}$, $C_S = 2200\text{pF}$, $T_A = -40^\circ\text{C}$ to $+85^\circ\text{C}$, $T_{\text{REMOTE}} = +45^\circ\text{C}$ to $+125^\circ\text{C}$ (Note 1), unless otherwise noted. Typical values are at $T_A = +25^\circ\text{C}$.) (Note 2)

PARAMETER	SYMBOL	CONDITIONS	MIN	TYP	MAX	UNITS
Supply Voltage Range	V_{DD}		3.0		5.5	V
Supply Current	I_{DD}			400	600	μA
Temperature Threshold Accuracy (Note 3)	ΔT_{TH}	$T_A = -5^\circ\text{C}$ to $+55^\circ\text{C}$	-3.0		+3.0	$^\circ\text{C}$
		$T_A = -40^\circ\text{C}$ to $+85^\circ\text{C}$	-5.0		+5.0	
Power-Supply Sensitivity for Temperature Trip Point				-0.6		$^\circ\text{C}/\text{V}$
Temperature Threshold Hysteresis	T_{HYST}	HYST = V_{IL}		5		$^\circ\text{C}$
		HYST = V_{IH}		10		
Response Time				70	120	ms
Input Voltage High	V_{IH}		$V_{DD} - 0.2$			V
Input Voltage Low	V_{IL}				0.2	V
Output Voltage High	V_{OH}	MAX6511/MAX6513, $I_{\text{OUT}} = 1\text{mA}$	$V_{DD} - 0.2$			V
Output Voltage Low	V_{OL}	$I_{\text{OUT}} = 1\text{mA}$			0.2	V
Maximum DXP Source Current		$0.4\text{V} \leq V_{\text{DXP}} \leq 2\text{V}$, DXN = GND		270		μA
Minimum DXP Source Current		$0.4\text{V} \leq V_{\text{DXP}} \leq 2\text{V}$, DXN = GND		9		μA

Note 1: T_{REMOTE} refers to the temperature of the remote-sensing junction. T_A refers to the temperature of the MAX6511/MAX6512/MAX6513 package.

Note 2: All parameters are 100% production tested at $T_A = +25^\circ\text{C}$. Specifications over temperature limits are guaranteed by design.

Note 3: This parameter is guaranteed by design to ± 3.5 sigma.

Low-Cost, Remote SOT Temperature Switches

Typical Operating Characteristics

($V_{DD} = +3.3V$, $C_S = 2200pF$, $T_A = +25^\circ C$, unless otherwise noted.)

MAX6511/MAX6512/MAX6513

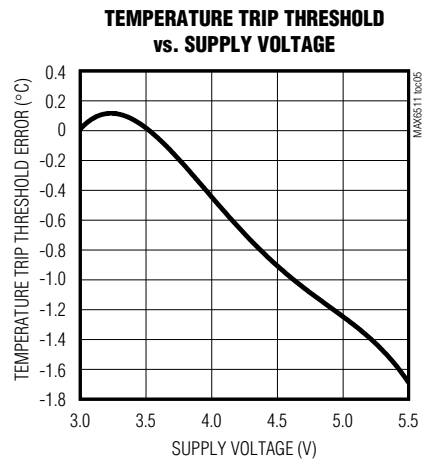
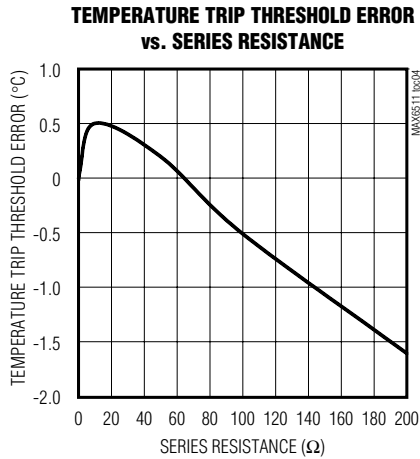
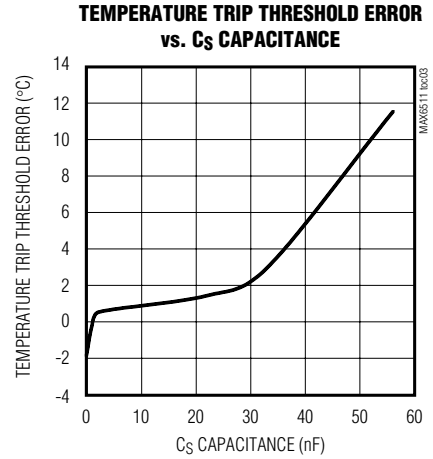
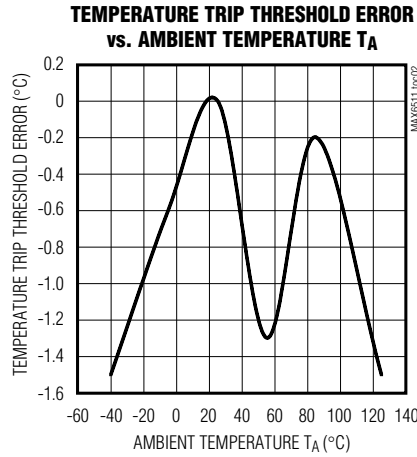
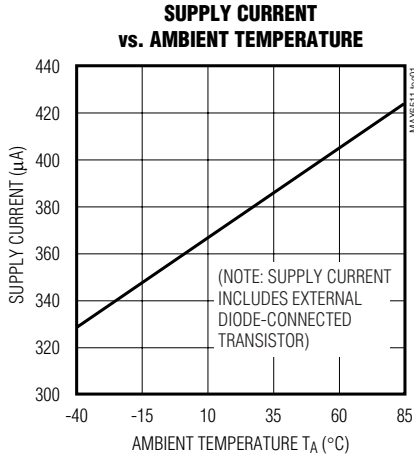

Low-Cost, Remote SOT Temperature Switches

Pin Description

PIN		NAME	FUNCTION
MAX6511 MAX6512	MAX6513		
1	1	V _{DD}	Power-Supply Input, +3.0V to +5.5V. Bypass V _{DD} to GND with a 0.1μF capacitor.
2	2	GND	Ground
3	3	HYST	Hysteresis Selection. Hysteresis is 10°C for HYST = V _{DD} , 5°C for HYST = GND.
4	—	$\overline{\text{TOVER}}$	CMOS Active-Low Output (MAX6511) or Open-Drain Active-Low Output (MAX6512). $\overline{\text{TOVER}}$ goes low when the temperature exceeds the factory-programmed temperature threshold. This pin can only sink current in the MAX6512.
—	4	TOVER	CMOS Active-High Output (MAX6513). TOVER goes high when the temperature exceeds the factory-programmed temperature threshold.
5	5	DXN	This pin connects to the negative (cathode) terminal of the external P-N sense junction. DXN must be connected to GND.
6	6	DXP	This pin connects to the positive (anode) terminal of the external P-N sense junction.

Detailed Description

The MAX6511/MAX6512/MAX6513 fully integrated temperature switches incorporate a precision bandgap reference, a conversion block, a current source, and a comparator (Figure 1). These devices use an external P-N junction as the temperature-sensing element. They steer bias currents through the external diode, measure the forward voltages, and compute the temperature using a precision chopper stabilized amplifier.

Resistance values of less than 100Ω in series with the external sense junction will result in trip-point errors <1°C. The MAX6511/MAX6512/MAX6513 provide noise immunity by integration and oversampling of the diode voltage, but good design practice includes routing the DXP and DXN lines away from noise sources, such as high-speed digital lines, switching regulators, inductors, and transformers. The DXP and DXN traces should be paired together and surrounded by ground plane whenever possible.

In applications where the temperature changes rapidly, the measured temperature will be approximately equal to the average value of the temperature during the measurement period.

The MAX6512 has an active-low, open-drain output structure that can only sink current. The MAX6511 has an active-low CMOS output structure, and the MAX6513 has an active-high CMOS output.

The MAX6511/MAX6512/MAX6513 are available with preset temperature thresholds from +45°C to +125°C in 10°C increments.

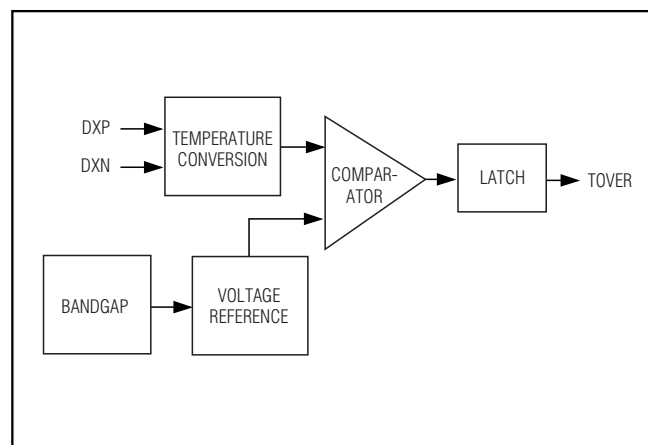

Figure 1. Functional Block Diagram

Low-Cost, Remote SOT Temperature Switches

MAX6511/MAX6512/MAX6513

Table 1. Sensor Transistor Manufacturers

MANUFACTURER	MODEL NUMBER
Central Semiconductor (USA)	CMPT3904
ON (USA)	MMBT3904
Rohm Semiconductor (Japan)	SST3904
Samsung (Korea)	KST3904-TF
Siemens (Germany)	SMBT3904
Zetex (England)	FMMT3904CT-ND

Note: Transistors must be diode connected (base shorted to collector).

Hysteresis Input

The HYST pin is a CMOS-compatible input that selects hysteresis at either a high level (10°C for HYST = V_{DD}) or a low level (5°C for HYST = GND). Hysteresis prevents the output from chattering when the temperature is near the trip point. The HYST pin must not float.

The output asserts when the temperature exceeds the trip point and deasserts when the temperature falls back below the trip point minus the hysteresis. For example, if the trip point is 105°C, the output will assert at 105°C and will not deassert until temperature falls below 105°C minus the hysteresis (e.g., 95°C if 10°C hysteresis is chosen) (Figure 2).

Applications Information

Remote-Diode Selection

To ensure best accuracy, use a good-quality diode-connected transistor. Suggested devices are listed in Table 1. Large power transistors are not recommended. Tight specifications for forward current gain indi-

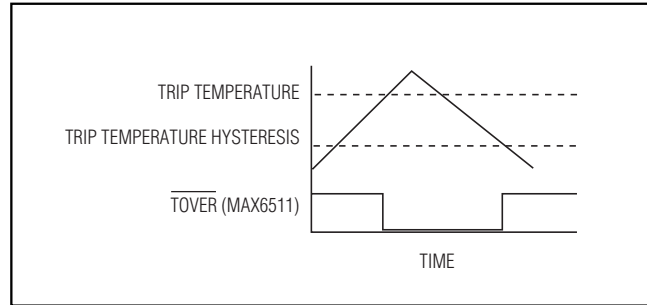

Figure 2. Temperature Trip Threshold Hysteresis

cate the manufacturer has good process controls and that the devices have consistent V_{be} characteristics. The MAX6511/MAX6512/MAX6513 can also measure the die temperature of CPUs and other integrated circuits having on-board temperature-sensing diodes. Use the monitor's output to reset the μP, assert an interrupt, activate a cooling fan, or trigger an external alarm.

Noise Filtering Capacitors

A quality ceramic capacitor must be connected across the DXP/DXN inputs to maintain temperature threshold accuracy by filtering out noise. The capacitor should be located physically close to the DXP/DXN pins and should typically have a value of 2200pF. Larger capacitor values can cause temperature measurement errors. A 50% variation from the recommended capacitor value can cause up to ±1°C error.

Low-Cost, Remote SOT Temperature Switches

MAX6511/MAX6512/MAX6513

Typical Operating Circuit

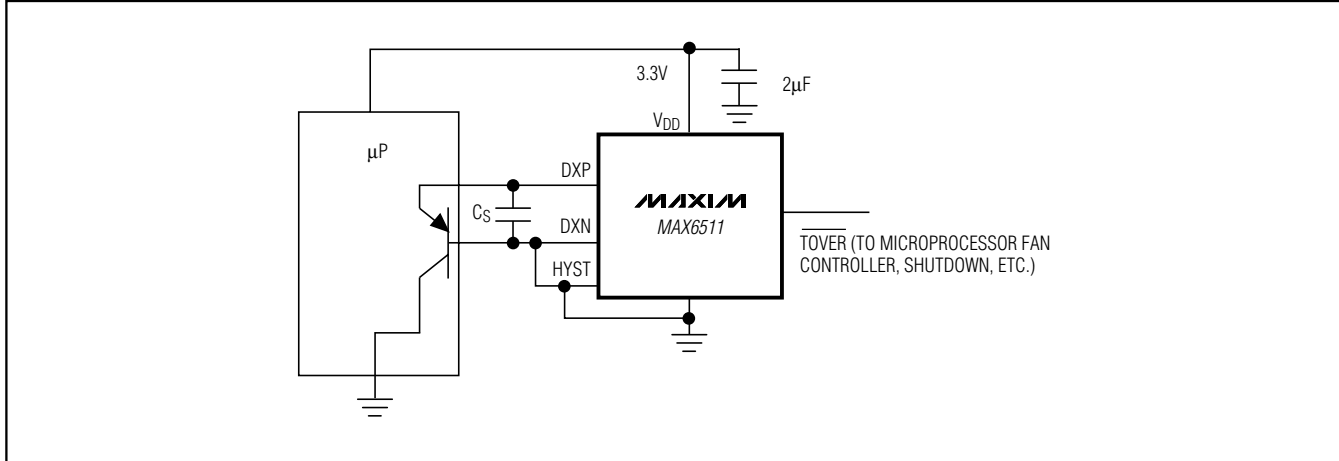

Device Marking Codes for SOT23-6 Package

DEVICE	CODE	TEMPERATURE TRIP THRESHOLD (°C)
MAX6511UT045	AAOA	45
MAX6511UT055	AAOB	55
MAX6511UT065	AAOC	65
MAX6511UT075	AAOD	75
MAX6511UT085	AAOE	85
MAX6511UT095	AAOF	95
MAX6511UT105	AAOG	105
MAX6511UT115	AAOH	115
MAX6511UT125	AAOI	125
MAX6512UT045	AAOJ	45
MAX6512UT055	AAOK	55
MAX6512UT065	AAOL	65
MAX6512UT075	AAOM	75
MAX6512UT085	AAON	85
MAX6512UT095	AAOO	95
MAX6512UT105	AAOP	105
MAX6512UT115	AAOQ	115
MAX6512UT125	AAOR	125

DEVICE	CODE	TEMPERATURE TRIP THRESHOLD (°C)
MAX6513UT045	AAPD	45
MAX6513UT055	AAPE	55
MAX6513UT065	AAPF	65
MAX6513UT075	AAPG	75
MAX6513UT085	AAPH	85
MAX6513UT095	AAPI	95
MAX6513UT105	AAPJ	105
MAX6513UT115	AAPK	115
MAX6513UT125	AAPL	125
MAX6513TT045	+ACU	45
MAX6513TT055	+ACV	55
MAX6513TT065	+ACW	65
MAX6513TT075	+ACX	75
MAX6513TT085	+ACY	85
MAX6513TT095	+ACZ	95
MAX6513TT105	+ADA	105
MAX6513TT115	+ADB	115
MAX6513TT125	+ADC	125

Chip Information

TRANSISTOR COUNT: 3300

Low-Cost, Remote SOT Temperature Switches

Package Information

(The package drawing(s) in this data sheet may not reflect the most current specifications. For the latest package outline information go to www.maxim-ic.com/packages.)

MAX6511/MAX6512/MAX6513

SYMBOL	MIN	MAX
A	0.90	1.45
A1	0.00	0.15
A2	0.90	1.30
b	0.35	0.50
C	0.08	0.20
D	2.80	3.00
E	2.60	3.00
E1	1.50	1.75
L	0.35	0.60
L1	0.60	REF.
e1	1.90	BSC.
e	0.95	BSC.
a	0°	10°

NOTES:

- ALL DIMENSIONS ARE IN MILLIMETERS.
- FOOT LENGTH MEASURED AT INTERCEPT POINT BETWEEN DATUM A & LEAD SURFACE.
- PACKAGE OUTLINE EXCLUSIVE OF MOLD FLASH & METAL BURR. MOLD FLASH, PROTRUSION OR METAL BURR SHOULD NOT EXCEED 0.25 MM.
- PACKAGE OUTLINE INCLUSIVE OF SOLDER PLATING.
- PIN 1 IS LOWER LEFT PIN WHEN READING TOP MARK FROM LEFT TO RIGHT. (SEE EXAMPLE TOP MARK)
- PIN 1 I.D. DOT IS 0.3 MM Ø MIN. LOCATED ABOVE PIN 1.
- MEETS JEDEC MO178, VARIATION AB.
- SOLDER THICKNESS MEASURED AT FLAT SECTION OF LEAD BETWEEN 0.08mm AND 0.15mm FROM LEAD TIP.
- LEAD TO BE COPLANAR WITHIN 0.1 MM.

6LSOT.EPS

DALLAS SEMICONDUCTOR **MAXIM**

PROPRIETARY INFORMATION

TITLE: PACKAGE OUTLINE, SOT-23, 6L

APPROVAL	DOCUMENT CONTROL NO. 21-0058	REV. F	1/1
----------	---------------------------------	-----------	-----

Low-Cost, Remote SOT Temperature Switches

Package Information (continued)

(The package drawing(s) in this data sheet may not reflect the most current specifications. For the latest package outline information go to www.maxim-ic.com/packages.)

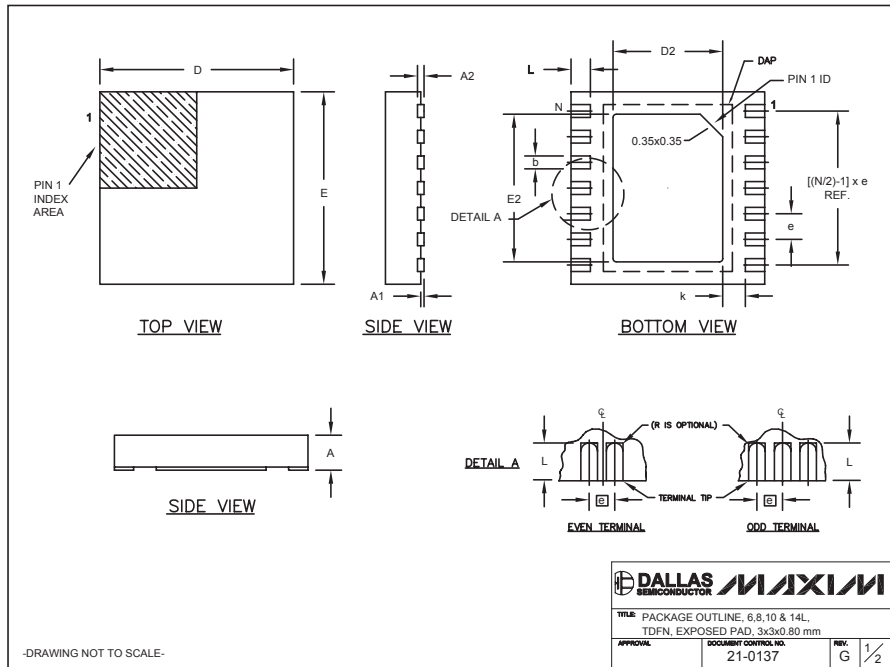

COMMON DIMENSIONS		
SYMBOL	MIN.	MAX.
A	0.70	0.80
D	2.90	3.10
E	2.90	3.10
A1	0.00	0.05
L	0.20	0.40
k	0.25 MIN.	
A2	0.20 REF.	

PACKAGE VARIATIONS								
PKG. CODE	N	D2	E2	e	JEDEC SPEC	b	[(N/2)-1] x e	DOWNBONDS ALLOWED
T633-1	6	1.50±0.10	2.30±0.10	0.95 BSC	MO229 / WEEA	0.40±0.05	1.90 REF	NO
T633-2	6	1.50±0.10	2.30±0.10	0.95 BSC	MO229 / WEEA	0.40±0.05	1.90 REF	NO
T833-1	8	1.50±0.10	2.30±0.10	0.65 BSC	MO229 / WEEC	0.30±0.05	1.95 REF	NO
T833-2	8	1.50±0.10	2.30±0.10	0.65 BSC	MO229 / WEEC	0.30±0.05	1.95 REF	NO
T833-3	8	1.50±0.10	2.30±0.10	0.65 BSC	MO229 / WEEC	0.30±0.05	1.95 REF	YES
T1033-1	10	1.50±0.10	2.30±0.10	0.50 BSC	MO229 / WEED-3	0.25±0.05	2.00 REF	NO
T1433-1	14	1.70±0.10	2.30±0.10	0.40 BSC	----	0.20±0.05	2.40 REF	YES
T1433-2	14	1.70±0.10	2.30±0.10	0.40 BSC	----	0.20±0.05	2.40 REF	NO

- NOTES:
- ALL DIMENSIONS ARE IN mm. ANGLES IN DEGREES.
 - COPLANARITY SHALL NOT EXCEED 0.08 mm.
 - WARPAGE SHALL NOT EXCEED 0.10 mm.
 - PACKAGE LENGTH/PACKAGE WIDTH ARE CONSIDERED AS SPECIAL CHARACTERISTIC(S).
 - DRAWING CONFORMS TO JEDEC MO229, EXCEPT DIMENSIONS "D2" AND "E2", AND T1433-1 & T1433-2.
 - "N" IS THE TOTAL NUMBER OF LEADS.
 - NUMBER OF LEADS SHOWN ARE FOR REFERENCE ONLY.

-DRAWING NOT TO SCALE-

APPROVAL	DOCUMENT CONTROL NO.	REV.
	21-0137	G 2/2

Maxim cannot assume responsibility for use of any circuitry other than circuitry entirely embodied in a Maxim product. No circuit patent licenses are implied. Maxim reserves the right to change the circuitry and specifications without notice at any time.

8 **Maxim Integrated Products, 120 San Gabriel Drive, Sunnyvale, CA 94086 408-737-7600**

SITE
SEARCHPART NO.
SEARCH

WHAT'S NEW

PRODUCTS

SOLUTIONS

DESIGN

APPNOTES

SUPPORT

BUY

COMPANY

MEMBERS

[Maxim](#) > [Products](#) > [Temperature Sensors](#)

MAX6511, MAX6512, MAX6513

Low-Cost, Remote SOT Temperature Switches

Industry's Only Temperature Switch for External P-N Junction - Either a Discrete Diode-Connected Transistor on an External IC Die[QuickView](#)[Technical Documents](#)[Ordering Info](#)[More Information](#)[All](#)

Ordering Information

Notes:

1. Other options and links for purchasing parts are listed at: <http://www.maxim-ic.com/sales>.
2. [Didn't Find What You Need?](#) Ask our applications engineers. Expert assistance in finding parts, usually within one business day.
3. Part number suffixes: T or T&R = tape and reel; + = RoHS/lead-free; # = RoHS/lead-exempt. More: See [Full Data Sheet](#) or [Part Naming Conventions](#).
4. * Some packages have variations, listed on the drawing. "PkgCode/Variation" tells which variation the product uses.

Devices: 1-60 of 60

MAX6511	Free Sample	Buy	Package: TYPE PINS FOOTPRINT DRAWING CODE/VAR *	Temp	RoHS/Lead-Free? Materials Analysis
MAX6511UT115			SOT-23;6 pin;9 mm Dwg: 21-0058I (PDF) Use pkgcode/variation: U6F-6*	-40C to +85C	RoHS/Lead-Free: No Materials Analysis
MAX6511UT045			SOT-23;6 pin;9 mm Dwg: 21-0058I (PDF) Use pkgcode/variation: U6F-6*	-40C to +85C	RoHS/Lead-Free: See data sheet Materials Analysis
MAX6511UT055			SOT-23;6 pin;9 mm Dwg: 21-0058I (PDF) Use pkgcode/variation: U6F-6*	-40C to +85C	RoHS/Lead-Free: See data sheet Materials Analysis
MAX6511UT065			SOT-23;6 pin;9 mm Dwg: 21-0058I (PDF) Use pkgcode/variation: U6F-6*	-40C to +85C	RoHS/Lead-Free: See data sheet Materials Analysis
MAX6511UT075			SOT-23;6 pin;9 mm Dwg: 21-0058I (PDF) Use pkgcode/variation: U6F-6*	-40C to +85C	RoHS/Lead-Free: See data sheet Materials Analysis
MAX6511UT085			SOT-23;6 pin;9 mm Dwg: 21-0058I (PDF) Use pkgcode/variation: U6F-6*	-40C to +85C	RoHS/Lead-Free: No Materials Analysis
MAX6511UT095			SOT-23;6 pin;9 mm Dwg: 21-0058I (PDF) Use pkgcode/variation: U6F-6*	-40C to +85C	RoHS/Lead-Free: No Materials Analysis
MAX6511UT105			SOT-23;6 pin;9 mm Dwg: 21-0058I (PDF) Use pkgcode/variation: U6F-6*	-40C to +85C	RoHS/Lead-Free: See data sheet Materials Analysis
MAX6511UT125			SOT-23;6 pin;9 mm Dwg: 21-0058I (PDF) Use pkgcode/variation: U6F-6*	-40C to +85C	RoHS/Lead-Free: No Materials Analysis
MAX6511UT115-T			SOT-23;6 pin;9 mm Dwg: 21-0058I (PDF) Use pkgcode/variation: U6F-6*	-40C to +85C	RoHS/Lead-Free: No Materials Analysis
MAX6511UT125-T			SOT-23;6 pin;9 mm Dwg: 21-0058I (PDF) Use pkgcode/variation: U6F-6*	-40C to +85C	RoHS/Lead-Free: No Materials Analysis
MAX6511UT105-T			SOT-23;6 pin;9 mm Dwg: 21-0058I (PDF) Use pkgcode/variation: U6F-6*	-40C to +85C	RoHS/Lead-Free: See data sheet Materials Analysis

MAX6511UT095-T			SOT-23;6 pin;9 mm Dwg: 21-0058I (PDF) Use pkgcode/variation: U6F-6*	-40C to +85C	RoHS/Lead-Free: No Materials Analysis
MAX6511UT085-T			SOT-23;6 pin;9 mm Dwg: 21-0058I (PDF) Use pkgcode/variation: U6F-6*	-40C to +85C	RoHS/Lead-Free: No Materials Analysis
MAX6511UT075-T			SOT-23;6 pin;9 mm Dwg: 21-0058I (PDF) Use pkgcode/variation: U6F-6*	-40C to +85C	RoHS/Lead-Free: See data sheet Materials Analysis
MAX6511UT065-T			SOT-23;6 pin;9 mm Dwg: 21-0058I (PDF) Use pkgcode/variation: U6F-6*	-40C to +85C	RoHS/Lead-Free: See data sheet Materials Analysis
MAX6511UT055-T			SOT-23;6 pin;9 mm Dwg: 21-0058I (PDF) Use pkgcode/variation: U6F-6*	-40C to +85C	RoHS/Lead-Free: See data sheet Materials Analysis
MAX6511UT045-T			SOT-23;6 pin;9 mm Dwg: 21-0058I (PDF) Use pkgcode/variation: U6F-6*	-40C to +85C	RoHS/Lead-Free: See data sheet Materials Analysis
MAX6512	Free Sample	Buy	Package: TYPE PINS FOOTPRINT DRAWING CODE/VAR *	Temp	RoHS/Lead-Free? Materials Analysis
MAX6512UT045			SOT-23;6 pin;9 mm Dwg: 21-0058I (PDF) Use pkgcode/variation: U6F-6*	-40C to +85C	RoHS/Lead-Free: No Materials Analysis
MAX6512UT055			SOT-23;6 pin;9 mm Dwg: 21-0058I (PDF) Use pkgcode/variation: U6F-6*	-40C to +85C	RoHS/Lead-Free: No Materials Analysis
MAX6512UT065			SOT-23;6 pin;9 mm Dwg: 21-0058I (PDF) Use pkgcode/variation: U6F-6*	-40C to +85C	RoHS/Lead-Free: See data sheet Materials Analysis
MAX6512UT075			SOT-23;6 pin;9 mm Dwg: 21-0058I (PDF) Use pkgcode/variation: U6F-6*	-40C to +85C	RoHS/Lead-Free: See data sheet Materials Analysis
MAX6512UT085			SOT-23;6 pin;9 mm Dwg: 21-0058I (PDF) Use pkgcode/variation: U6F-6*	-40C to +85C	RoHS/Lead-Free: No Materials Analysis
MAX6512UT095			SOT-23;6 pin;9 mm Dwg: 21-0058I (PDF) Use pkgcode/variation: U6F-6*	-40C to +85C	RoHS/Lead-Free: No Materials Analysis
MAX6512UT105			SOT-23;6 pin;9 mm Dwg: 21-0058I (PDF) Use pkgcode/variation: U6F-6*	-40C to +85C	RoHS/Lead-Free: No Materials Analysis
MAX6512UT115			SOT-23;6 pin;9 mm Dwg: 21-0058I (PDF) Use pkgcode/variation: U6F-6*	-40C to +85C	RoHS/Lead-Free: No Materials Analysis
MAX6512UT125			SOT-23;6 pin;9 mm Dwg: 21-0058I (PDF) Use pkgcode/variation: U6F-6*	-40C to +85C	RoHS/Lead-Free: No Materials Analysis
MAX6512UT115-T			SOT-23;6 pin;9 mm Dwg: 21-0058I (PDF) Use pkgcode/variation: U6F-6*	-40C to +85C	RoHS/Lead-Free: No Materials Analysis
MAX6512UT075-T			SOT-23;6 pin;9 mm Dwg: 21-0058I (PDF) Use pkgcode/variation: U6F-6*	-40C to +85C	RoHS/Lead-Free: See data sheet Materials Analysis
MAX6512UT055-T			SOT-23;6 pin;9 mm Dwg: 21-0058I (PDF) Use pkgcode/variation: U6F-6*	-40C to +85C	RoHS/Lead-Free: No Materials Analysis
MAX6512UT065-T			SOT-23;6 pin;9 mm Dwg: 21-0058I (PDF) Use pkgcode/variation: U6F-6*	-40C to +85C	RoHS/Lead-Free: See data sheet Materials Analysis
MAX6512UT085-T			SOT-23;6 pin;9 mm Dwg: 21-0058I (PDF) Use pkgcode/variation: U6F-6*	-40C to +85C	RoHS/Lead-Free: No Materials Analysis
MAX6512UT095-T			SOT-23;6 pin;9 mm Dwg: 21-0058I (PDF) Use pkgcode/variation: U6F-6*	-40C to +85C	RoHS/Lead-Free: No Materials Analysis
MAX6512UT105-T			SOT-23;6 pin;9 mm Dwg: 21-0058I (PDF) Use pkgcode/variation: U6F-6*	-40C to +85C	RoHS/Lead-Free: No Materials Analysis

MAX6512UT125-T			SOT-23;6 pin;9 mm Dwg: 21-0058I (PDF) Use pkgcode/variation: U6F-6*	-40C to +85C	RoHS/Lead-Free: No Materials Analysis
MAX6512UT045-T			SOT-23;6 pin;9 mm Dwg: 21-0058I (PDF) Use pkgcode/variation: U6F-6*	-40C to +85C	RoHS/Lead-Free: No Materials Analysis
MAX6513	Free Sample	Buy	Package: TYPE PINS FOOTPRINT DRAWING CODE/VAR *	Temp	RoHS/Lead-Free? Materials Analysis
MAX6513UT105			SOT-23;6 pin;9 mm Dwg: 21-0058I (PDF) Use pkgcode/variation: U6F-6*	-40C to +85C	RoHS/Lead-Free: See data sheet Materials Analysis
MAX6513UT085			SOT-23;6 pin;9 mm Dwg: 21-0058I (PDF) Use pkgcode/variation: U6F-6*	-40C to +85C	RoHS/Lead-Free: No Materials Analysis
MAX6513UT115			SOT-23;6 pin;9 mm Dwg: 21-0058I (PDF) Use pkgcode/variation: U6F-6*	-40C to +85C	RoHS/Lead-Free: See data sheet Materials Analysis
MAX6513UT045			SOT-23;6 pin;9 mm Dwg: 21-0058I (PDF) Use pkgcode/variation: U6F-6*	-40C to +85C	RoHS/Lead-Free: See data sheet Materials Analysis
MAX6513UT055			SOT-23;6 pin;9 mm Dwg: 21-0058I (PDF) Use pkgcode/variation: U6F-6*	-40C to +85C	RoHS/Lead-Free: No Materials Analysis
MAX6513UT065			SOT-23;6 pin;9 mm Dwg: 21-0058I (PDF) Use pkgcode/variation: U6F-6*	-40C to +85C	RoHS/Lead-Free: See data sheet Materials Analysis
MAX6513UT075			SOT-23;6 pin;9 mm Dwg: 21-0058I (PDF) Use pkgcode/variation: U6F-6*	-40C to +85C	RoHS/Lead-Free: See data sheet Materials Analysis
MAX6513UT095			SOT-23;6 pin;9 mm Dwg: 21-0058I (PDF) Use pkgcode/variation: U6F-6*	-40C to +85C	RoHS/Lead-Free: See data sheet Materials Analysis
MAX6513UT125			SOT-23;6 pin;9 mm Dwg: 21-0058I (PDF) Use pkgcode/variation: U6F-6*	-40C to +85C	RoHS/Lead-Free: See data sheet Materials Analysis
MAX6513UT125-T			SOT-23;6 pin;9 mm Dwg: 21-0058I (PDF) Use pkgcode/variation: U6F-6*	-40C to +85C	RoHS/Lead-Free: See data sheet Materials Analysis
MAX6513UT075-T			SOT-23;6 pin;9 mm Dwg: 21-0058I (PDF) Use pkgcode/variation: U6F-6*	-40C to +85C	RoHS/Lead-Free: See data sheet Materials Analysis
MAX6513UT065-T			SOT-23;6 pin;9 mm Dwg: 21-0058I (PDF) Use pkgcode/variation: U6F-6*	-40C to +85C	RoHS/Lead-Free: See data sheet Materials Analysis
MAX6513UT095-T			SOT-23;6 pin;9 mm Dwg: 21-0058I (PDF) Use pkgcode/variation: U6F-6*	-40C to +85C	RoHS/Lead-Free: See data sheet Materials Analysis
MAX6513UT055-T			SOT-23;6 pin;9 mm Dwg: 21-0058I (PDF) Use pkgcode/variation: U6F-6*	-40C to +85C	RoHS/Lead-Free: No Materials Analysis
MAX6513UT045-T			SOT-23;6 pin;9 mm Dwg: 21-0058I (PDF) Use pkgcode/variation: U6F-6*	-40C to +85C	RoHS/Lead-Free: See data sheet Materials Analysis
MAX6513UT085-T			SOT-23;6 pin;9 mm Dwg: 21-0058I (PDF) Use pkgcode/variation: U6F-6*	-40C to +85C	RoHS/Lead-Free: No Materials Analysis
MAX6513UT105-T			SOT-23;6 pin;9 mm Dwg: 21-0058I (PDF) Use pkgcode/variation: U6F-6*	-40C to +85C	RoHS/Lead-Free: See data sheet Materials Analysis
MAX6513UT115-T			SOT-23;6 pin;9 mm Dwg: 21-0058I (PDF) Use pkgcode/variation: U6F-6*	-40C to +85C	RoHS/Lead-Free: See data sheet Materials Analysis
MAX6513TT045+T			THIN QFN (Dual);6 pin;10 mm Dwg: 21-0137I (PDF) Use pkgcode/variation: T633+2*	-40C to +85C	RoHS/Lead-Free: Lead Free Materials Analysis
MAX6513TT045+			THIN QFN (Dual);6 pin;10 mm Dwg: 21-0137I (PDF) Use pkgcode/variation: T633+2*	-40C to +85C	RoHS/Lead-Free: Lead Free Materials Analysis

MAX6513TT075			THIN QFN (Dual);6 pin;10 mm Dwg: 21-0137I (PDF) Use pkgcode/variation: T633-2*	-40C to +85C	RoHS/Lead-Free: No Materials Analysis
MAX6513TT075+			THIN QFN (Dual);6 pin;10 mm Dwg: 21-0137I (PDF) Use pkgcode/variation: T633+2*	-40C to +85C	RoHS/Lead-Free: Lead Free Materials Analysis
MAX6513TT075-T			THIN QFN (Dual);6 pin;10 mm Dwg: 21-0137I (PDF) Use pkgcode/variation: T633-2*	-40C to +85C	RoHS/Lead-Free: No Materials Analysis
MAX6513TT075+T			THIN QFN (Dual);6 pin;10 mm Dwg: 21-0137I (PDF) Use pkgcode/variation: T633+2*	-40C to +85C	RoHS/Lead-Free: Lead Free Materials Analysis

Didn't Find What You Need?

- [Next Day Product Selection Assistance from Applications Engineers](#)
- [Parametric Search](#)
- [Applications Help](#)

QuickView

[Description](#)
[Key Features](#)
[Applications/Uses](#)
[Key Specifications](#)
[Diagram](#)

Technical Documents

[Data Sheet](#)
[Application Notes](#)
[Design Guides](#)
[Engineering Journals](#)
[Reliability Reports](#)
[Software/Models](#)
[Evaluation Kits](#)

Ordering Info

[Price and Availability](#)
[Samples](#)
[Buy Online](#)
[Package Information](#)
[Lead-Free Information](#)

More Information

[Related Products](#)
[Notes and Comments](#)
[Evaluation Kits](#)

Document Ref.: 19-1819; Rev 2; 2004-11-19
This page last modified: 2007-07-24

[CONTACT US: SEND US AN EMAIL](#)