



MAXIM

3.3V/5V or Adjustable-Output, Single-Cell DC-DC Converters

General Description

The MAX866 and MAX867 are ultra-small, high-efficiency, CMOS, step-up, DC-DC switching regulators for 1-cell battery-powered systems. The MAX866 accepts a positive input voltage between 0.8V and V_{OUT} and converts it to a higher, pin-selectable output voltage of 3.3V or 5V. The MAX867 adjustable version accepts 0.8V to 6.0V input voltages and generates a higher adjustable output voltage in the 2.7V to 6.0V range. Typical efficiencies are greater than 80%. Typical no-load supply current is 100 μ A (1 μ A in shutdown).

The MAX866/MAX867 combine ultra-low quiescent supply current and high efficiency to give maximum battery life. Its high switching frequency permits the use of small, low-cost inductors and capacitors. Additionally, internal peak-current limiting protects the IC.

Applications

Pagers
Remote Controls
Detectors
1-Cell Battery-Operated Equipment
Backup Supplies

Typical Operating Circuit

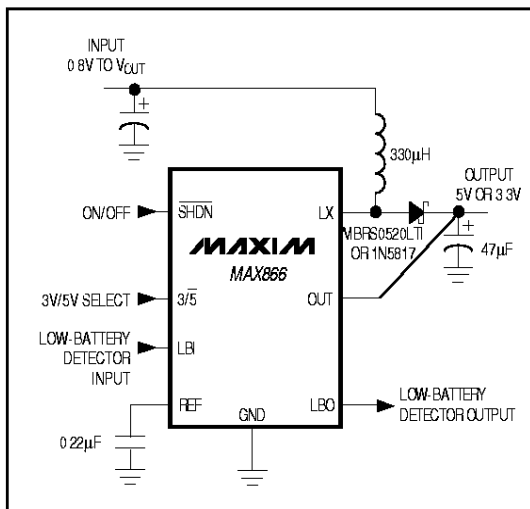

Features

- ◆ 0.8V to 6.0V Input Supply Voltage
- ◆ 0.9V Guaranteed Start-Up Supply Voltage
- ◆ >80% Efficiency Over Wide Load Range
- ◆ 100 μ A No-Load Battery Current ($V_{OUT} = 3.3V$)
- ◆ 1 μ A Shutdown Mode
- ◆ Up to 250kHz Switching Frequency
- ◆ $\pm 1.5\%$ Reference Tolerance
- ◆ Low-Battery Detector (LBI/LBO)
- ◆ Available In Ultra-Small 8-Pin μ MAX Package (1.11mm high)
- ◆ Circuit Fits In 0.2In²

Ordering Information

PART	TEMP. RANGE	PIN-PACKAGE
MAX866C/D	0°C to +70°C	Dice*
MAX866ESA	-40°C to +85°C	8 SO
MAX866EUA	-40°C to +85°C	8 μ MAX
MAX867C/D	0°C to +70°C	Dice*
MAX867ESA	-40°C to +85°C	8 SO
MAX867EUA	-40°C to +85°C	8 μ MAX

* Dice are tested at $T_A = +25^\circ\text{C}$ only.

Pin Configurations

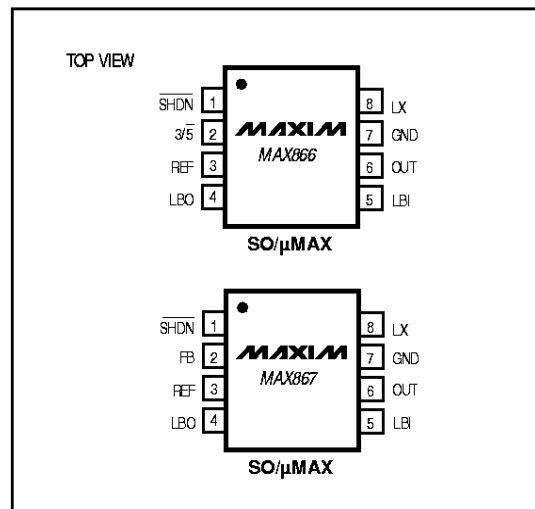

MAXIM

Maxim Integrated Products 1

For free samples & the latest literature: <http://www.maxim-ic.com>, or phone 1-800-998-8800

MAX866/MAX867

3.3V/5V or Adjustable-Output, Single-Cell DC-DC Converters

ABSOLUTE MAXIMUM RATINGS

Supply Voltage (OUT to GND)	-0.3V, +7V	Reverse Battery Current ($T_A \leq +45^\circ\text{C}$) (Note 1)	750mA
Switch Voltage (LX to GND)	-0.3V, +7V	Operating Temperature Ranges	
SHDN, LBO to GND	-0.3V, +7V	MAX86_C/D	0°C to +70°C
LBI, REF, 3/5, FB to GND	-0.3V, (V _{OUT} + 0.3V)	MAX86_E_A	-40°C to +85°C
Reference Current (I _{REF})	2.5mA	Junction Temperature	+150°C
Continuous Power Dissipation ($T_A = +70^\circ\text{C}$)		Storage Temperature Range	-65°C to +160°C
SO (derate 5.88mW/°C above +70°C)	471mW	Lead Temperature (soldering, 10sec)	+300°C
μMAX (derate 4.1mW/°C above +70°C)	330mW		

Note 1: Reverse battery current is measured from the *Typical Operating Circuit's* battery input terminal to GND when the battery is connected backwards. A reverse current of 750mA will not exceed the package dissipation limits but, if left for an extended time (more than ten minutes), may degrade performance.

Stresses beyond those listed under "Absolute Maximum Ratings" may cause permanent damage to the device. These are stress ratings only, and functional operation of the device at these or any other conditions beyond those indicated in the operational sections of the specifications is not implied. Exposure to absolute maximum rating conditions for extended periods may affect device reliability.

ELECTRICAL CHARACTERISTICS

(Circuit of Figure 2, V_{IN} = 1.2V, I_{LOAD} = 0mA, T_A = +25°C, unless otherwise noted.)

PARAMETER	CONDITIONS		MIN	TYP	MAX	UNITS
Minimum Start-Up Supply Voltage				0.8	0.9	V
Output Voltage (Note 2)	0.9V ≤ V _{IN} ≤ 3V	MAX866, 3/5 = 0V, 0mA ≤ I _{LOAD} ≤ 6mA	4.80	5.0	5.20	V
		MAX866, 3/5 = 3V, 0mA ≤ I _{LOAD} ≤ 8mA	3.17	3.3	3.43	
		MAX867, V _{OUT} = 5V, 0mA ≤ I _{LOAD} ≤ 6mA	4.80	5.0	5.20	
	0.9V ≤ V _{IN} ≤ 3V, T _A = T _{MIN} TO T _{MAX} (Note 3)	MAX866, 3/5 = 0V, 0mA ≤ I _{LOAD} ≤ 6mA	4.75	5.0	5.25	
		MAX866, 3/5 = 3V, 0mA ≤ I _{LOAD} ≤ 8mA	3.13	3.3	3.47	
		MAX867, V _{OUT} = 5V, 0mA ≤ I _{LOAD} ≤ 6mA	4.75	5.0	5.25	
	1.2V ≤ V _{IN} ≤ 3V	MAX866, 3/5 = 0V, 0mA ≤ I _{LOAD} ≤ 10mA	4.80	5.0	5.20	
		MAX866, 3/5 = 3V, 0mA ≤ I _{LOAD} ≤ 15mA	3.17	3.3	3.43	
		MAX867, V _{OUT} = 5V, 0mA ≤ I _{LOAD} ≤ 10mA	4.80	5.0	5.20	
Maximum Load Current (Note 2)	0.9V ≤ V _{IN} ≤ 3V	MAX866, 3/5 = 0V, 4.8V ≤ V _{LOAD} ≤ 5.2V	6	9	mA	
		MAX866, 3/5 = 3V, 3.17V ≤ V _{LOAD} ≤ 3.43V	8	13		
		MAX867, V _{OUT} = 5V, 4.8V ≤ V _{LOAD} ≤ 5.2V	6	9		
	1.2V ≤ V _{IN} ≤ 3V	MAX866, 3/5 = 0V, 4.8V ≤ V _{LOAD} ≤ 5.2V	10	15		
		MAX866, 3/5 = 3V, 3.17V ≤ V _{LOAD} ≤ 3.43V	15	23		
		MAX867, V _{OUT} = 5V, 4.8V ≤ V _{LOAD} ≤ 5.2V	10	15		
Quiescent Supply Current in 3.3V mode (Note 4)	I _{LOAD} = 0mA, 3/5 = 3V, LBI = 1.5V, V _{OUT} = 3.47V, FB = 1.5V		27	60	μA	
No-Load Battery Current	Output set for 3.3V, measured at V _{IN} in Figure 2, V _{IN} = 1.5V		100		μA	
Shutdown Quiescent Current (Note 4)	SHDN = 0V, 3/5 = 3V, LBI = 1.5V, V _{OUT} = 3.47V, FB = 1.5V			1	μA	
Peak Inductor Current Limit			500		mA	
Reference Voltage	No REF load		1.22	1.25	1.28	V
Reference Load Regulation	3/5 = 3V, -20μA ≤ REF load ≤ 250μA, C _{REF} = 0.22μF		0.8	2.0		%
LBI Input Threshold	With falling edge		1.22	1.25	1.28	V

3.3V/5V or Adjustable-Output, Single-Cell DC-DC Converters

MAX866/MAX867

ELECTRICAL CHARACTERISTICS (continued)

(Circuit of Figure 2, $V_{IN} = 1.2V$, $I_{LOAD} = 0mA$, $T_A = +25^\circ C$, unless otherwise noted.)

PARAMETER	CONDITIONS	MIN	TYP	MAX	UNITS
LBI Input Hysteresis			25		mV
LBO Output Voltage Low	$I_{SINK} = 2mA$, open-drain output			0.4	V
LBO Output Leakage Current	LBO = 5V			1	μA
\overline{SHDN} , $\overline{3/5}$ Input Voltage Low				$0.08 \times V_{OUT}$	V
\overline{SHDN} , $\overline{3/5}$ Input Voltage High		$0.32 \times V_{OUT}$			V
\overline{SHDN} , $\overline{3/5}$, FB, LBI Input Current	LBI = 1.5V, FB = 1.5V, $\overline{SHDN} = 0V$ or 3V, $\overline{3/5} = 0V$ or 3V		± 40	± 100	nA
FB Voltage	MAX867, output in regulation	1.22	1.25	1.28	V
Output Voltage Range	MAX867	2.7		6.0	V

Note 2: Output current specified with circuit of Figure 2 and CoilCraft D01608-334 inductor for test purposes only. More (or less) output current can be supplied with other coil types depending on inductance value and coil resistance. See *Typical Operating Characteristics* for other coil types. Output voltage and output current are guaranteed over this V_{IN} operating range once the device has started up. Actual V_{IN} start-up voltage depends on load current.

Note 3: Output voltage specifications over temperature are guaranteed by design to limits that are 6 sigma from either side of the mean.

Note 4: Current measured into OUT. V_{OUT} is forced to 3.47V to maintain LX off when measuring device current.

Typical Operating Characteristics

(Circuits of Figure 2, $T_A = +25^\circ C$, unless otherwise noted.)

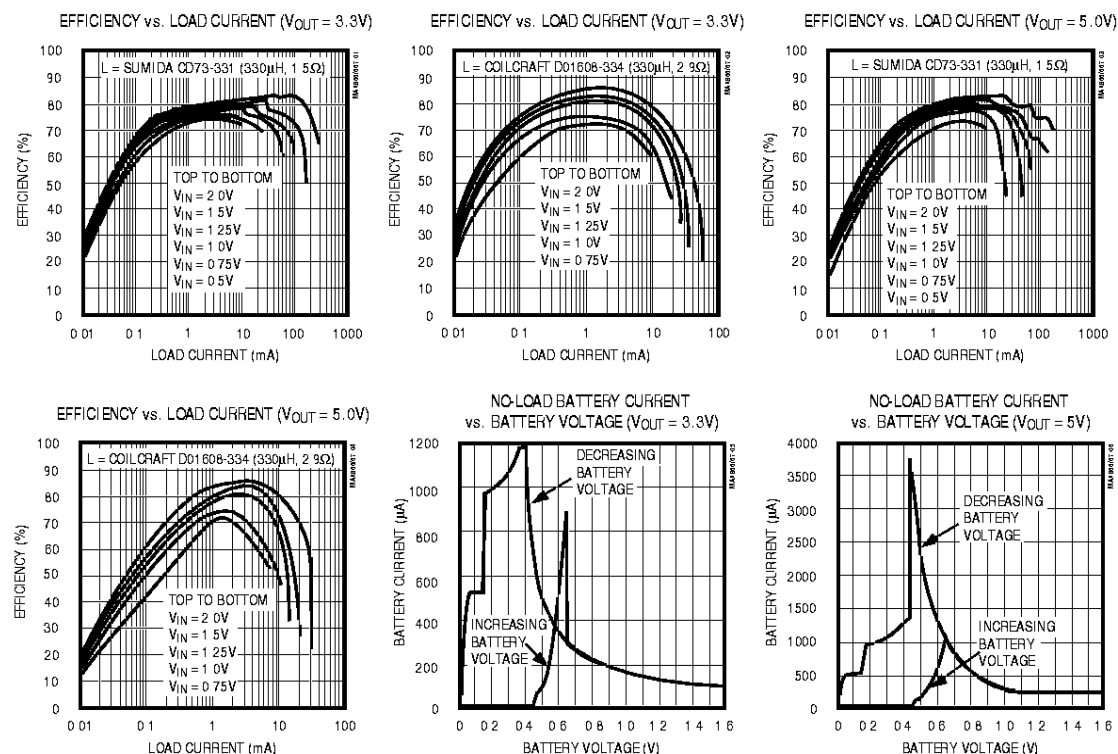

3.3V/5V or Adjustable-Output, Single-Cell DC-DC Converters

Typical Operating Characteristics (continued)

(Circuits of Figure 2, $T_A = +25^\circ\text{C}$, unless otherwise noted.)

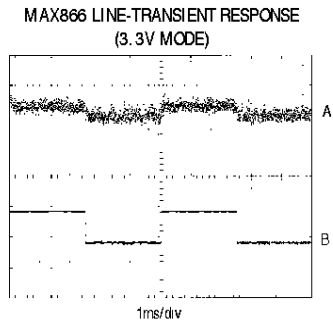
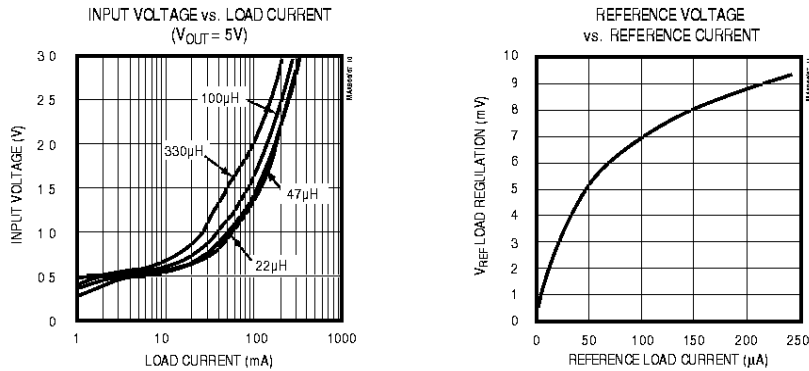
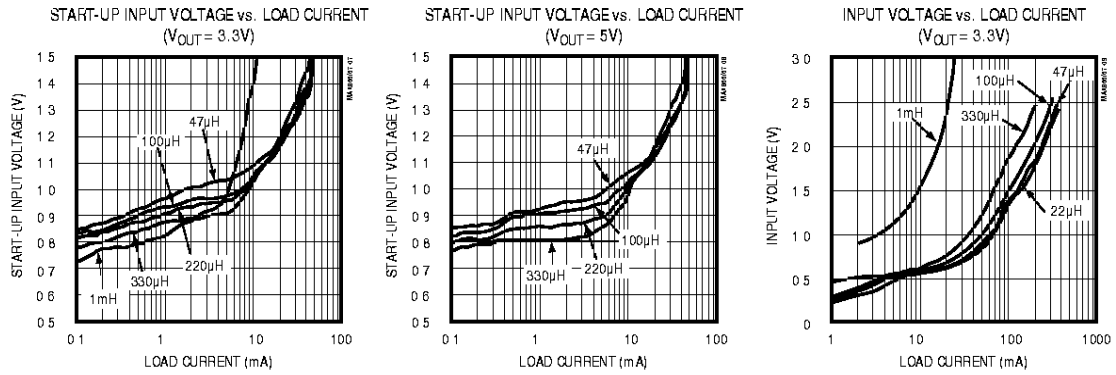

A 3.3V OUTPUT VOLTAGE, AC COUPLED 20mV/div
 B INPUT VOLTAGE (0.9V AND 1.4V) 500mV/div
 $I_{LOAD} = 10\text{mA}$, $C_{OUT} = 47\mu\text{F}$

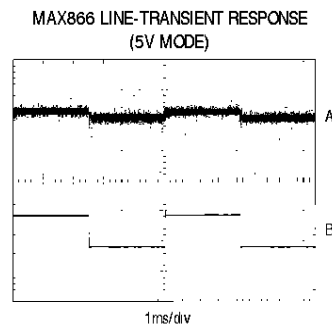

A 5.0V OUTPUT VOLTAGE, AC COUPLED 20mV/div
 B INPUT VOLTAGE (0.9V AND 1.4V) 500mV/div
 $I_{LOAD} = 10\text{mA}$, $C_{OUT} = 47\mu\text{F}$

3.3V/5V or Adjustable-Output, Single-Cell DC-DC Converters

MAX866/MAX867

Typical Operating Characteristics (continued)

(Circuits of Figure 2, $T_A = +25^\circ\text{C}$, unless otherwise noted.)

MAX866 LOAD-TRANSIENT RESPONSE
(3.3V MODE)

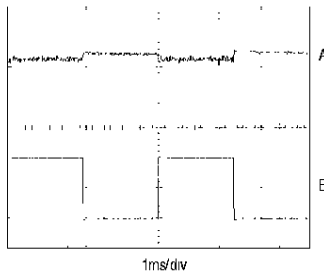

A 3.3V OUTPUT VOLTAGE, AC COUPLED 20mV/div
B OUTPUT CURRENT (0mA AND 10mA) 5mV/div
(TEKTRONIX P6042 CURRENT PROBE)
 $I_{LOAD} = 5\text{mA}$, $C_{OUT} = 47\mu\text{F}$, $V_{IN} = 1.25\text{V}$

MAX866 LOAD-TRANSIENT RESPONSE
(5V MODE)

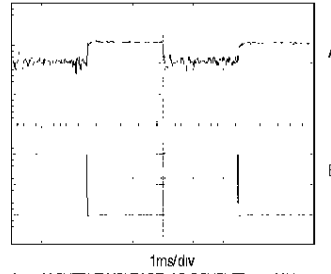

A 5.0V OUTPUT VOLTAGE, AC COUPLED 20mV/div
B OUTPUT CURRENT (0mA AND 10mA) 5mV/div
(TEKTRONIX P6042 CURRENT PROBE)
 $I_{LOAD} = 5\text{mA}$, $C_{OUT} = 47\mu\text{F}$, $V_{IN} = 1.25\text{V}$

MAX866 SHUTDOWN RESPONSE
(3.3V MODE)

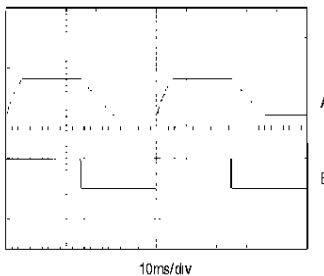

A 3.3V OUTPUT VOLTAGE, 2V/div
B SHDN INPUT VOLTAGE (0V AND 5V) 2V/div
 $I_{LOAD} = 10\text{mA}$

MAX866 SHUTDOWN RESPONSE
(5V MODE)

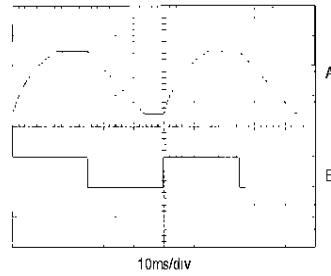

A 5.0V OUTPUT VOLTAGE, 2V/div
B SHDN INPUT VOLTAGE (0V AND 5V) 5V/div
 $I_{LOAD} = 10\text{mA}$

MAX867 LBI AND FB THRESHOLD
vs. TEMPERATURE

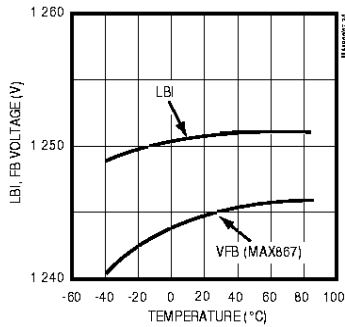

MAX866 OUTPUT VOLTAGE ERROR
vs. TEMPERATURE

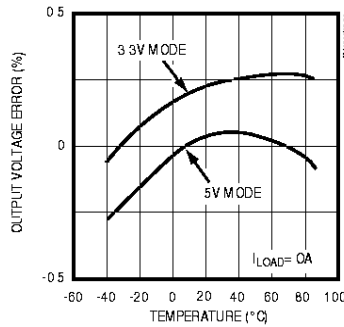

START-UP VOLTAGE
vs. TEMPERATURE

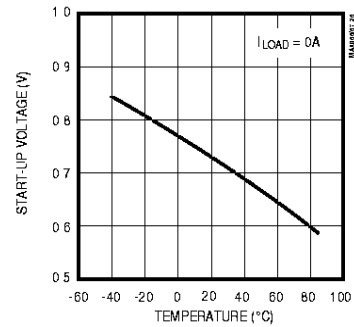

3.3V/5V or Adjustable-Output, Single-Cell DC-DC Converters

Typical Operating Characteristics (continued)

(Circuits of Figure 2, $T_A = +25^\circ\text{C}$, unless otherwise noted.)

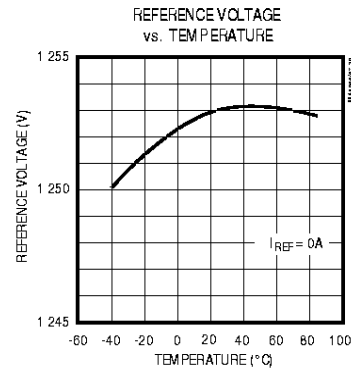
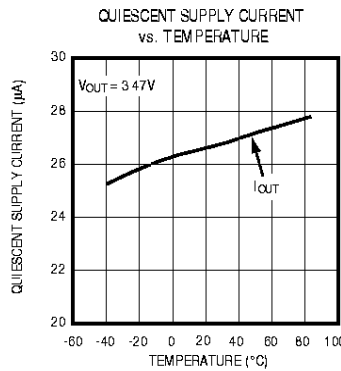
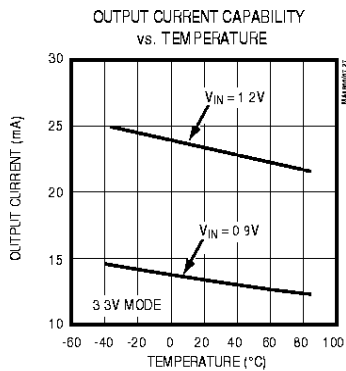

Pin Description

PIN		NAME	FUNCTION
MAX866	MAX867		
1	1	SHDN	Shutdown Input. When low, the entire circuit is off and $V_{OUT} = V_{IN} - V_D$, where V_D is the forward voltage drop of the external Schottky rectifier.
2	—	3/5	Selects the output voltage; connect to GND for 5V output, and to OUT for 3.3V output.
—	2	FB	Feedback Input for adjustable-output operation. Connect to an external resistor voltage divider between OUT and GND.
3	3	REF	1.25V Reference Voltage Output. Bypass with 0.22µF to GND (0.1µF if there is no external reference load). Maximum load capability is 250µA source, 20µA sink.
4	4	LBO	Low-Battery Output. An open-drain N-channel MOSFET sinks current when the voltage at LBI drops below 1.25V.
5	5	LBI	Low-Battery Input. When the voltage on LBI drops below 1.25V, LBO sinks current. If not used, connect to V_{IN} .
6	6	OUT	Connect OUT to the regulator output. OUT provides bootstrap power to the IC.
7	7	GND	Power Ground. Must be low impedance; solder directly to ground plane.
8	8	LX	N-Channel Power-MOSFET Drain

3.3V/5V or Adjustable-Output, Single-Cell DC-DC Converters

MAX866/MAX867

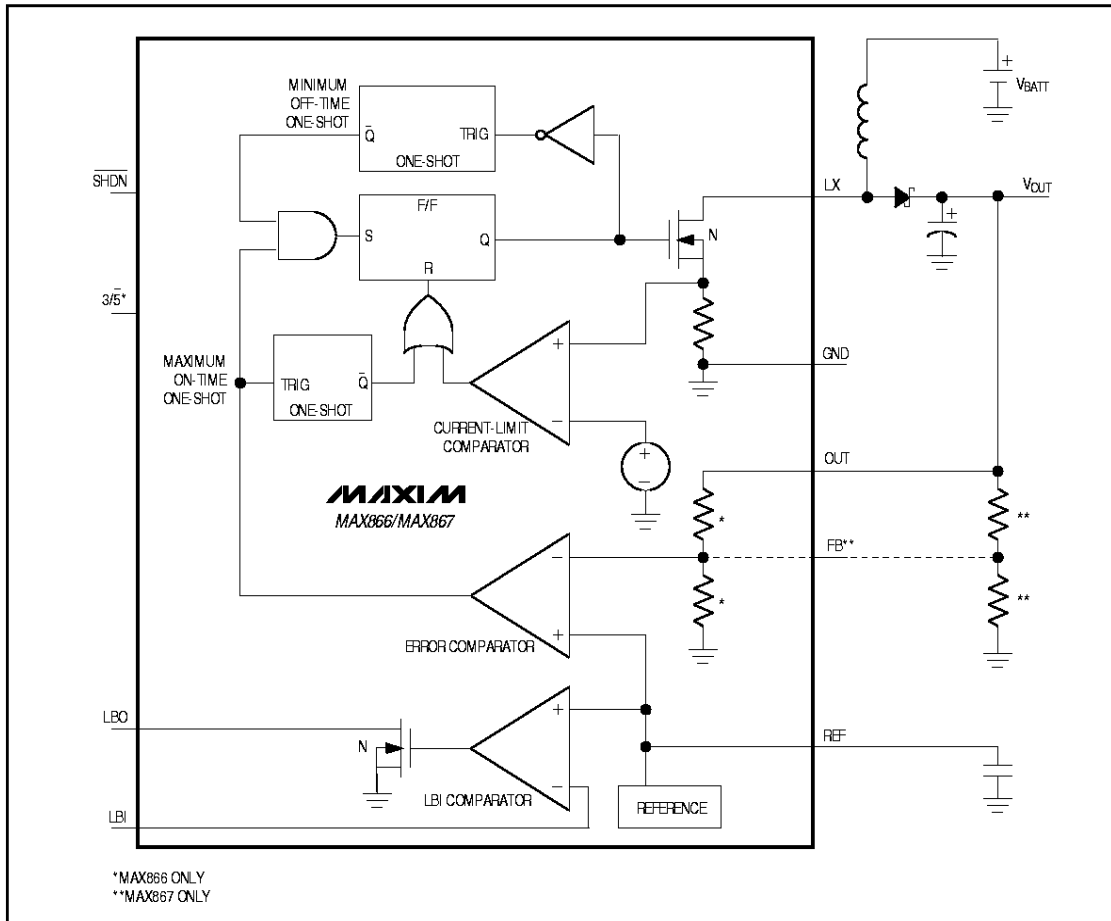

Figure 1. Block Diagram

Detailed Description

Operating Principle

The MAX866/MAX867 combine a switch-mode regulator, N-channel power MOSFET, precision voltage reference, and power-fail detector in a single monolithic device. The MOSFET is a "sense-FET" type for best efficiency, and has a very low gate threshold voltage to ensure start-up with low battery voltages (0.8V typ).

PFM Control Scheme

The MAX866/MAX867 control scheme (Figure 1) combines low-voltage efficiency (80% typ) with low battery

drain (100 μ A typ). There is no oscillator; switching is accomplished by a pair of one shots that set a maximum LX on-time (4.5 μ s typ) and a minimum LX off-time (1 μ s). LX on-time will be terminated early if the inductor current reaches 0.5A before 4.5 μ s elapses. With the standard application circuit (Figure 2a), LX current is typically less than 50mA, so LX on-time is normally not terminated by the 0.5A limit and lasts the complete 4.5 μ s. The LX on-resistance is typically 1 Ω to minimize switch losses. The MAX866/MAX867 switching frequency depends on load, input voltage, and inductor value, and it can range up to 250kHz with typical component values.

3.3V/5V or Adjustable-Output, Single-Cell DC-DC Converters

Voltage Reference

The precision voltage reference is suitable for driving external loads, such as an analog-to-digital converter. The voltage-reference output changes less than $\pm 2\%$ when sourcing up to $250\mu\text{A}$ and sinking up to $20\mu\text{A}$. If the reference drives an external load, bypass it with $0.22\mu\text{F}$ to GND. If the reference is unloaded, bypass it with at least $0.1\mu\text{F}$.

Logic Inputs and Outputs

The $3/\bar{5}$ input is internally diode clamped to GND and OUT, and should not be connected to signals outside this range. The $\overline{\text{SHDN}}$ input and LBO output (open-drain) are not clamped to $V+$ and can be pulled as high as 7V regardless of the voltage at OUT. **Do not leave control inputs ($3/\bar{5}$, LBI, or $\overline{\text{SHDN}}$) floating.**

Design Procedure

Output Voltage Selection

For the MAX866, you can select a 3.3V or 5V output voltage under logic control, or by tying $3/\bar{5}$ to GND or OUT. The MAX867's output voltage is set by two resistors, R1 and R2 (Figure 2b), which form a voltage divider between the output and FB. Use the following equation to determine the output voltage:

$$V_{\text{OUT}} = V_{\text{REF}} \left(\frac{R1 + R2}{R2} \right)$$

where $V_{\text{REF}} = 1.25\text{V}$.

To simplify resistor selection:

$$R1 = R2 \left(\frac{V_{\text{OUT}}}{V_{\text{REF}}} - 1 \right)$$

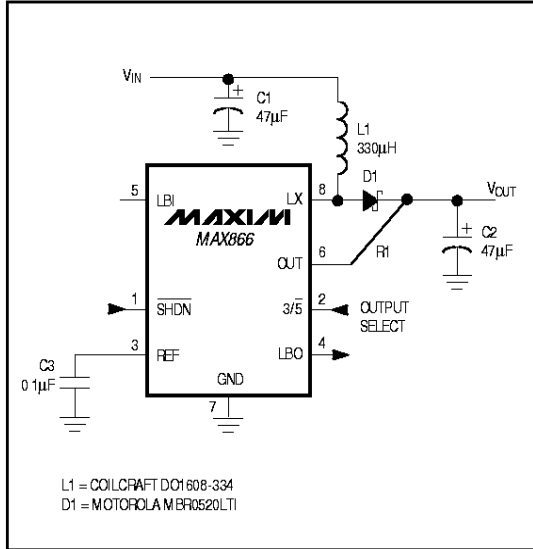

Figure 2a. Standard Application Circuit—Preset Output Voltage

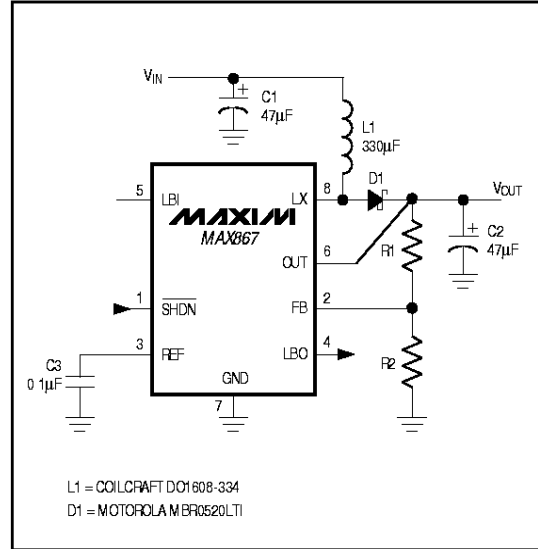

Figure 2b. Standard Application Circuit—Adjustable Output Voltage

3.3V/5V or Adjustable-Output, Single-Cell DC-DC Converters

MAX866/MAX867

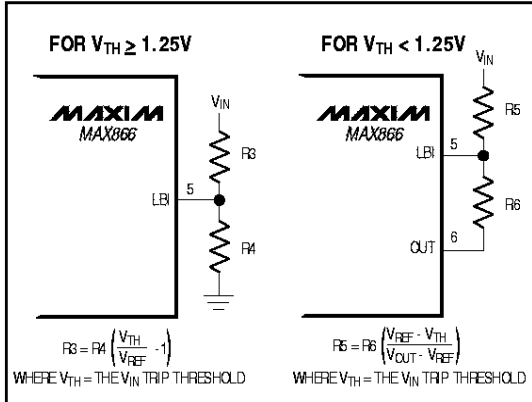

Figure 3. Low-Battery Detector Circuits

Since the input bias current at FB has a maximum value of 100nA, large values (10kΩ to 300kΩ) can be used for R1 and R2 with no significant accuracy loss. For 1% error, the current through R1 should be at least 100 times FB's bias current.

Low-Battery Detection, $V_{TH} \geq 1.25V$

The MAX866 series contains an on-chip comparator for low-battery detection. If the voltage at LBI falls below the regulator's internal reference voltage (1.25V), LBO (an open-drain output) sinks current to GND. The low-battery monitor's threshold is set by two resistors, R3 and R4 (Figure 3). Set the threshold voltage using the following equation:

$$R3 = R4 \left(\frac{V_{TH}}{V_{REF}} - 1 \right)$$

where V_{TH} is the desired threshold of the low-battery detector and V_{REF} is the internal 1.25V reference.

Since the LBI current is less than 100nA, large resistor values (typically 10kΩ to 300kΩ) can be used for R3 and R4 to minimize loading of the input supply.

When the voltage at LBI is below the internal threshold, LBO sinks current to GND. Connect a pull-up resistor of 100kΩ or more from LBO to OUT when driving CMOS circuits. When LBI is above the threshold, the LBO output is off. If the low-battery comparator is not used, connect LBI to V_{IN} and leave LBO open.

Low-Battery Detection, $V_{TH} < 1.25V$

When the low-battery detection threshold voltage is below 1.25V, use the circuit shown on the right in

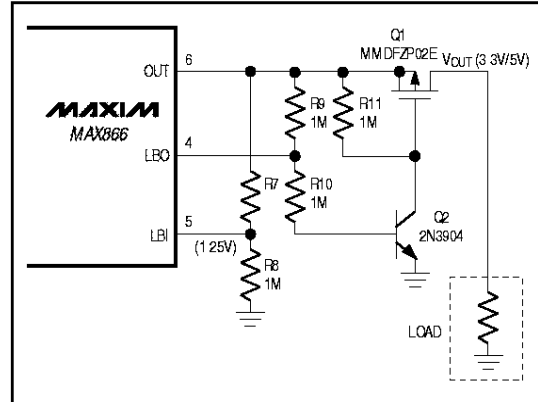

Figure 4. Low-Voltage Start-Up Circuit

Figure 3. This circuit uses V_{OUT} (3.3V or 5.0V in the MAX866, adjustable in MAX867) as a reference. The voltage divider formed by R5 and R6 allows the effective trip point of V_{IN} to be set below 1.25V. R6 is usually set to approximately 100kΩ, and R5 is given by the formula:

$$R5 = [R6 \times (V_{REF} - V_{TH})] / (V_{OUT} - V_{REF})$$

Note that LBI drops below the 1.25V LBI threshold trip point when either V_{IN} or V_{OUT} is low.

Since V_{OUT} regulation and the LBI threshold are derived from the same internal voltage reference, they track together over temperature.

Low-Battery Start-Up

The MAX866/MAX867 are bootstrapped circuits; they can start under no-load conditions at much lower battery voltages than under full load. Once started, the output can maintain a moderate load as the battery voltage decreases below the start-up voltage (see *Typical Operating Characteristics*). The circuit shown in Figure 4 allows the circuit to start with no load, then uses the LBI circuit and an external low-threshold P-channel MOSFET switch to apply the load after the output has started.

Resistors R7 and R8 are selected to trip the LBI detector at about 90% of the output voltage. On start-up, LBI and LBO are low, Q2 is off, and transistor Q1's gate is held high by R11. This disconnects the load, allowing the MAX866 to bootstrap itself at the lowest possible voltage. When the output reaches its final output voltage, LBI and LBO go high, turning on Q2, Q1, and the load.

3.3V/5V or Adjustable-Output, Single-Cell DC-DC Converters

Table 1. Component Suppliers

PRODUCTION METHOD	INDUCTORS	CAPACITORS	RECTIFIERS
Surface Mount	See Table 2	Matsuo 267 series Sprague 595D series AVX TPS series	Motorola MBR 0530 Nihon EC15QS02L
Miniature Through Hole	Sumida RCH654-220	Sanyo OS-CON series low-ESR organic semiconductor	Motorola 1N5017

COMPANY	PHONE	FAX
AVX	USA: (803) 946-0690	(803) 626-3123
Coilcraft	USA: (847) 639-6400	(847) 639-1469
Matsuo	USA: (714) 969-2491	(714) 960-6492
Motorola	USA: (602) 244-5303	(602) 244-4015
Murata-Erie	USA: (800) 831-9172	(814) 238-0490
Nihon	USA: (805) 867-2555 Japan: 81-3-3494-7411	(805) 867-2698 81-3-3494-7414
Sanyo	USA: (619) 661-6835 Japan: 81-7-2070-6306	(619) 661-1055 81-7-2070-1174
Sumida	USA: (847) 956-0666 Japan: 81-3-3607-5111	(847) 956-0702 81-3-3607-5144
TDK	USA: (847) 390-4461	(847) 390-4405
J.W. Miller	USA: (310) 515-1720	(310) 515-1962

Inductor Selection

An inductor value of 330 μ H works well in most applications, supplying loads over 10mA and allowing typical start-up voltages of 0.8V. The inductor value is not critical, and the MAX866/MAX867 can operate with values from 22 μ H to 1mH. In general, smaller inductor values supply more output current while larger values start with lower input voltage. Several inductor suppliers and part numbers are listed in Tables 1 and 2.

The peak inductor current should not exceed the inductor's current rating. Since the MAX866/MAX867 current limit of 0.5A will not be reached in most applications, the peak coil current (I_{PK}) is:

$$I_{PK} = (V_{IN(max)} \times 4.5\mu s) / L$$

For a typical 1-cell alkaline design, $V_{IN(max)}$ is 1.55V, so:

$$I_{PK} = (1.55V \times 4.5\mu s) / 330\mu H = 21.14mA$$

which is well within the ratings of most surface-mount coils. Higher efficiency and output current are achieved with lower inductor resistance, but unfortunately this is inversely related to physical size. Table 2 indicates resistance and height for each coil. Some of the smallest coils have resistances over 10 Ω , and will not provide the same output power or efficiency of a 1 Ω coil. At light loads however (below 5mA), the efficiency differences between low- and high-resistance coils may be only a percent or two. The *Typical Operating Characteristics* graphs show efficiency and output current plots for 1.5 Ω and 2.9 Ω , 330 μ H coils.

Capacitor Selection

A 47 μ F, 6V, 0.85 Ω , surface-mount tantalum (SMT) output filter capacitor typically provides 15mV output ripple when stepping up from 0.9V to 1.4V at 10mA. Smaller capacitors (down to 10 μ F with higher ESRs) are acceptable for light loads or in applications that can

3.3V/5V or Adjustable-Output, Single-Cell DC-DC Converters

MAX866/MAX867

Table 2. Surface-Mount Inductor Information

MANUFACTURER/PART	INDUCTANCE (μH)	RESISTANCE (Ω)	RATED CURRENT (A)	HEIGHT (mm)
Sumida CD73-331	330	1.5	0.28	3.5
Sumida CD104-331	330	1.1	0.42	4
Murata-Erie LQH4N331K04M00**	330	8.2	0.095	2.6
TDK NLC565050T-331K**	330	4.9	0.14	5
Coilcraft D01608-334	330	2.9	0.16	3.2
Coilcraft DT1608-334	330*	2.9	0.16	3.2
Coilcraft D03316-334	330	0.7	0.6	5.4
Coilcraft DT3316-334	330*	0.7	0.6	5.4
J.W. Miller PM105-331K	330	1.1	0.52	5.4

* Shielded

** Low cost

tolerate higher output ripple. Values in the 10μF to 47μF range are recommended.

The equivalent series resistance (ESR) of both bypass and filter capacitors affects efficiency and output ripple. Use low-ESR capacitors for best performance, or connect two or more filter capacitors in parallel. Low-ESR, SMT tantalum capacitors are currently available from Sprague (595D series) and AVX (TPS series). See Table 1 for a list of suggested capacitor suppliers.

Rectifier Diode

For optimum performance, a switching Schottky diode (such as the 1N5817 or MBR0520LTI) is recommended. Refer to Table 1 for a list of component suppliers. For low output power applications, a PN-junction switching diode (such as the 1N4148) will also work well, although its greater forward voltage drop will reduce efficiency and raise the start-up voltage.

PC Layout and Grounding

The circuit's high-frequency operation makes PC layout important for minimizing ground bounce and noise. Keep the IC's GND pin and the ground leads of C1 and C2 (Figure 2) less than 0.2in (5mm) apart. Also keep all connections to the FB and LX pins as short as possible. To maximize output power and efficiency and minimize output ripple voltage, use a ground plane and solder the IC's GND (pin 7) directly to the ground plane.

Chip Topography

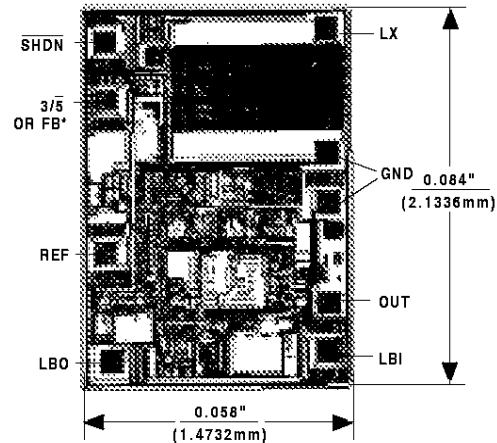

TRANSISTOR COUNT: 357;
SUBSTRATE IS CONNECTED TO OUT.

3.3V/5V or Adjustable-Output, Single-Cell DC-DC Converters

Package Information

DIM	INCHES		MILLIMETERS	
	MIN	MAX	MIN	MAX
A	0.036	0.044	0.91	1.11
A1	0.004	0.008	0.10	0.20
B	0.010	0.014	0.25	0.36
C	0.005	0.007	0.13	0.18
D	0.116	0.120	2.95	3.05
E	0.116	0.120	2.95	3.05
e	0.0256		0.65	
H	0.188	0.198	4.78	5.03
L	0.016	0.026	0.41	0.66
α	0°	6°	0°	6°

**8-PIN μMAX
MICROMAX SMALL OUTLINE
PACKAGE**

DIM	INCHES		MILLIMETERS	
	MIN	MAX	MIN	MAX
A	0.053	0.069	1.35	1.75
A1	0.004	0.010	0.10	0.25
B	0.014	0.019	0.35	0.49
C	0.007	0.010	0.19	0.25
E	0.150	0.157	3.80	4.00
e	0.050		1.27	
H	0.228	0.244	5.80	6.20
L	0.016	0.050	0.40	1.27

DIM	PINS	INCHES		MILLIMETERS	
		MIN	MAX	MIN	MAX
D	8	0.189	0.197	4.80	5.00
D	14	0.337	0.344	8.55	8.75
D	16	0.386	0.394	9.80	10.00

**Narrow SO
SMALL-OUTLINE
PACKAGE
(0.150 in.)**

21-0041A

Maxim cannot assume responsibility for use of any circuitry other than circuitry entirely embodied in a Maxim product. No circuit patent licenses are implied. Maxim reserves the right to change the circuitry and specifications without notice at any time.

12 _____ Maxim Integrated Products, 120 San Gabriel Drive, Sunnyvale, CA 94086 (408) 737-7600