



### WGF15N70SE

#### Features:

- Low Intrinsic Capacitances.
- Excellent Switching Characteristics.
- Extended Safe Operating Area.
- Unrivalled Gate Charge :Qg= 48.5nC (Typ.).
- VDSS=700V, I<sub>D</sub>=15A
- R<sub>DS(on)</sub> : 0.52 Ω (Max) @V<sub>G</sub>=10V
- 100% Avalanche Tested



TO-220F

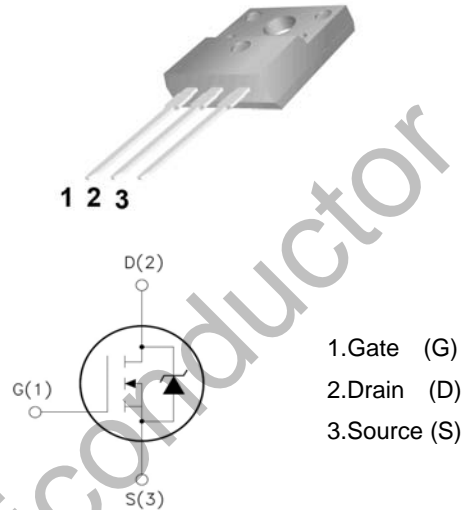

- 1.Gate (G)
- 2.Drain (D)
- 3.Source (S)

#### Absolute Maximum Ratings (Ta=25°C unless otherwise noted)

Symbol	Parameter	Value	Unit
V <sub>DSS</sub>	Drain-Source Voltage	700	V
I <sub>D</sub>	Drain Current	T <sub>C</sub> =25°C	15
		T <sub>C</sub> =100°C	9.5
V <sub>GSS</sub>	Gate - Source voltage	±30	V
E <sub>AS</sub>	Single Pulse Avalanche Energy (note1)	920	mJ
I <sub>AR</sub>	Avalanche Current (note2)	15	A
P <sub>D</sub>	Power Dissipation (Tc=25°C)	60	W
T <sub>j</sub>	Junction Temperature(Max)	150	°C
T <sub>stg</sub>	Storage Temperature	-55~+150	
TL	Maximum lead temperature for soldering purpose, 1/8" from case for 5 seconds	300	

#### Thermal Characteristics

Symbol	Parameter	Typ.	Max.	Unit
R <sub>θJC</sub>	Thermal Resistance, Junction to Case	-	2.08	°C/W
R <sub>θJA</sub>	Thermal Resistance, Junction to Ambient	-	62.5	

### Electrical Characteristics (Ta=25°C unless otherwise noted)

Symbol	Parameter	Test Condition	Min.	Typ.	Max.	Unit
<b>Off Characteristics</b>						
BV <sub>DSS</sub>	Drain-Source Breakdown Voltage	I <sub>D</sub> =250μA, V <sub>GS</sub> =0	700	-	-	V
ΔBVDSS/ΔT <sub>J</sub>	Breakdown Voltage Temperature Coefficient	I <sub>D</sub> =250μA, Reference to 25°C	-	0.71	-	V/°C
I <sub>DSS</sub>	Zero Gate Voltage Drain Current	V <sub>DS</sub> =700V, V <sub>GS</sub> =0V	-	-	10	μA
		V <sub>DS</sub> =480V, T <sub>C</sub> =125°C			100	
I <sub>GSSF</sub>	Gate-body leakage Current, Forward	V <sub>GS</sub> =+30V, V <sub>DS</sub> =0V	-	-	100	nA
I <sub>GSSR</sub>	Gate-body leakage Current, Reverse	V <sub>GS</sub> =-30V, V <sub>DS</sub> =0V	-	-	-100	
<b>On Characteristics</b>						
V <sub>GS(TH)</sub>	Gate Threshold Voltage	I <sub>D</sub> =250μA, V <sub>DS</sub> =V <sub>GS</sub>	2	-	4	V
R <sub>DS(ON)</sub>	Static Drain-Source On-Resistance	I <sub>D</sub> =7.5A, V <sub>GS</sub> =10V	-	0.45	0.52	Ω
<b>Dynamic Characteristics</b>						
C <sub>iss</sub>	Input Capacitance	V <sub>DS</sub> =25V, V <sub>GS</sub> =0, f=1.0MHz	-	2450	-	pF
C <sub>oss</sub>	Output Capacitance		-	295	-	
C <sub>rss</sub>	Reverse Transfer Capacitance		-	23.6	-	
<b>Switching Characteristics</b>						
T <sub>d(on)</sub>	Turn-On Delay Time	V <sub>DD</sub> =350V, I <sub>D</sub> =15A R <sub>G</sub> =21.7Ω (Note 3,4)	-	65	140	ns
T <sub>r</sub>	Turn-On Rise Time		-	125	260	
T <sub>d(off)</sub>	Turn-Off Delay Time		-	105	220	
T <sub>f</sub>	Turn-Off Rise Time		-	65	140	
Q <sub>g</sub>	Total Gate Charge	V <sub>DS</sub> =480V, V <sub>GS</sub> =10V, I <sub>D</sub> =15A (Note 3,4)	-	48.5	63	nC
Q <sub>gs</sub>	Gate-Source Charge		-	14	-	
Q <sub>gd</sub>	Gate-Drain Charge		-	21	-	
<b>Drain-Source Diode Characteristics and Maximum Ratings</b>						
I <sub>S</sub>	Max. Diode Forward Current	-	-	-	15	A
I <sub>SM</sub>	Max. Pulsed Forward Current	-	-	-	60	
V <sub>SD</sub>	Diode Forward Voltage	I <sub>D</sub> =15A	-	-	1.4	V
T <sub>rr</sub>	Reverse Recovery Time	I <sub>S</sub> =15A, V <sub>GS</sub> =0V diF/dt=100A/μs	496	-	-	nS
Q <sub>rr</sub>	Reverse Recovery Charge	(Note3)	5.69	-	-	μC

- Notes : 1, L=8.15mH, I<sub>AS</sub>=15A, V<sub>DD</sub>=50V, R<sub>G</sub>=25Ω, Starting T<sub>J</sub> =25°C  
 2, Repetitive Rating : Pulse width limited by maximum junction temperature  
 3, Pulse Test : Pulse Width ≤ 300μs, Duty Cycle ≤ 2%  
 4, Essentially Independent of Operating Temperature

Typical Characteristics

Figure 1. On-Region Characteristics

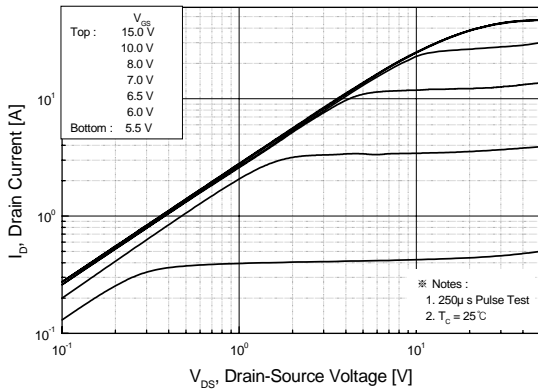

Figure 2. Transfer Characteristics

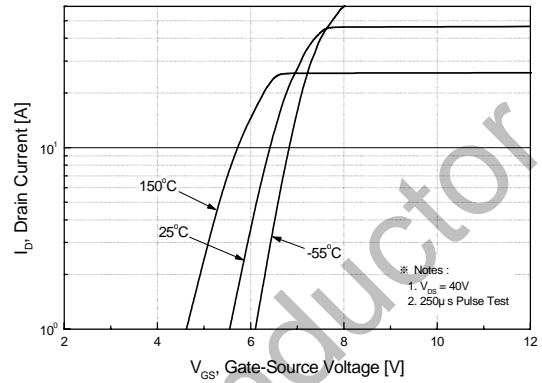

Figure 3. On-Resistance Variation vs. Drain Current and Gate Voltage

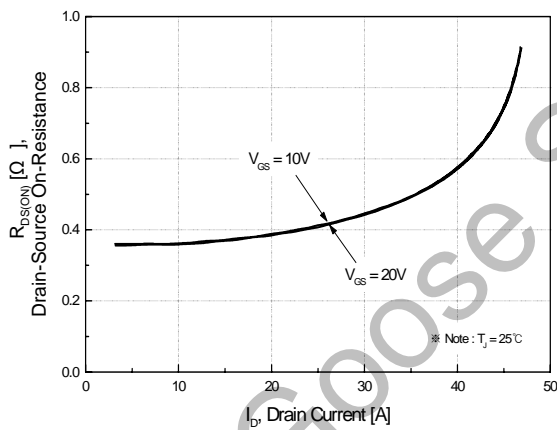

Figure 4. Body Diode Forward Voltage Variation vs. Source Current and Temperature

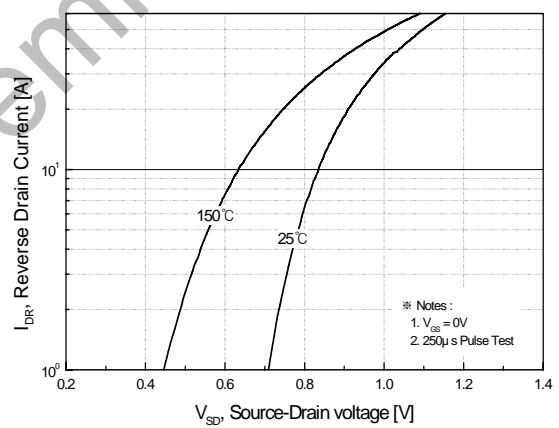

Figure 5. Capacitance Characteristics

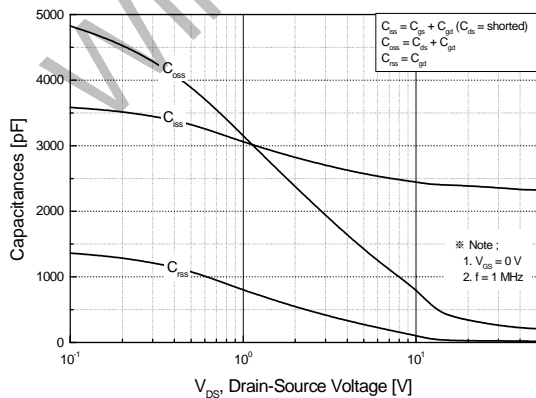
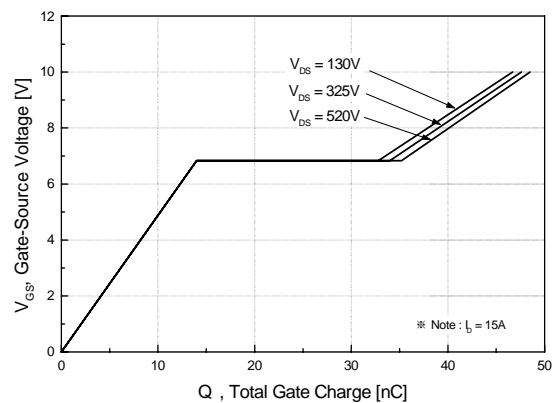

Figure 6. Gate Charge Characteristics



Typical Characteristics (Continued)

Figure 7. Breakdown Voltage Variation vs. Temperature

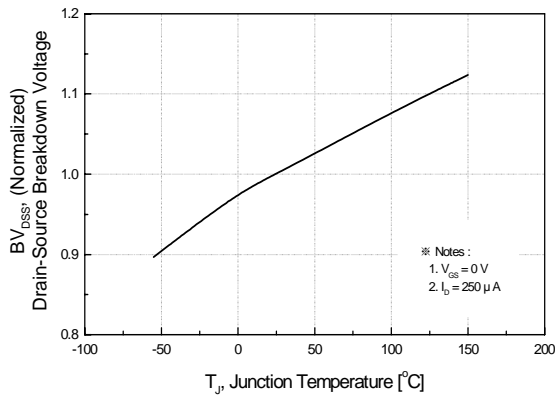

Figure 8. On-Resistance Variation vs. Temperature

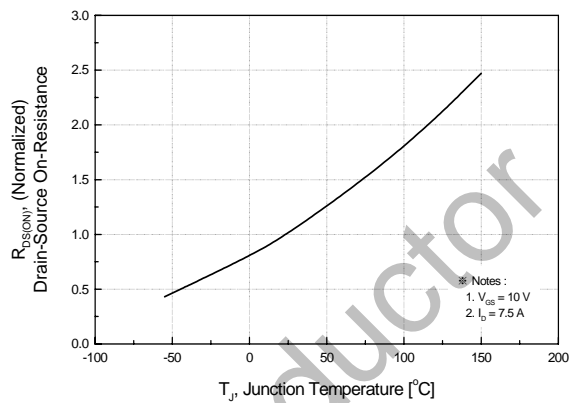

Figure 9-2. Safe Operating Area

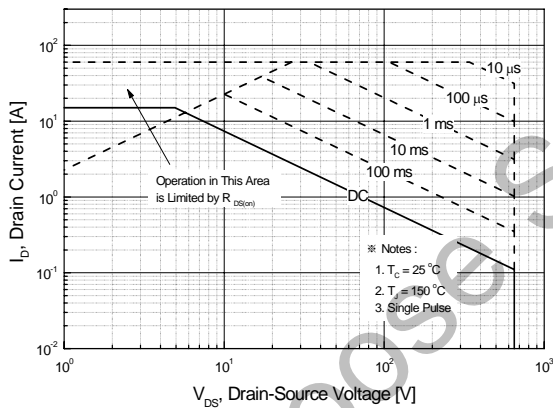

Figure 10. Maximum Drain Current vs. Case Temperature

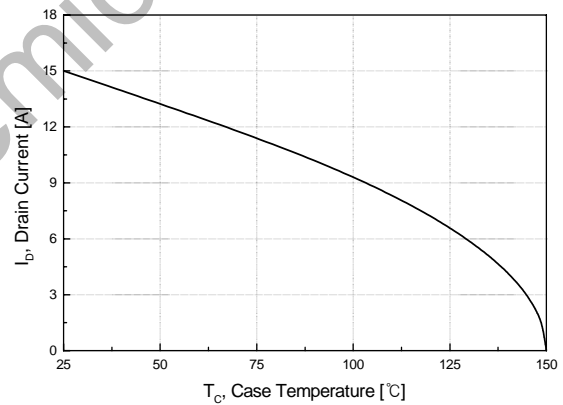
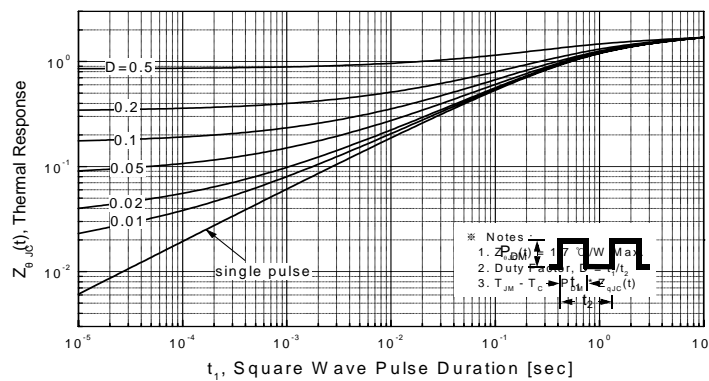
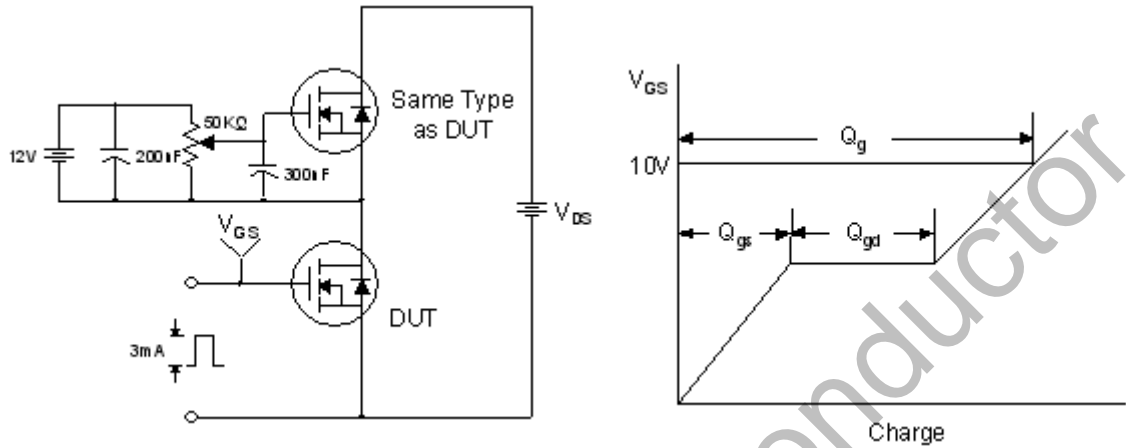

Figure 11-2. Transient Thermal Response Curve



Gate Charge Test Circuit & Waveform



Resistive Switching Test Circuit & Waveforms

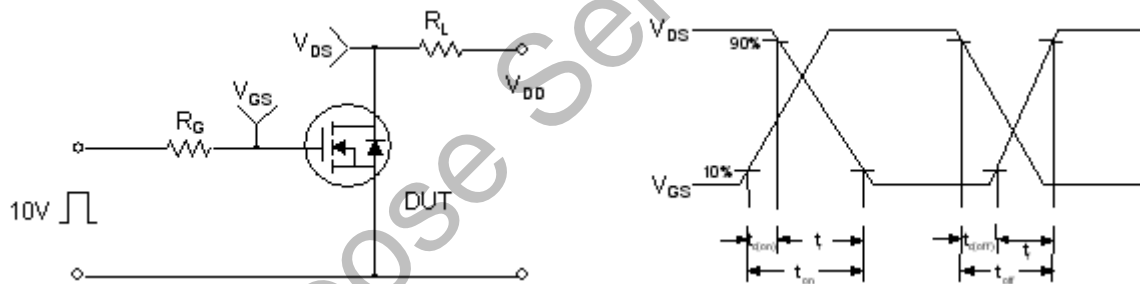

Unclamped Inductive Switching Test Circuit & Waveforms

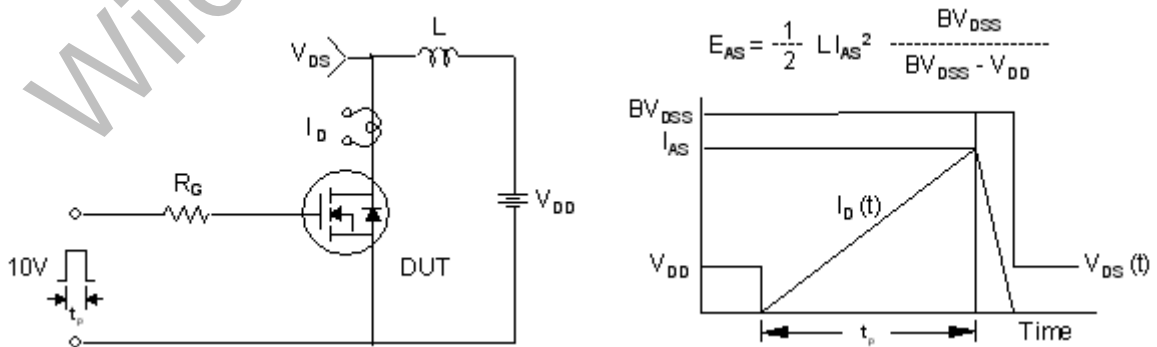

Peak Diode Recovery dv/dt Test Circuit & Waveforms

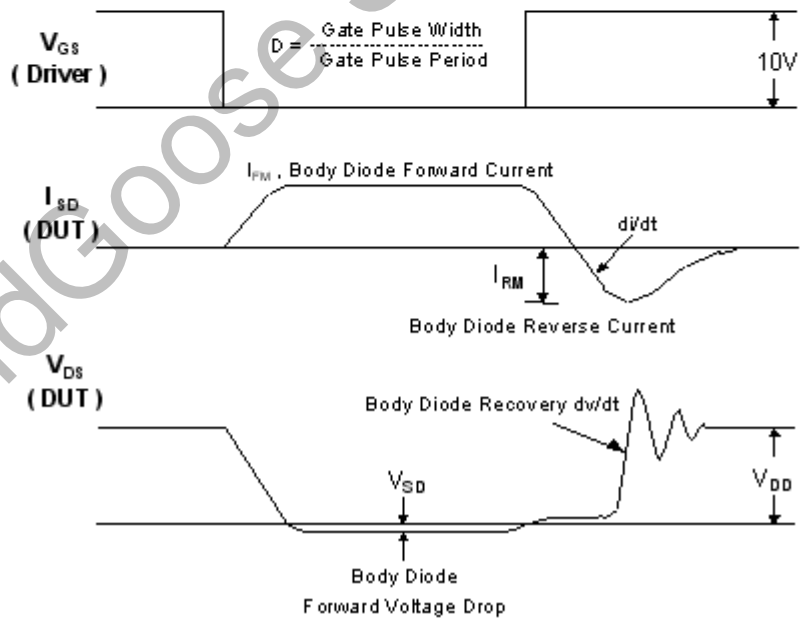
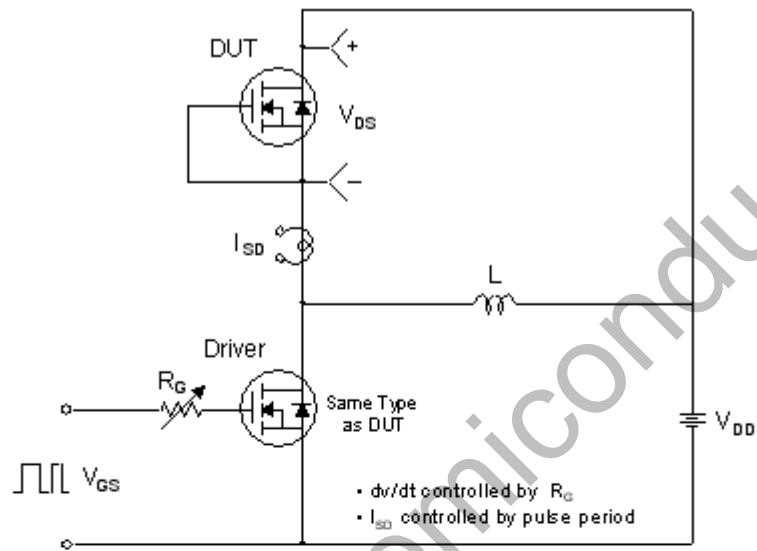

Package Dimension

TO-220F

Unit: mm

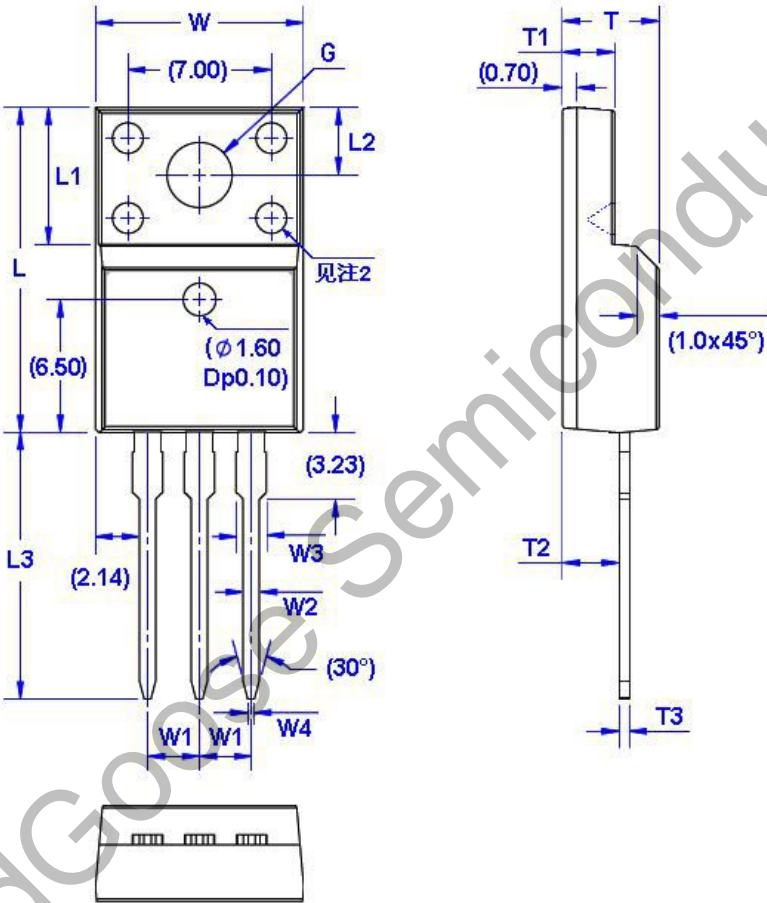

Symbol	Size		Symbol	Size		Symbol	Size		Symbol	Size	
	Min	Max		Min	Max		Min	Max		Min	Max
W	9.96	10.36	W4	0.25	0.45	L3	12.78	13.18	T3	0.45	0.60
W1	2.54 (TYP)		L	15.67	16.07	T	4.50	4.90	G( $\Phi$ )	3.08	3.28
W2	0.70	0.90	L1	6.48	6.88	T1	2.34	2.74			
W3	1.24	1.47	L2	3.20	3.40	T2	2.56	2.96			