

Description

- Advanced Process Technology
- Dynamic dv/dt Rating
- Fast Switching
- Fully Avalanche Rated
- Lead-Free
- $V_{DS}(V) = 55V$
- $I_D = 34A$ ($V_{GS} = 10V$)
- $R_{DS(ON)} < 16m\Omega$ ($V_{GS} = 10V$)

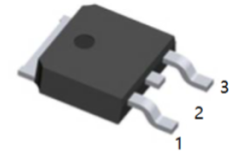

1.G 2.D 3.S
TO-252(DPAK) top view

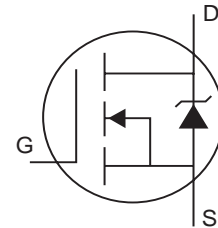

Absolute Maximum Ratings

	Parameter	Max.	Units
$I_D @ T_C = 25^\circ C$	Continuous Drain Current, $V_{GS} @ 10V$	56 [Ⓞ]	A
$I_D @ T_C = 100^\circ C$	Continuous Drain Current, $V_{GS} @ 10V$	40 [Ⓞ]	
I_{DM}	Pulsed Drain Current [Ⓛ]	220	
$P_D @ T_C = 25^\circ C$	Power Dissipation	110	W
	Linear Derating Factor	0.71	W/ [∘] C
V_{GS}	Gate-to-Source Voltage	± 20	V
E_{AS}	Single Pulse Avalanche Energy [Ⓜ]	130	mJ
I_{AR}	Avalanche Current [Ⓛ]	34	A
E_{AR}	Repetitive Avalanche Energy [Ⓛ]	11	mJ
dv/dt	Peak Diode Recovery dv/dt [Ⓜ]	5.0	V/ns
T_J	Operating Junction and	-55 to + 175	[∘] C
T_{STG}	Storage Temperature Range		
	Soldering Temperature, for 10 seconds	300 (1.6mm from case)	

Thermal Resistance

	Parameter	Typ.	Max.	Units
$R_{\theta JC}$	Junction-to-Case		1.4	[∘] C/W
$R_{\theta JA}$	Junction-to-Ambient (PCB mount)*		50	
$R_{\theta JA}$	Junction-to-Ambient		110	

Electrical Characteristics @ $T_J = 25^\circ\text{C}$ (unless otherwise specified)

	Parameter	Min.	Typ.	Max.	Units	Conditions
$V_{(BR)DSS}$	Drain-to-Source Breakdown Voltage	55			V	$V_{GS} = 0V, I_D = 250\mu A$
$\Delta V_{(BR)DSS}/\Delta T_J$	Breakdown Voltage Temp. Coefficient		0.052		V/ $^\circ\text{C}$	Reference to $25^\circ\text{C}, I_D = 1\text{mA}$
$R_{DS(on)}$	Static Drain-to-Source On-Resistance		11.8	16	$m\Omega$	$V_{GS} = 10V, I_D = 34A$ ④
$V_{GS(th)}$	Gate Threshold Voltage	2.0		4.0	V	$V_{DS} = 10V, I_D = 250\mu A$
g_{fs}	Forward Transconductance	30			S	$V_{DS} = 25V, I_D = 34A$
I_{DSS}	Drain-to-Source Leakage Current			20	μA	$V_{DS} = 55V, V_{GS} = 0V$
				250		$V_{DS} = 44V, V_{GS} = 0V, T_J = 150^\circ\text{C}$
I_{GSS}	Gate-to-Source Forward Leakage			200	nA	$V_{GS} = 20V$
	Gate-to-Source Reverse Leakage			-200		$V_{GS} = -20V$
Q_g	Total Gate Charge		70	110	nC	$I_D = 34A$
Q_{gs}	Gate-to-Source Charge		16	23		$V_{DS} = 44V$
Q_{gd}	Gate-to-Drain ("Miller") Charge		19	29		$V_{GS} = 10V$ ④
$t_{d(on)}$	Turn-On Delay Time		15		ns	$V_{DD} = 28V$
t_r	Rise Time		130			$I_D = 34A$
$t_{d(off)}$	Turn-Off Delay Time		55			$R_G = 6.8\Omega$
t_f	Fall Time		78			$V_{GS} = 10V$ ④
L_D	Internal Drain Inductance		4.5		nH	Between lead, 6mm (0.25in.) from package and center of die contact
L_S	Internal Source Inductance	—	7.5	—		
C_{iss}	Input Capacitance		2430		pF	$V_{GS} = 0V$
C_{oss}	Output Capacitance		470			$V_{DS} = 25V$
C_{rss}	Reverse Transfer Capacitance		100			$f = 1.0\text{MHz}$, See Fig. 5
C_{oss}	Output Capacitance		2040			$V_{GS} = 0V, V_{DS} = 1.0V, f = 1.0\text{MHz}$
C_{oss}	Output Capacitance		350			$V_{GS} = 0V, V_{DS} = 44V, f = 1.0\text{MHz}$
$C_{oss \text{ eff.}}$	Effective Output Capacitance ⑤		350			$V_{GS} = 0V, V_{DS} = 0V \text{ to } 44V$

Source-Drain Ratings and Characteristics

	Parameter	Min.	Typ.	Max.	Units	Conditions
I_S	Continuous Source Current (Body Diode)			56	A	MOSFET symbol showing the integral reverse p-n junction diode.
I_{SM}	Pulsed Source Current (Body Diode) ①			220		
V_{SD}	Diode Forward Voltage			1.3	V	$T_J = 25^\circ\text{C}, I_F = 34A$
t_{rr}	Reverse Recovery Time		62	93	ns	$di/dt = 100A/\mu s$ ④
Q_{rr}	Reverse Recovery Charge		170	260	nC	
t_{on}	Forward Turn-On Time	Intrinsic turn-on time is negligible (turn-on is dominated by L_S+L_D)				

Notes:

- ① Repetitive rating; pulse width limited by max. junction temperature.
- ② Starting $T_J = 25^\circ\text{C}$, $L = 0.22\text{mH}$
 $R_G = 25\Omega, I_{AS} = 34A$.
- ③ $I_{SD} \leq 34A, di/dt \leq 190A/\mu s, V_{DD} \leq V_{(BR)DSS}, T_J \leq 175^\circ\text{C}$
- ④ Pulse width $\leq 300\mu s$; duty cycle $\leq 2\%$.
- ⑤ $C_{oss \text{ eff.}}$ is a fixed capacitance that gives the same charging time as C_{oss} while V_{DS} is rising from 0 to 80% V_{DSS}
- ⑥ Calculated continuous current based on maximum allowable junction temperature. Package limitation current is 30A

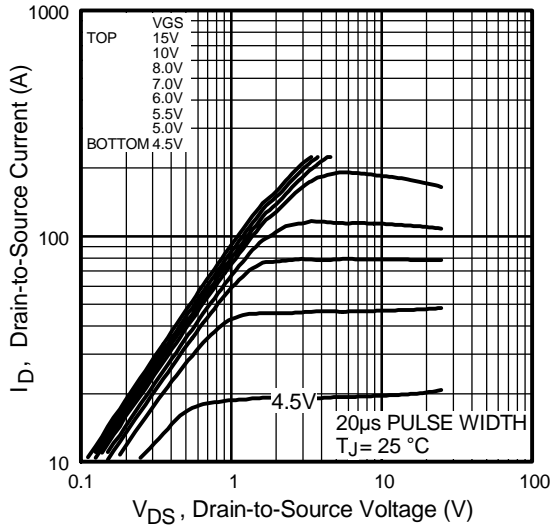

Fig 1. Typical Output Characteristics

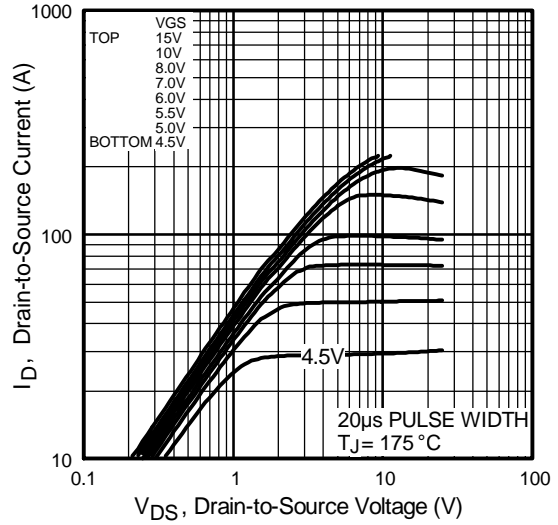

Fig 2. Typical Output Characteristics

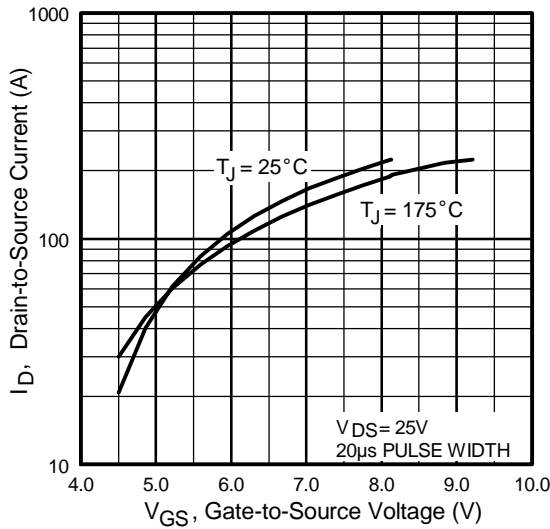

Fig 3. Typical Transfer Characteristics

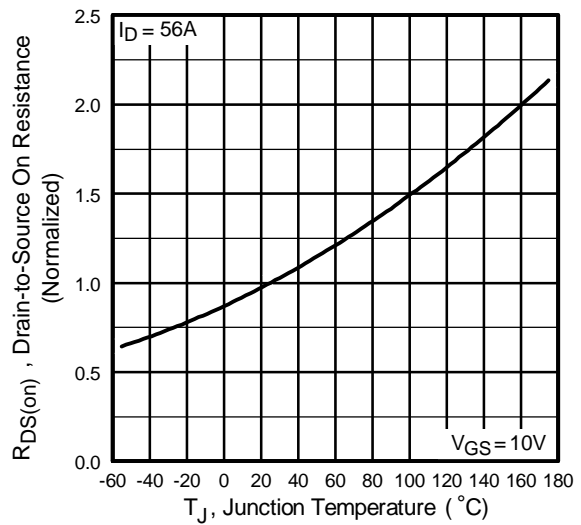

Fig 4. Normalized On-Resistance Vs. Temperature

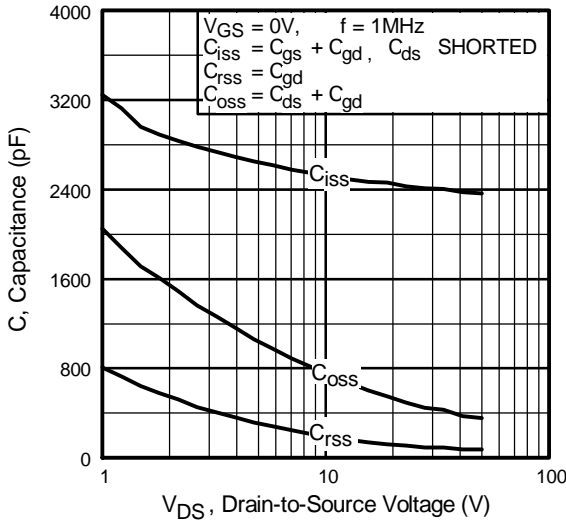

Fig 5. Typical Capacitance Vs. Drain-to-Source Voltage

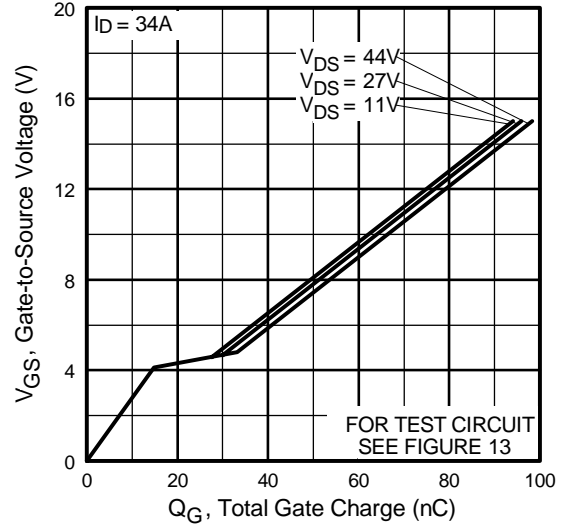

Fig 6. Typical Gate Charge Vs. Gate-to-Source Voltage

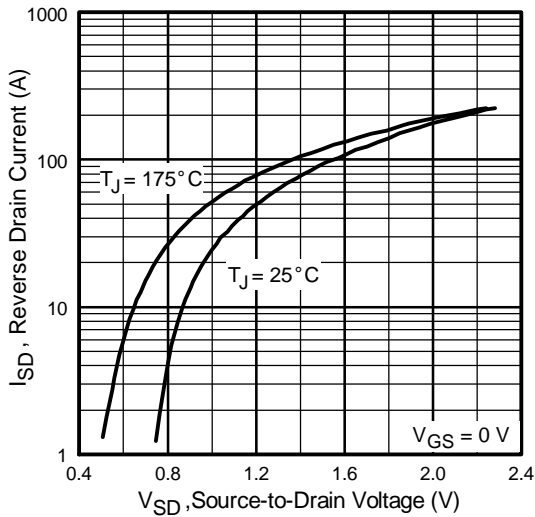

Fig 7. Typical Source-Drain Diode Forward Voltage

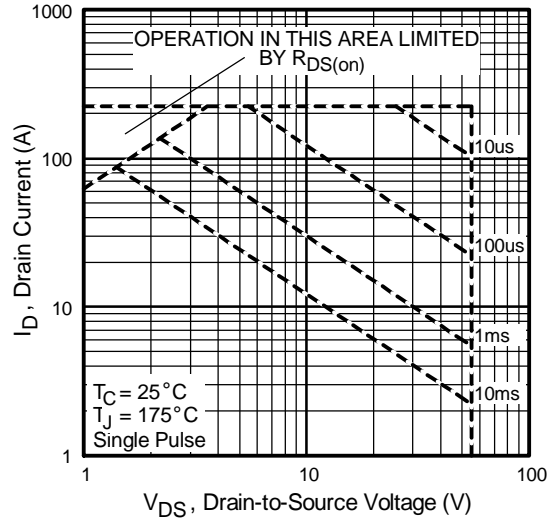

Fig 8. Maximum Safe Operating Area

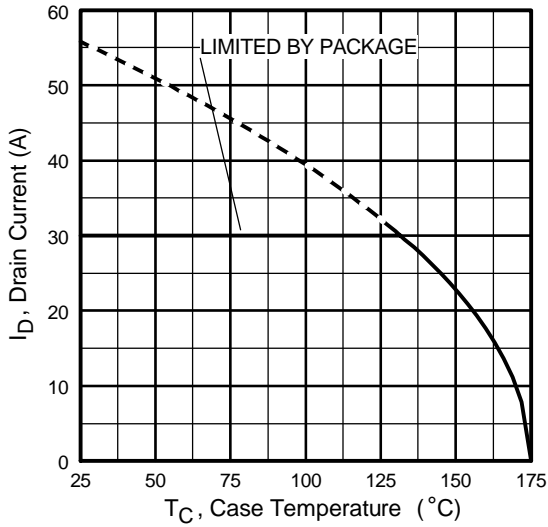

Fig 9. Maximum Drain Current Vs. Case Temperature

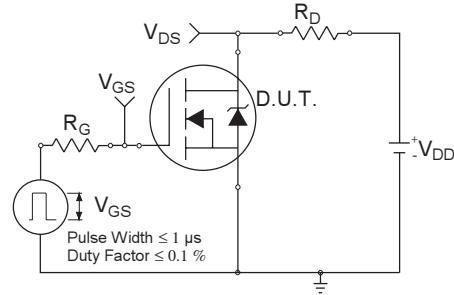

Fig 10a. Switching Time Test Circuit

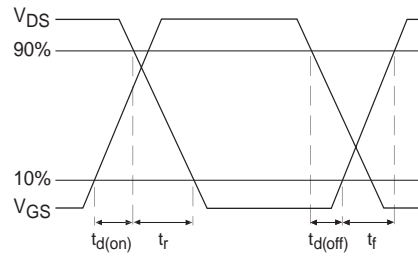

Fig 10b. Switching Time Waveforms

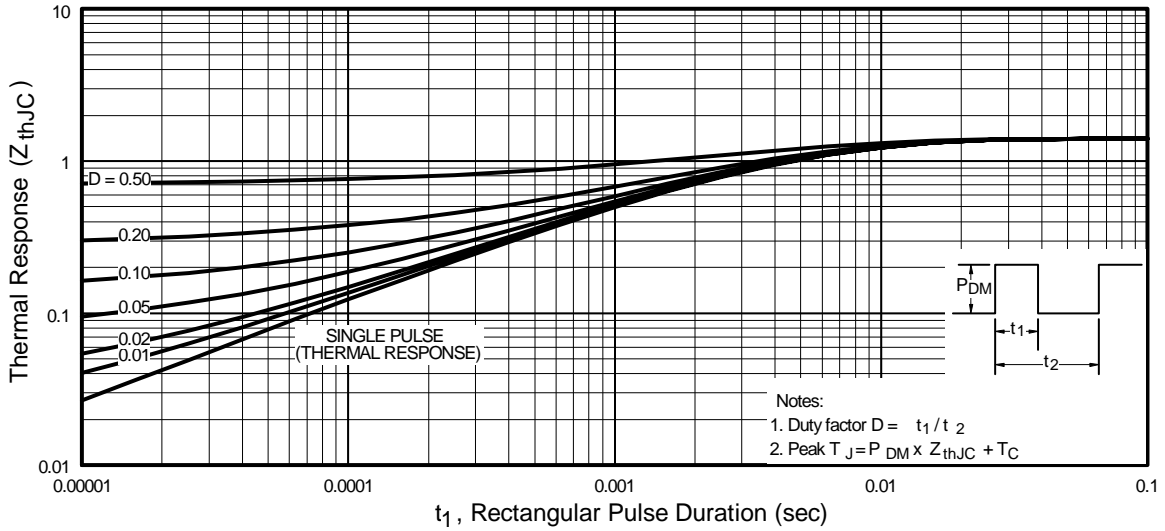

Fig 11. Maximum Effective Transient Thermal Impedance, Junction-to-Case

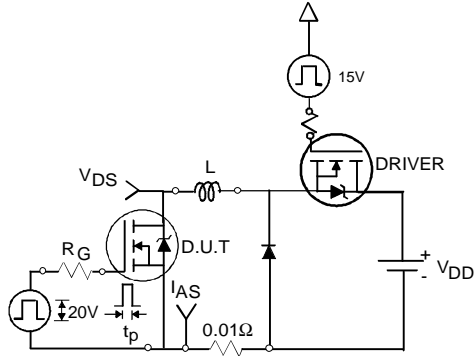

Fig 12a. Unclamped Inductive Test Circuit

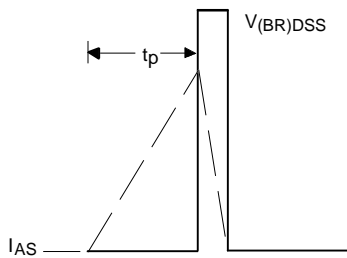

Fig 12b. Unclamped Inductive Waveforms

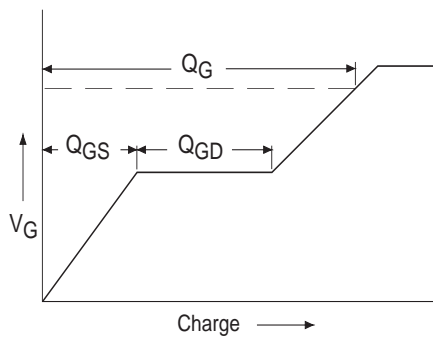

Fig 13a. Basic Gate Charge Waveform

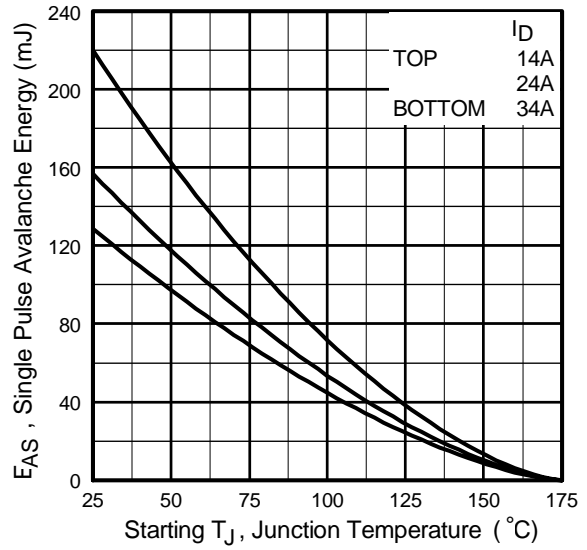

Fig 12c. Maximum Avalanche Energy Vs. Drain Current

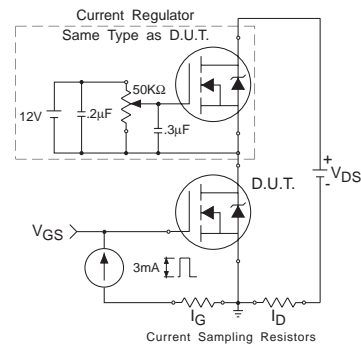
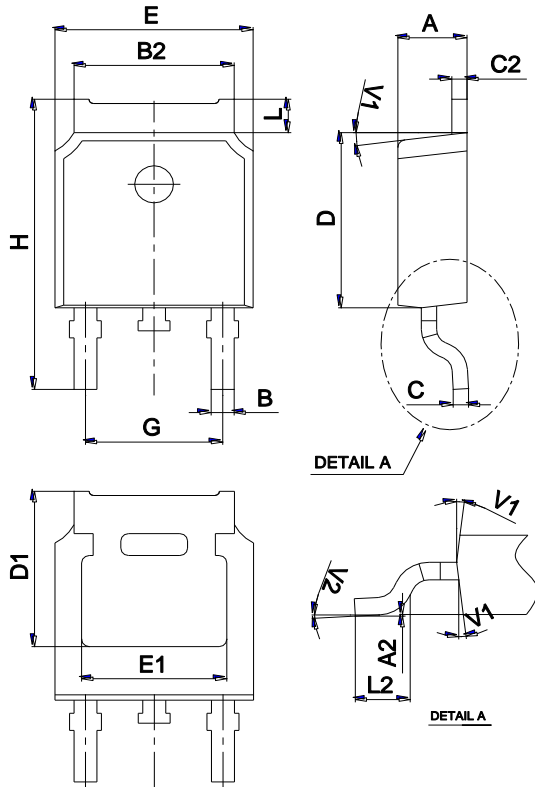

Fig 13b. Gate Charge Test Circuit

Package Mechanical Data TO-252



Ref.	Dimensions					
	Millimeters			Inches		
	Min.	Typ.	Max.	Min.	Typ.	Max.
A	2.10		2.50	0.083		0.098
A2	0		0.10	0		0.004
B	0.66		0.86	0.026		0.034
B2	5.18		5.48	0.202		0.216
C	0.40		0.60	0.016		0.024
C2	0.44		0.58	0.017		0.023
D	5.90		6.30	0.232		0.248
D1	5.30REF			0.209REF		
E	6.40		6.80	0.252		0.268
E1	4.63			0.182		
G	4.47		4.67	0.176		0.184
H	9.50		10.70	0.374		0.421
L	1.09		1.21	0.043		0.048
L2	1.35		1.65	0.053		0.065
V1		7°			7°	
V2	0°		6°	0°		6°

Marking

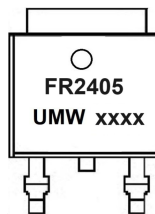

Ordering information

Order code	Package	Baseqty	Deliverymode
UMW IRFR2405TR	TO-252	2500	Tape and reel