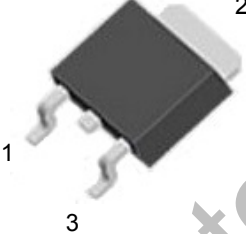
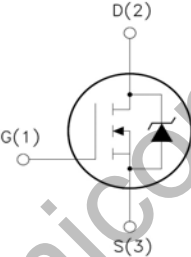

## WGD2N60SE

**Features:**

- Low Intrinsic Capacitances.
- Excellent Switching Characteristics.
- Extended Safe Operating Area.
- Unrivalled Gate Charge :Qg= 90nC (Typ.).
- BVDSS=650V,I<sub>b</sub>=2A
- R<sub>DS(on)</sub> : 4.5Ω (Max) @V<sub>G</sub>=10V
- 100% Avalanche Tested

TO-252 

1.Gate (G)

2.Drain (D)

3.Source (S)

### Absolute Maximum Ratings (Ta=25°C unless otherwise noted)

Symbol	Parameter	Value	Unit
V <sub>DSS</sub>	Drain-Source Voltage	600	V
I <sub>D</sub>	Drain Current	T <sub>C</sub> =25°C	2
		T <sub>C</sub> =100°C	1.5
V <sub>GSS</sub>	Gate-Source Voltage	±30	V
E <sub>AS</sub>	Single Pulse Avalanche Energy (note1)	120	mJ
I <sub>AR</sub>	Avalanche Current (note2)	2	A
P <sub>D</sub>	Power Dissipation (Ta=25°C)	40	W
T <sub>j</sub>	Junction Temperature(Max)	150	°C
T <sub>stg</sub>	Storage Temperature	-55~+150	
TL	Maximum lead temperature for soldering purpose, 1/8" from case for 5 seconds	300	

### Thermal Characteristics

Symbol	Parameter	Typ.	Max.	Unit
R <sub>θJC</sub>	Thermal Resistance, Junction to Case	-	2.87	°C/W
R <sub>θJA</sub>	Thermal Resistance, Junction to Ambient	-	50	

### Electrical Characteristics (Ta=25°C unless otherwise noted)

Symbol	Parameter	Test Condition	Min.	Typ.	Max.	Unit
<b>Off Characteristics</b>						
$BV_{DSS}$	Drain-Source Breakdown Voltage	$I_D=250\mu A, V_{GS}=0$	600	-	-	V
$\Delta BV_{DSS}/\Delta T_J$	Breakdown Voltage Temperature Coefficient	$I_D=250\mu A$ , Reference to 25°C	-	0.4	-	V/°C
$I_{DSS}$	Zero Gate Voltage Drain Current	$V_{DS}=600V, V_{GS}=0V$	-	-	1	$\mu A$
		$V_{DS}=520V, T_C=125^\circ C$	-	-	10	
$I_{GSSF}$	Gate-body leakage Current, Forward	$V_{GS}=+30V, V_{DS}=0V$	-	-	100	nA
$I_{GSSR}$	Gate-body leakage Current, Reverse	$V_{GS}=-30V, V_{DS}=0V$	-	-	-100	
<b>On Characteristics</b>						
$V_{GS(TH)}$	Gate Threshold Voltage	$I_D=250\mu A, V_{DS}=V_{GS}$	2	-	4	V
$R_{DS(ON)}$	Static Drain-Source On-Resistance	$I_D=1A, V_{GS}=10V$	-	3.6	4.5	$\Omega$
<b>Dynamic Characteristics</b>						
$C_{iss}$	Input Capacitance	$V_{DS}=25V, V_{GS}=0, f=1.0MHz$	-	270	350	$\mu F$
$C_{oss}$	Output Capacitance		-	40	50	
$C_{rss}$	Reverse Transfer Capacitance		-	5	7	
<b>Switching Characteristics</b>						
$T_d(on)$	Turn-On Delay Time	$V_{DD}=300V, I_D=2A, R_G=25\Omega$ (Note 3,4)	-	10	30	ns
$T_r$	Turn-On Rise Time		-	25	60	
$T_d(off)$	Turn-Off Delay Time		-	20	50	
$T_f$	Turn-Off Rise Time		-	25	60	
$Q_g$	Total Gate Charge	$V_{DS}=520V, V_{GS}=10V, I_D=2A$ (Note 3,4)	-	90	110	nC
$Q_{gs}$	Gate-Source Charge		-	1.6	-	
$Q_{gd}$	Gate-Drain Charge		-	4.3	-	
<b>Drain-Source Diode Characteristics and Maximum Ratings</b>						
$I_S$	Max. Diode Forward Current	-	-	-	2	A
$I_{SM}$	Max. Pulsed Forward Current	-	-	-	8	
$V_{SD}$	Diode Forward Voltage	$I_D=2A$	-	-	1.5	V
$T_{rr}$	Reverse Recovery Time	$I_S=2A, V_{GS}=0V$	-	180	-	ns
$Q_{rr}$	Reverse Recovery Charge	$di/dt=100A/\mu s$ (Note3)	-	0.72	-	$\mu C$

- Notes : 1, L=60mH, IAS=2A, VDD=50V, RG=25Ω, Starting TJ =25°C  
 2, Repetitive Rating : Pulse width limited by maximum junction temperature  
 3, Pulse Test : Pulse Width ≤ 300μs, Duty Cycle ≤ 2%  
 4, Essentially Independent of Operating Temperature

Typical Characteristics

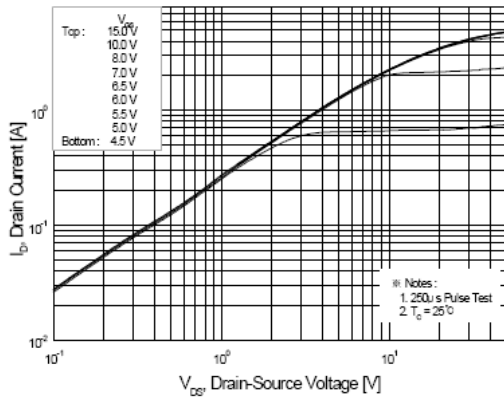

Figure 1. On-Region Characteristics

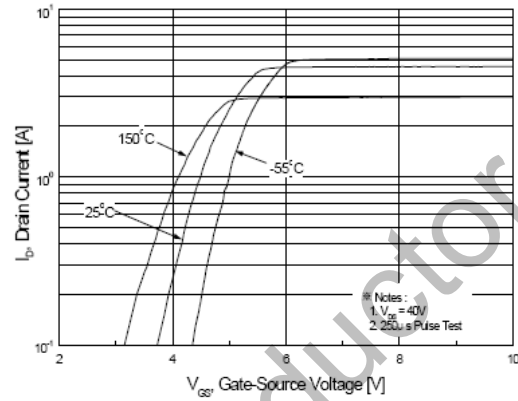

Figure 2. Transfer Characteristics

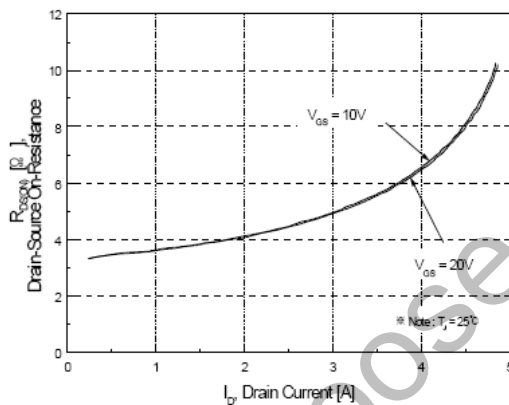

Figure 3. On-Resistance Variation vs Drain Current and Gate Voltage

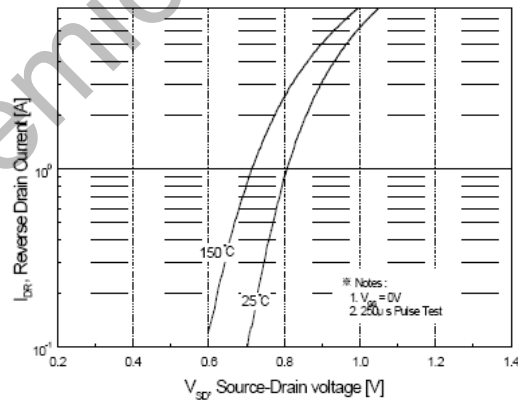

Figure 4. Body Diode Forward Voltage Variation with Source Current and Temperature

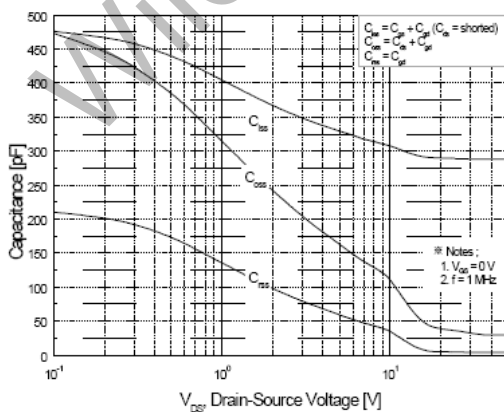

Figure 5. Capacitance Characteristics

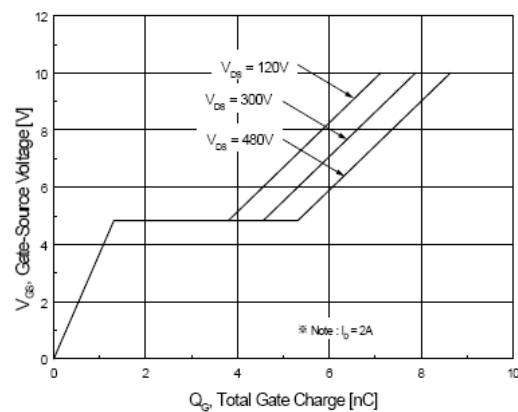

Figure 6. Gate Charge Characteristics

Typical Characteristics (Continued)

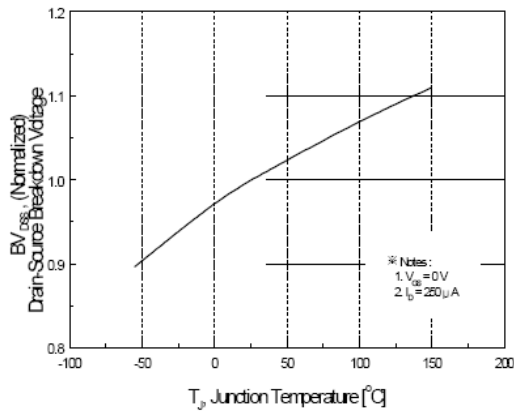

Figure 7. Breakdown Voltage Variation vs Temperature

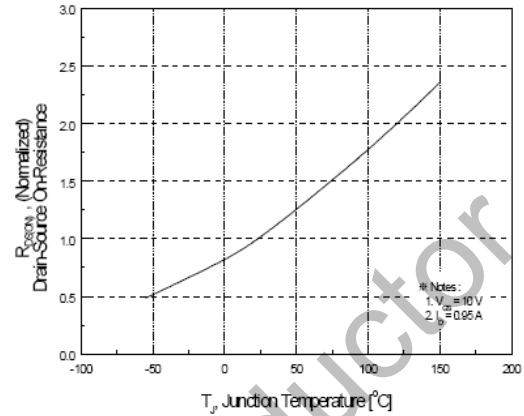

Figure 8. On-Resistance Variation vs Temperature

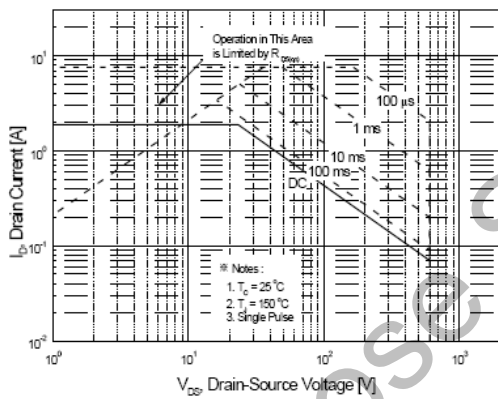

Figure 9. Maximum Safe Operating Area

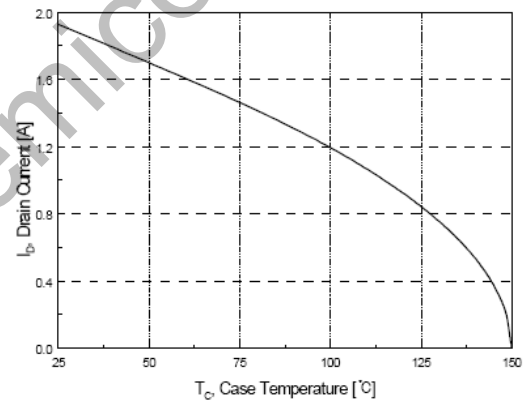

Figure 10. Maximum Drain Current vs Case Temperature

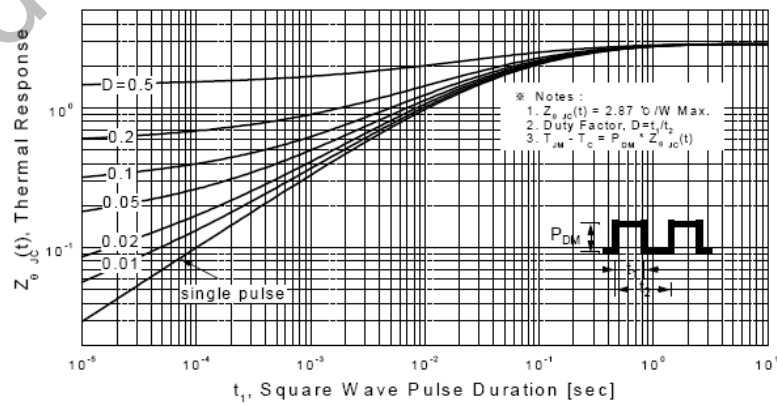
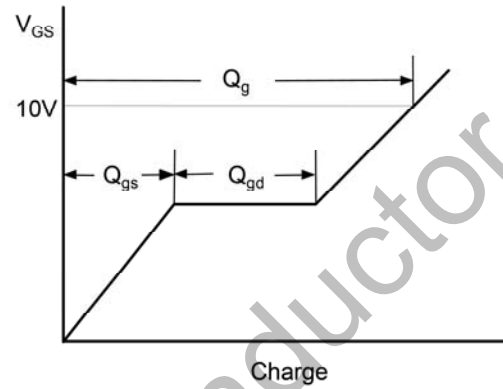
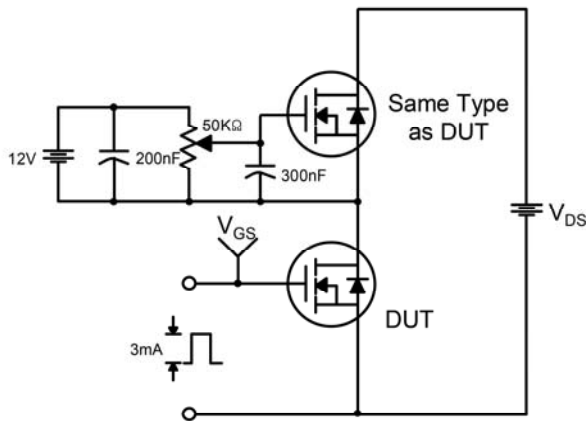
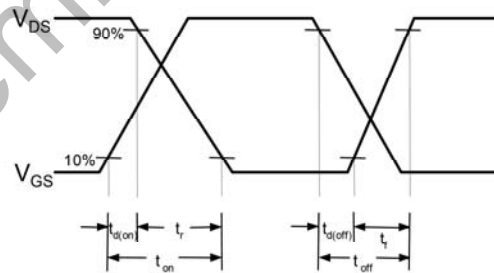
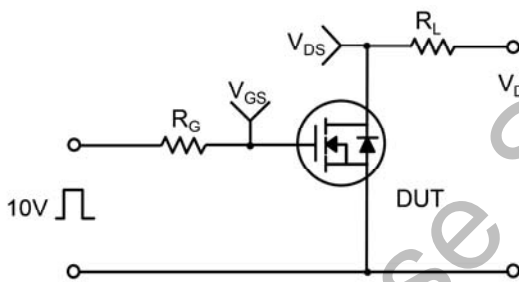

Figure 11. Transient Thermal Response Curve

**Gate Charge Test Circuit & Waveform**



**Resistive Switching Test Circuit & Waveforms**



**Unclamped Inductive Switching Test Circuit & Waveforms**

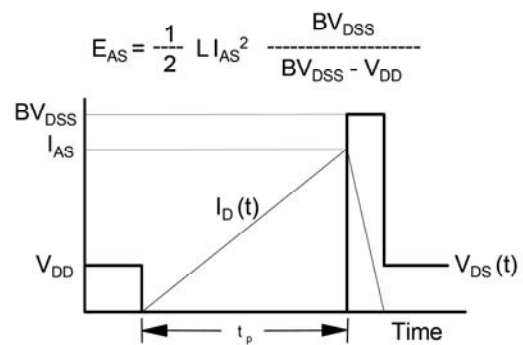
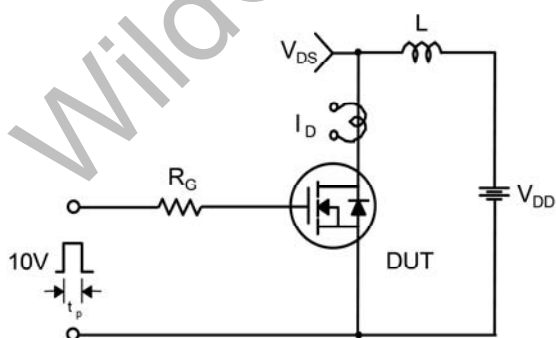

Peak Diode Recovery dv/dt Test Circuit & Waveform

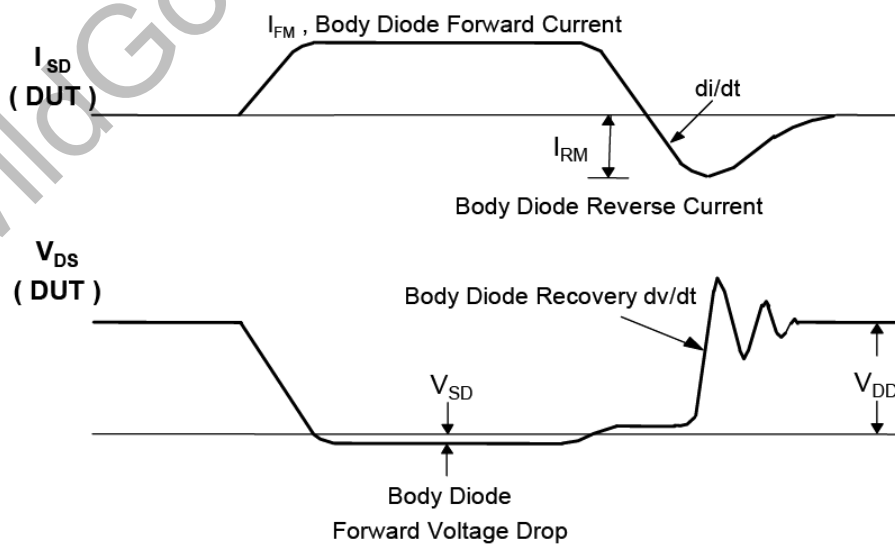
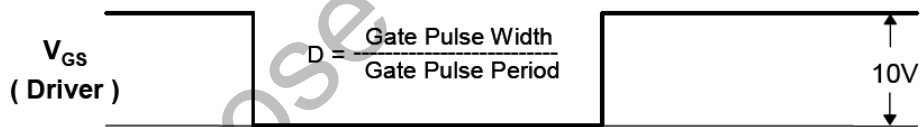
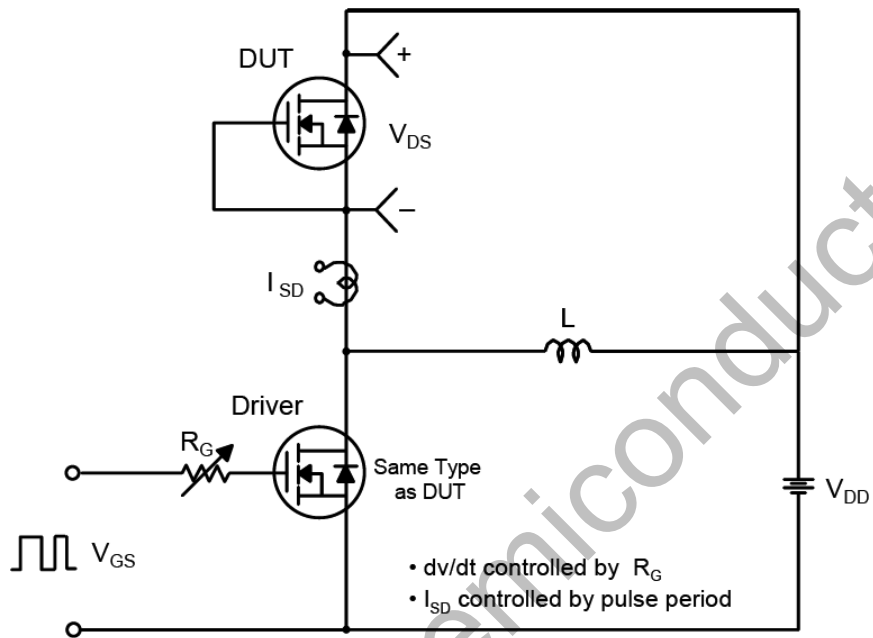

**Package Dimension**

**TO-252**

Unit: mm

